

## Analogy

An **analogy** literally means 'Drawing a comparison in order to show a **similarity in some respect**'. An analogy basically uses a relationship between two(or more) elements to show a similar relationship among another set of elements. So, these questions **aim to test overall logical understanding of the candidates and how coherently they understand the different kinds of relationships among various elements.**

There are various types of relationships which are used in analogy-based questions. Below is one such list which shows the various relationships with one example each:

Type	Example	Type	Example	Type	Example
Country & Currency	Japan: Yen	Animal/thing & Sound	Crow: Caw; Rain: Patter	Unit & Part	Pen: Nib; Blade: Fan; Book: Chapter
Instrument & Measurement	Ammeter: Current	Unit & Class	Cup: Crockery	Universal Pair	Chair: Table; Door: Window
Quantity & Unit	Power: Watt	Unit & Home	Cow: Byre	Study & Topic	Cardiology: Heart
Unit & Group	Fish: Shoal	Game & Venue	Skating: Rink; Cricket: Pitch	Word & Extreme	Quarrel: War; Speak: Shout
Animal & Baby	Deer: Fawn	Worker & Tool	Tailor: Needle; Sculptor: Chisel	Word & Synonym	Solicit: Request
Male & Female	Wizard: Witch	Tool & Action	Pen: Action	Word & Antonym	Chaos: Peace
Animal & Movement	Eagle: Swoop	Product & raw material	Oil: Seed; Metal: Ore	Worker & Working place	Actor: Stage; Mechanic: Garage

**Let's explore the various types of questions based on Analogy that are asked in SSC-CGL exams and the right way to solve them:**

### Types of Analogy:

**I). Completing analogous pair.** Such questions give the relationship between a pair; the first element of the second pair is given and we have to find the second element of the second pair based on similar relationship given by the first pair.

**For example:**

**1) Oasis: Sand :: Island: ?**

a) River

b) Sea

c) Water

d) Waves

Here, first pair is  $\Rightarrow$  "**Oasis: Sand**" and second pair is "Island:?". And, "::" sign means first pair and second pair share similar relationship.

'**Oasis**' is a mass of water amidst 'Sand' similarly 'Island' is a mass of land amidst 'water'. Note: It'd be Island: Sea had the first pair been Oasis: Desert. We're given the name of thing desert is made of i.e. Sand. So, we'll use the name of thing Sea is made of i.e. Water.

## 2) Annihilation: Fire :: Cataclysm

a) Earthquake

b) Flood

c) Emergency

d) Steam

Here, '**Annihilation**' i.e. *total destruction* is the result of 'Fire'. So, 'Cataclysm' i.e. *the rising of a body of water and its overflowing onto normally dry land* is the result of 'flood'.

**II). Simple Analogy.** In such questions a simple statement is given where a relationship is given and we're asked the second element for the term given in question, like the example below:

1) Sweet is to Chocolate as Book is to....?

a) Dictionary

b) Library

c) Encyclopedia

d) Atlas

Here, Chocolate can be sweet or bitter but 'Sweet' is the enlarged form of chocolate. Similarly, 'Encyclopedia' is an enlarged form of a 'book'.

**III). Choosing the analogous pair:** In such questions, a pair is given in the question and we've to find a suitable pair from the options given that resembles the similar relationship as in the question like the examples below:

1) Borrow : Steal

a) Enter: Trespass

b) Tell: Speak

c) Ask: Beg

d) Hit: Kill

Here, for both '**borrowing**' and 'stealing' we take someone else's thing. The only difference being that the first thing we take is with the permission of another while second thing is taken without the permission of another. Similarly, among all the options, we see this option is seen in 'Enter: Trespass' where we 'enter' after taking permit while '**trespassing**' is done without any permit whatsoever.

## 2) Cool: Frigid

a) Livid: Lurid

b) Pool: Placid

c) Tepid: Torrid

d) Lack: Abundant

Here, 'Frigid' means *extremely cold*. So, in Cool: Frigid, second is the extreme version of another. Let's check the meaning of all options given:

a) **Livid** ⇒ *Discolored beneath the skin*: Lurid ⇒ *Ghastly pale* ⇒ This doesn't give extreme version of paleness.

b) **Pool** ⇒ *A small lake* : Placid ⇒ *a body of water free from disturbance by heavy waves* ⇒ This doesn't give extreme version of pool.

c) **Tepid** ⇒ *Moderately warm*: Torrid ⇒ *Extremely hot* ⇒ Torrid is the extreme version of Tepid.

d) **Lack**: Abundant ⇒ *Present in great quantity* ⇒ These two are opposite not extreme version.

We can see that only option c) fulfils the criteria.

**IV). Multiple word analogy:** These are the type of questions discussed above with the only difference being that here three elements are given in a pair instead of two and we have to select the suitable option. Like the example below:

### 1) Music: Guitar: Performer

a) Dance: Tune: Instrument

b) Food: Recipe: Cook

c) Patient: Medicine: Doctor

d) Trick: Rope: Acrobat.

In, Music: Guitar: Performer, 'Performer' plays 'Music' on 'Guitar'. So, III element is playing/doing I element on II element.

From options, we can clearly see that this pattern is followed only in option d) i.e. Acrobat (*An athlete who performs acts requiring skill*) performs 'Tricks' on a 'Rope'.

**V). Number-based analogy:** Till now, we saw the analogy based on words now we've questions based on numbers too like shown below:

**1) Completing analogous pair.**

**25: 37 :: 49: ?**

- a) 41
- b) 56
- c) 60
- d) 65

Here, in 25: 37 the pattern can be explained as  $x^2: [(x+1)^2 + 1]$  where  $x^2$  is the first element as  $25 = 5^2$  and  $[(x+1)^2 + 1]$  is the second element as  $36 = (5+1)^2 + 1$ .

For 49, we know that  $49 = 7^2$  so second element =  $[(7+1)^2 + 1] = 65$  which is option d).

**2) Choosing the analogous pair.**

**Q. 7: 24**

- a) 30: 100
- b) 23: 72
- c) 19: 58
- d) 11: 43

In 7: 24,  $24 = 7 \times 3 + 3$  i.e. the relationship can be shown as  $x: [(x \times 3) + 3]$  Similar relationship can only be seen in option b) 23: 72 where  $23 \times 3 + 3 = 69 + 3 = 72$ .

**3) Multiple number analogy:** It's just like multiple-word analogy:

**Q. (9, 15, 21)**

- a) (10, 14, 21)
- b) (7, 21, 28)
- c) (5, 10, 25)
- d) (4, 8, 12)

In (9, 15, 21) the pattern given is  $\frac{\text{first no.} + \text{third no.}}{2} = \text{Second no.}$  as  $15 = \frac{9+21}{2} = \frac{30}{2} = 15$  where 9 and 21 are 1<sup>st</sup> and 3<sup>rd</sup> numbers respectively.

Similar relationship can only be seen in so option d) where 8 (second no.) =  $\frac{4+12}{2} = \frac{16}{2} = 8$

**VI). Alphabet based analogy.** In these types of questions, two words that are a group of random letters are related to each other in some way. We're supposed to complete the analogous pair based on that relationship:

**FJUL: BOQQ:: LHRX: ?**

- a) BKPR
- b) MNCC
- c) HRYY
- d) HMNC

The relationship between FJUL: BOQQ can be illustrated as:

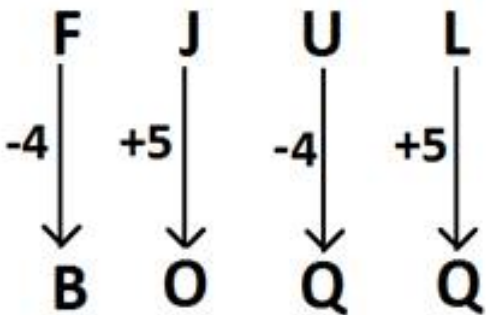

If we do a similar operation on LHRX we can see following:

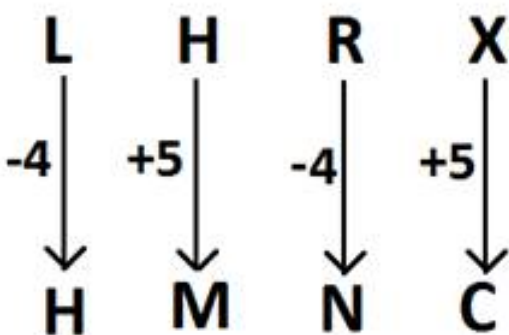

Hence, option d) is the answer.

**VII). Mixed analogy:** These types of questions mixed alphabet and number as shown below:

Q.  $\frac{T}{J} : 2 :: \frac{X}{H} : ?$

- a) 2

b) 3

c) 23/7

d) 4

Here, in  $\frac{T}{J} : 2$ , T is 20<sup>th</sup> element in the alphabet series while J is 10<sup>th</sup> so

$$\frac{T}{J} = \frac{20}{10} = 2$$

Similarly, X is 24<sup>th</sup> element in alphabetical series while H is 8<sup>th</sup> so

$$\frac{X}{H} = \frac{24}{8} = 3$$

So,  $\frac{X}{H} : 3$

## Non-Verbal Analogy Notes

### TYPE 1 - ROTATION OF FIGURE

Select a suitable figure from the Answer Figures that would replace the question mark (?).

Problem Figures:

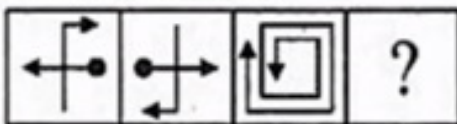

(A) (B) (C) (D)

Answer Figures:

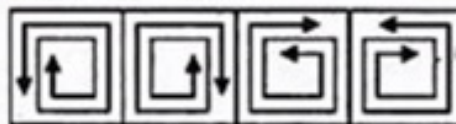

(1) (2) (3) (4)

A. 1

B. 2

C. 3

D. 4

- In this type of question, we have to find similarity in the rotation of figure. Two figures are related to each other through a specific rotation of the same figure.
- Like in the above question figure (A) is rotated **180 degrees** to obtain figure (B).
- Now we have to apply the same logic in the next two figures to obtain the answer figure.
- As we can see when we rotated the figure (C) by 180 degrees we get the figure shown in figure (2) of answer figures given.

**ANS- (B)**

### TYPE 2 - DISLOCATION OF FIGURE

Select a suitable figure from the Answer Figures that would replace the question mark (?).

**Problem Figures:**

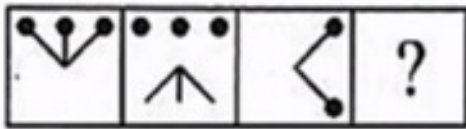

(A) (B) (C) (D)

**Answer Figures:**



(1) (2) (3) (4)

A. 1

B. 2

C. 3

D. 4

- In these types of questions, we have to see how the first figure is getting dislocated or is getting combined to get our answer figure.
- Like in the above question figure (A) is 3 dots connected with 3 straight lines but in figure (B) the dots are getting dislocated from the lines and lines get inverted.
- We have to apply the same logic to get our answer figure.
- So in our answer figure, the dots and lines must need to be disjointed from each other and line gets inverted.

So figure (C) follows this pattern hence our answer will be C

**ANS- (C)**

**TYPE 3 - INTERCHANGE OF IMAGES**

Select a suitable figure from the Answer Figures that would replace the question mark (?).

**Problem Figures:**



(A) (B) (C) (D)

**Answer Figures:**



(1) (2) (3) (4)

A. 1

B. 2

C. 3

D. 4

- In these types of questions, images get interchanged from one another to get the other image.
- Like in the above question, in figure (A) circle is at the corner of the square and in figure (B) circle takes the position of the square and vice versa.
- So we have to apply the same logic to get our answer figure.
- Figure (C) is the combination of triangle and three line
- So in our answer figure, the position of lines and triangle must be interchanged. This can be seen in figure (1)

**ANS- (A)**

Further questions are framed using these three concepts or the combination of any two mostly.

# Analogy

---

## Analogy

1. Select the option that is related to the third word in the same way as the second word is related to the first word.

**Mouse : Mice :: Datum : ?**

- a) Dates
- b) Data
- c) Datums
- d) Deity

2. Select the option that is related to the third word in the same way as the second word is related to the first word.

**Formulae : Formula :: Syllabi : ?**

- a) Syllables
- b) Syllabie
- c) Syllabus
- d) Seales

3. Select the option that is related to the third word in the same way as the second word is related to the first word.

**Wolves : Pack :: Teachers : ?**

- a) Galaxy
- b) Flock
- c) Professor

d) Faculty

4. '**Cardiologist**' is related to '**heart**' in the same way as '**Neurologist**' is related to '\_\_\_\_\_'.  
\_\_\_\_\_

- a) Neuron
- b) Ears
- c) Nose
- d) Brain

5. Select the option that is related to the third number in the same way as the second number is related to the first number.

**484 : 22 : 4096 : ?**

- a) 32
- b) 64
- c) 62
- d) 34

6. '**Astronomy**' is related to '**Stars**' in the same way as '**Agronomy**' is relate to '\_\_\_\_\_'.  
\_\_\_\_\_

- a) Fertilizers
- b) Pesticides
- c) Crops
- d) Pulses

7. Select the option that is related to the third number in the same way as the second number is related to the first number.

**8 : 576 : 13 : ?**

- a) 1396
- b) 2346
- c) 2366
- d) 2126

8. Select the option that is related to the third word in the same way as the second word is related to the first word.

**Grape : Fruit : Turmeric : ?**

- a) Vegetable
- b) Dates
- c) Spices
- d) Cereals

9. Select the option that is related to the third number in the same way as the second number is related to the first number.

**4 : 80 :: 9 : ?**

- a) 190
- b) 270
- c) 145
- d) 810

10. Select the option that is related to the third word in the same way as the second word is related to the first word.

**Small : Size : Triangle : ?**

- a) Shape

b) Area

c) Trigonometry

d) Oval

11. Select the option that is related to the fourth term in the same way as the first term is related to the second term.

**14 : 144 : ? : 289**

- a) 17
- b) 19
- c) 21
- d) 15

12. Select the option in which the words share the same relationship as that shared by the given pair of words.

**GJSY : HVMX : TRWD : ?**

- a) UZUC
- b) UUZC
- c) ZUUC
- d) CZUX

13. Select the option that is related to the fourth term in the same way as the first term is related to the second term.

**25 : 576 :: ? : 169**

- a) 13
- b) 15
- c) 14
- d) 16

14. 'Eyes' is related to 'Cataract' in the same way as 'Skin' is related to '\_\_\_\_\_'

- a) Diabetes
- b) Eczema
- c) Malaria
- d) Elephantiasis

15. Select the option in which the words share the same relationship as that shared by the given pair of words.

**Puducherry : Union territory :: ? : State**

- a) Kolkata
- b) Bhutan
- c) Chandigarh
- d) Karnataka

16. Select the option that is related to the third number in the same way as the second number is related to the first number.

**11 : 1452 :: 10 : ?**

- a) 9000
- b) 1210
- c) 1010
- d) 1100

17. Select the option that is related to the Fourth letter-cluster in the same way as the first letter-cluster is related to the second letter-cluster.

**QRYU : TOBS :: ? : FG TN**

- a) IDWK
- b) CJQQ
- c) CQJQ
- d) IWDK

18. Select the option in which the words share the same relationship as that shared by the given pair of words.

**Mobile : Telecommunication : ? : Transportation**

- a) Petrol
- b) Train
- c) Diesel
- d) Postcard

19. Select the option that is related to the third letter-cluster in the same way as the second letter-cluster is related to the first letter-cluster.

**ASKLJ : CVOQP : WOIDN : ?**

- a) YRMIT
- b) YMRIT
- c) YRIMT
- d) YQMIT

20. 'Snake' is related to 'Reptile' in the same way as 'Toad' is related to '\_\_\_\_\_'

- a) Mammal
- b) Amphibians
- c) Reptile
- d) Arachnid

21. 'Ears' is related to 'Pinna' in the same way as 'Eyes' is related to '\_\_\_\_\_'

- a) Lid
- b) Vision
- c) Anvil
- d) Cornea

22. Select the option that is related to the third number in the same way as the second number is related to the first number.

**9 : 504 : 11 : ?**

- a) 1281
- b) 999
- c) 990
- d) 1099

23. Select the option that is related to the third word in the same way as the second word is related to the first word.

**Pencil : Stationery :: Spoon : ?**

- a) Dish
- b) Tool
- c) Utensil
- d) Coffee

24. Select the option that is related to the third letter-cluster in the same way as the second letter cluster is related to the first letter-cluster.

**FDKL : UWPO :: NAME : ?**

- a) MZNV
- b) MNZV
- c) NMVZ
- d) MBNV

25. Select the option that is related to the Fourth letter-cluster in the same way as the first letter-cluster is related to the second letter-cluster.

**DOCTOR : ALZQLO :: ? : KROPB**

- a) STAFF
- b) PANEL
- c) PATEN
- d) NURSE

26. Select the option that is related to the third term in the same way as the second term is related to the first term.

**MAN : QER :: GUN : ?**

- a) KYC
- b) KYR
- c) YKR
- d) RYK

27. 'Nymph' is related to 'Cockroach' in the same way as 'Lamb' is relate to '\_\_\_\_\_'

- a) Sheep
- b) Rhinoceros
- c) Rabbit
- d) Lion

28. 'Dawn' is related to 'Dusk' in the same way as 'Night' is relate to '\_\_\_\_\_'

- a) Dark
- b) Noon
- c) Day
- d) Evening

29. Select the option that is related to the third number in the same way as the second number is related to the first number.

**112 : 126 :: 120 : ?**

- a) 136
- b) 150
- c) 135
- d) 122

30. Select the option that is related to the third letter-cluster in the same way as the second letter cluster is related to the first letter-cluster.

**SAUCE : ASXEC : LEMON : ?**

- a) LEQNO
- b) ELPNO
- c) ELQON
- d) ELRNO

31. Select the option that is related to the third word in the same way as the second word is related to the first word.

**Finance : Nirmala Sitharaman :: ? : Subrahmanyam Jaishankar**

- a) Social Justice and Empowerment
- b) External Affairs
- c) Tribal Affairs
- d) Home Affairs

32. Select the option that is related to the third number in the same way as the second number is related to the first number.

**13 : 2196 :: 9 : ?**

- a) 728
- b) 729

c) 730

d) 727

33. Select the option that is related to the third word in the same way as the second word is related to the first word.

**ASSUME : TBVTFN :: LOCUST : ?**

- a) PMVUDT
- b) PVMDUT
- c) PMVDUT
- d) PMDVUT

34. 'Bones' is related to 'Skeleton' in the same way as 'Bricks' is relate to '\_\_\_\_\_'

- a) Surface
- b) Dust
- c) Sand
- d) House

35. 'Lizard' is related to 'reptile' in the same way as 'bat' is relate to '\_\_\_\_\_'

- a) Amphibian
- b) Mammal
- c) Reptile
- d) Insect

36. '52' is related to '7' in the same way as '84' is relate to '\_\_\_\_\_'

- a) 11
- b) 9
- c) 13

d) 17

37. Select the option that is related to the third word in the same way as the second word is related to the first word.

**Force : Newton :: Pressure : ?**

a) Erg

b) Pascal

c) Bar

d) Joule

38. 'RUSKIN' is related to 'IFHPRM' in the same way as 'SHAKIRA' is relate to '\_\_\_\_\_'

a) HSZRPIZ

b) SHZPRIZ

c) HSZPRIZ

d) HSZPIRZ

39. Select the option that is related to the third letter-cluster in the same way as the second letter-cluster is related to the first letter-cluster.

**GDP : IFR :: MAN : ?**

a) OCP

b) PCO

c) ODP

d) OAK

40. '11' is related to '242' in the same way as '8' is relate to '\_\_\_\_\_'

a) 64

b) 512

c) 128

d) 1024

41. 'Sculptor' is related to 'Chisel' in the same way as 'Surgeon' is relate to '\_\_\_\_\_'

a) Hammer

b) Iron

c) Probes

d) Scalpel

42. Select the option that will come next in the given series.

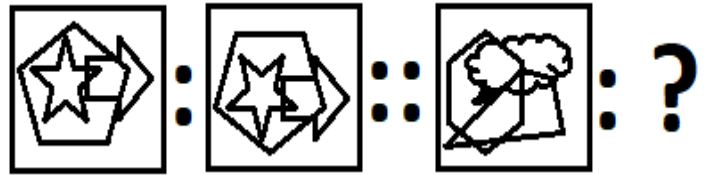

a)



b)



c)





d)

43. Select the number-pair in which the two numbers are related in the same way as are the two numbers of the given number pair.

**125 : 343 :: 729 : ?**

- a) 121
- b) 1331
- c) 1221
- d) 484

44. 'Winter' is related to 'Season' in the same way as 'Tuesday' is relate to '\_\_\_\_\_'

- a) Date
- b) Leap Year
- c) Week
- d) Day

45. Select the option that is related to the third letter-cluster in the same way as the second letter-cluster is related to the first letter-cluster.

**TRUE : GTVX :: DUPE : ?**

- a) GSWF
- b) HWFS
- c) GWSF
- d) FSWG

46. Select the option that is related to the fourth image in the same way as the second image is related to the first image.

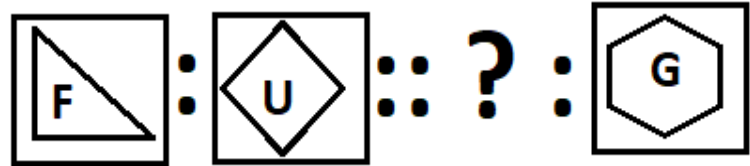

a)



b)

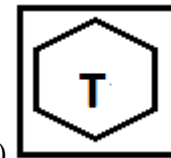

c)



d)

47. Select the option that is related to the third word in the same way as the second word is related to the first word.

**Temperature : Fahrenheit :: Time : ?**

- a) Seconds
- b) Unit
- c) Einstein
- d) Light Year

48. Select the option that is related to the third number in the same way as the second number is related to the first number.

**25 : 105 :: 55 : ?**

- a) 255
- b) 505
- c) 231
- d) 285

49. In the following question, select the related word from the given alternatives.

**Adequate : Enough :: Cuffs : ?**

- a) Interim
- b) Bonds
- c) Obstacle
- d) Absolute

50. 'Rough' is related to 'Smooth' in the same way as 'Attenuate' is related to '\_\_\_\_\_'

- a) Shiver
- b) Weak
- c) Feeble
- d) Strong

## ANSWERS

**1) Answer: B**

The plural form of Mouse is Mice.

The plural form of Datum is Data.

**2) Answer: C**

The singular form of formulae is formula.

The singular form of syllabi is syllabus.

**3) Answer: D**

A pack of wolves. (Collective noun)

A faculty of teachers. (Collective noun)

**4) Answer: D**

A cardiologist is a *doctor* with special training and skill in finding, treating and preventing diseases of the *heart* and blood vessels.

A neurologist is a medical doctor who specializes in treating diseases of the nervous system. The nervous system is made of two parts: the central and peripheral nervous system. It includes the brain and spinal cord.

**5) Answer: B**

$$22^2 = 484$$

$$64^2 = 4096$$

**6) Answer: C**

**Astronomy** is the scientific study of celestial objects (such as stars, planets, comets, and galaxies) and phenomena that originate outside the Earth's atmosphere (such as the cosmic background radiation).

**Agronomy** is the science and technology of producing and using plants in agriculture for food, fuel, fiber, and land restoration. It is both a humanitarian career and a scientific one.

7) Answer: C

$$[8 \times 8 \times (8 + 1)] = 576$$

$$[13 \times 13 \times (13 + 1)] = 2366$$

8) Answer: C

Grape is a fruit.

Turmeric is a spice.

9) Answer: D

$$4 \times [4 \times (4 + 1)] = 80$$

$$9 \times [9 \times (9 + 1)] = 810$$

10) Answer: A

Small is a kind of size.

Triangle is a kind of shape.

11) Answer: B

$$(14 - 2)^2 = 144$$

$$(19 - 2)^2 = 289$$

12) Answer: A

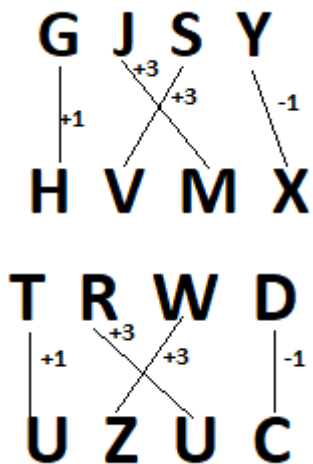

13) Answer: C

$$(25 - 1)^2 = 576$$

$$(14 - 1)^2 = 169$$

14) Answer: B

A **cataract** is a clouding of the lens of the eye which leads to a decrease in vision.

**Eczema** is a condition where patches of skin become inflamed, itchy, red, cracked, and rough.

15) Answer: D

**Puducherry** formerly known as Pondicherry is one of the 8 union territories of India.

Karnataka is a state in southwest India.

16) Answer: D

$$11^2 + 11^3 = 1452$$

$$10^2 + 10^3 = 1100$$

17) Answer: B

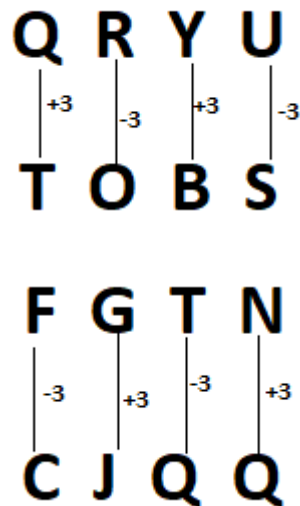

18) Answer: B

Mobile is a device that is used for telecommunication.

Train is used for transportation.

19) Answer: A

$A + 2 = C$ ;  $S + 3 = V$ ;  $K + 4 = O$ ;  $L + 5 = Q$ ;  $J + 6 = P$

Similarly,

$W + 2 = Y$ ;  $O + 3 = R$ ;  $I + 4 = M$ ;  $D + 5 = I$ ;  $N + 6 = T$

20) Answer: B

Snake is a reptile.

Toad is an amphibian.

21) Answer: D

The pinna is the only visible part of the ears.

The cornea is our eye's clear, protective outer layer.

22) Answer: C

$[9 \times (9 - 1) \times (9 - 2)] = 504$

$[11 \times (11 - 1) \times (11 - 2)] = 990$

23) Answer: C

Pencil is stationery thing.

Spoon is a utensil.

24) Answer: A

Letters are replaced by their reverse letters.

25) Answer: D

<b>D</b>	<b>O</b>	<b>C</b>	<b>T</b>	<b>O</b>	<b>R</b>
-3	-3	-3	-3	-3	-3
<b>A</b>	<b>L</b>	<b>Z</b>	<b>Q</b>	<b>L</b>	<b>O</b>

<b>K</b>	<b>R</b>	<b>O</b>	<b>P</b>	<b>B</b>
+3	+3	+3	+3	+3
<b>N</b>	<b>U</b>	<b>R</b>	<b>S</b>	<b>E</b>

26) Answer: B

$M + 4 = Q$ ;  $A + 4 = E$ ;  $N + 4 = R$

Similarly,

$G + 4 = K$ ;  $U + 4 = Y$ ;  $N + 4 = R$

27) Answer: A

'Nymph' is the young one of a 'Cockroach'.

'Lamb' is the young one of a 'Sheep'.

28) Answer: C

Dawn and Dusk are antonyms of each other.

Night and Day are antonyms of each other.

29) Answer: C

$14 \times 8 = 112$ ;  $14 \times 9 = 126$

$15 \times 8 = 120$ ;  $15 \times 9 = 135$

30) Answer: B

<b>S</b>	<b>A</b>	<b>U</b>	<b>C</b>	<b>E</b>
		+3		
<b>A</b>	<b>S</b>	<b>X</b>	<b>E</b>	<b>C</b>

<b>L</b>	<b>E</b>	<b>M</b>	<b>O</b>	<b>N</b>
		+3		
<b>E</b>	<b>L</b>	<b>P</b>	<b>N</b>	<b>O</b>

31) Answer: B

Nirmala Sitharaman is an Indian politician serving as the current Minister of Finance and Corporate Affairs of India.

Subrahmanyam Jaishankar is an Indian diplomat and politician who is the current Minister of External Affairs of the Government of India since 31 May 2019.

32) Answer: A

$$13^3 - 1 = 2196$$

$$9^3 - 1 = 728$$

33) Answer: C

A S S U M E  
+1 +1 +1 +1 +1 +1  
T B V T F N

L O C U S T  
+1 +1 +1 +1 +1 +1  
P M V D U T

34) Answer: D

Skeleton is made up of bones.

House is made up of bricks.

35) Answer: B

Lizard is a reptile.

Bat is a mammal.

36) Answer: B

$$7^2 + 3 = 52$$

$$9^2 + 3 = 84$$

37) Answer: B

The Newton (N) is the SI unit of force.

The unit of pressure in the SI system is the pascal (Pa).

38) Answer: C

Letters are replaced by their reverse letter.

39) Answer: A

G D P  
+2 +2 +2  
I F R

M A N  
+2 +2 +2  
O C P

40) Answer: C

$$11^2 \times 2 = 242$$

$$8^2 \times 2 = 128$$

41) Answer: D

A chisel is a tool used for cutting a hard material such as wood, stone, or metal used by sculptors.

A scalpel is an instrument used by a surgeon for surgery.

42) Answer: A

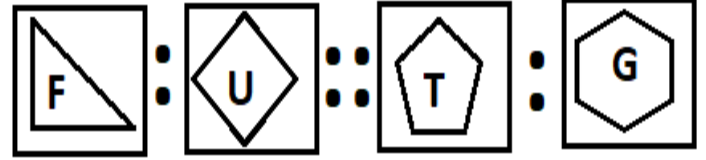

43) Answer: B

$$5^3 : (5 + 2)^3$$

$$9^3 : (9 + 2)^3$$

$$\Rightarrow 11^3 = 1331$$

44) Answer: D

Winter is a season.

Tuesday is a day of a week.

45) Answer: C

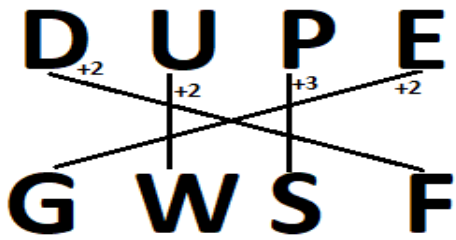
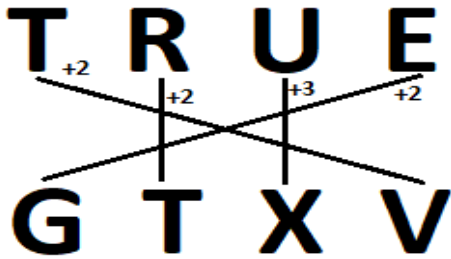

46) Answer: D

47) Answer: A

The unit to measure temperature is Fahrenheit.

The unit to measure time is seconds.

48) Answer: C

$$25 : (25 \times 4) + (25 \div 5)$$

$$55 : (55 \times 4) + (55 \div 5)$$

$$(55 \times 4) + (55 \div 5) = 220 + 11 = 231$$

49) Answer: B

Adequate : Enough – Synonyms

Cuffs : Bonds - Synonyms

50) Answer: D

Rough is antonym of smooth.

Attenuate is antonym of strong.

# ANALOGY

## TYPE-I

**Directions :** In each of the following questions, select the related word from the given alternatives.

1. Touch : Feel :: Greet : ?  
(1) Smile (2) Acknowledge  
(3) Success (4) Manners  
(SSC Combined Graduate Level Prelim Exam. 04.07.1999 (1st Sitting))
2. House : Room :: World : ?  
(1) Land (2) Sun  
(3) Air (4) Nation  
(SSC Combined Graduate Level Prelim Exam. 04.07.1999 (IInd Sitting))
3. Carbon : Diamond :: Corundum : ?  
(1) Garnet (2) Ruby  
(3) Pukhraj (4) Pearl  
(SSC Combined Graduate Level Prelim Exam. 27.02.2000 (1st Sitting))
4. Smoke : Pollution :: War : ?  
(1) Victory (2) Peace  
(3) Treaty (4) Destruction  
(SSC Combined Graduate Level Prelim Exam. 27.02.2000 (1st Sitting))
5. Ink : Pen :: Blood : ?  
(1) Accident (2) Doctor  
(3) Vein (4) Donation  
(SSC Combined Graduate Level Prelim Exam. 27.02.2000 (1st Sitting))
6. Good : Bad :: Roof : ?  
(1) Walls (2) Pillars  
(3) Floor (4) Window  
(SSC Combined Graduate Level Prelim Exam. 27.02.2000 (IInd Sitting))
7. Lion : Den :: Rabbit : ?  
(1) Hole (2) Pit  
(3) Burrow (4) Trench  
(SSC Combined Graduate Level Prelim Exam. 27.02.2000 (IInd Sitting))
8. Novelty : Oldness :: Newness : ?  
(1) Model (2) Antiquity  
(3) Discovery (4) Culture  
(SSC Combined Graduate Level Prelim Exam. 27.02.2000 (IInd Sitting))
9. Detective : Informer :: Reporter : ?  
(1) Source (2) Editorial  
(3) News (4) Essay  
(SSC Combined Graduate Level Prelim Exam. 24.02.2002 (1st Sitting))

10. Genuine : Authentic :: Mirage : ?  
(1) Illusion (2) Image  
(3) Hideout (4) Reflection  
(SSC Combined Graduate Level Prelim Exam. 24.02.2002 (1st Sitting))
11. Thunder : Rain :: ? : Night  
(1) Day (2) Dusk  
(3) Dark (4) Evening  
(SSC Combined Graduate Level Prelim Exam. 24.02.2002 (1st Sitting))
12. Botany : Plants :: Entomology : ?  
(1) Birds (2) Plants  
(3) Insects (4) Snakes  
(SSC Combined Graduate Level Prelim Exam. 24.02.2002 (IInd Sitting))
13. Parliament : Great Britain : Congress : ?  
(1) Japan (2) India  
(3) USA (4) Netherlands  
(SSC Combined Graduate Level Prelim Exam. 24.02.2002 (IInd Sitting))
14. Flow : River :: Stagnant : ?  
(1) Pool (2) Rain  
(3) Stream (4) Canal  
(SSC Combined Graduate Level Prelim Exam. 24.02.2002 (IInd Sitting))
15. Psychology : Mind :: Ornithology : ?  
(1) Sanskrit (2) Coin  
(3) Mammal (4) Bird  
(SSC Combined Graduate Level Prelim Exam. 24.02.2002 (Middle Zone))
16. Suggestion : Demand :: Take : ?  
(1) Give (2) Snatch  
(3) Gain (4) Gift  
(SSC Combined Graduate Level Prelim Exam. 24.02.2002 (Middle Zone))
17. Maximum : Excess :: Sly : ?  
(1) Pleasant  
(2) Conservative  
(3) Haphazard  
(4) Permanent  
(SSC Combined Graduate Level Prelim Exam. 24.02.2002 (Middle Zone))
18. Mother : Child :: Cloud : ?  
(1) Shine (2) Water  
(3) Rain (4) Weather  
(SSC CPO Sub-Inspector Exam. 12.01.2003)

19. Mountain : Hill :: Tree : ?  
(1) Forest (2) Shrub  
(3) Leaf (4) Ground  
(SSC CPO Sub-Inspector Exam. 12.01.2003)
20. Book : Publisher :: Film : ?  
(1) Writer (2) Editor  
(3) Director (4) Producer  
(SSC Combined Graduate Level Prelim Exam. 11.05.2003 (1st Sitting))
21. Menu : Food :: Catalogue : ?  
(1) Books (2) Library  
(3) Newspaper (4) Rack  
(SSC Combined Graduate Level Prelim Exam. 11.05.2003 (1st Sitting))
22. Framework : House :: Skeleton : ?  
(1) Ribs (2) Skull  
(3) Body (4) Grace  
(SSC Combined Graduate Level Prelim Exam. 11.05.2003 (IInd Sitting))
23. January : November :: Sunday : ?  
(1) Tuesday (2) Monday  
(3) Friday (4) Saturday  
(SSC Combined Graduate Level Prelim Exam. 11.05.2003 (IInd Sitting))
24. Taste : Tongue :: Walk : ?  
(1) Pavement  
(2) Crutch  
(3) Legs  
(4) Walking stick  
(SSC CPO Sub-Inspector Exam. 07.09.2003)
25. Chimney : Smoke :: \_\_\_ : \_\_\_  
(1) Gun : Bullet  
(2) House : Roof  
(3) Clay : Ceramic  
(4) Tea : Kettle  
(SSC CPO Sub-Inspector Exam. 07.09.2003)
26. Camera : Lens :: Flash : ?  
(1) Bulb (2) Night  
(3) Light (4) Shutter  
(SSC Combined Graduate Level Prelim Exam. 08.02.2004 (1st Sitting))
27. House : Rent :: Capital : ?  
(1) Interest (2) Investment  
(3) Country (4) Money  
(SSC Combined Graduate Level Prelim Exam. 08.02.2004 (1st Sitting))

**ANALOGY OR SIMILARITY**

- 28. Architect : Building :: Sculptor : ?**  
 (1) Museum (2) Stone  
 (3) Chisel (4) Statue  
 (SSC Combined Graduate Level Prelim Exam. 08.02.2004 (IInd Sitting))
- 29. Ice : Coldness :: Earth : ?**  
 (1) Weight (2) Gravitation  
 (3) Jungle (4) Sea  
 (SSC Combined Graduate Level Prelim Exam. 08.02.2004 (IInd Sitting))
- 30. Anaemia : Blood :: Anarchy : ?**  
 (1) Disorder  
 (2) Monarchy  
 (3) Government  
 (4) Lawlessness  
 (SSC CPO Sub-Inspector Exam. 05.09.2004)
- 31. Editor : Newspaper :: \_\_\_\_\_ : \_\_\_\_\_**  
 (1) Table : Carpenter  
 (2) Journal : Journalist  
 (3) Author : Novel  
 (4) Blacksmith : Furnace  
 (SSC CPO Sub-Inspector Exam. 05.09.2004)
- 32. Hour : Second :: Tertiary : ?**  
 (1) Ordinary (2) Secondary  
 (3) Primary (4) Intermediary  
 (SSC CPO Sub-Inspector Exam. 26.05.2005)
- 33. Poles : Magnet :: \_\_\_ Battery**  
 (1) Cells (2) Power  
 (3) Terminals (4) Energy  
 (SSC Statistical Investigators Grade-IV Exam. 31.07.2005)
- 34. Peace : Chaos :: Creation : ?**  
 (1) Build (2) Construction  
 (3) Destruction (4) Manufacture  
 (SSC Statistical Investigators Grade-IV Exam. 31.07.2005)
- 35. Safe : Secure :: Protect : ?**  
 (1) guard (2) lock  
 (3) sure (4) conserve  
 (SSC Combined Graduate Level Prelim Exam. 13.11.2005 (Ist Sitting))
- 36. Physician : Treatment :: Judge : ?**  
 (1) Punishment (2) Judgement  
 (3) Lawyer (4) Court  
 (SSC Combined Graduate Level Prelim Exam. 13.11.2005 (Ist Sitting))
- 37. Doctor : Stethoscope :: Sculptor : ?**  
 (1) Anvil (2) Chopper  
 (3) Chisel (4) Trowel  
 (SSC Combined Graduate Level Prelim Exam. 13.11.2005 (IInd Sitting))
- 38. Study : Knowledge :: Work : ?**  
 (1) Experiment (2) Service  
 (3) Experience (4) Appointment  
 (SSC Combined Graduate Level Prelim Exam. 13.11.2005 (IInd Sitting))
- 39. Paddy : Field :: Steel : ?**  
 (1) Iron (2) Factory  
 (3) Ore (4) Mine  
 (SSC Statistical Investigators Grade-IV Exam. 13.08.2006)
- 40. Laugh : Joke :: ? : Cracker**  
 (1) Fear (2) Anger  
 (3) Fireball (4) Explode  
 (SSC Statistical Investigators Grade-IV Exam. 13.08.2006)
- 41. President : India :: King : ?**  
 (1) England (2) China  
 (3) Jordan (4) France  
 (SSC Statistical Investigators Grade-IV Exam. 13.08.2006)
- 42. Light : Rays :: Sound : ?**  
 (1) Audio (2) Wave  
 (3) Hear (4) Visual  
 (SSC Statistical Investigators Grade-IV Exam. 13.08.2006)
- 43. West : North - East :: South?**  
 (1) North-West (2) South East  
 (3) North (4) East  
 (SSC CPO Sub-Inspector Exam. 03.09.2006)
- 44. Oasis : Desert :: ? : Sea**  
 (1) Island (2) Peninsula  
 (3) Backwaters (4) Cliff  
 (SSC CPO Sub-Inspector Exam. 03.09.2006)
- 45. Pound : Yen :: Polo : ?**  
 (1) Hockey (2) Horse  
 (3) Ride (4) Stick  
 (SSC Combined Graduate Level Prelim Exam. 04.02.2007 (Ist Sitting))
- 46. Quack : Duck : Neigh : ?**  
 (1) Fox (2) Horse  
 (3) Frog (4) Cat  
 (SSC Combined Graduate Level Prelim Exam. 04.02.2007 (Ist Sitting))
- 47. Dream : Reality :: Falsehood : ?**  
 (1) Untruth (2) Truth  
 (3) Fairness (4) Correctness  
 (SSC Combined Graduate Level Prelim Exam. 04.02.2007 (Ist Sitting))
- 48. Soldier : Regiment :: Horse : ?**  
 (1) Navy (2) Fleet  
 (3) Cavalry (4) Herd  
 (SSC Combined Graduate Level Prelim Exam. 04.02.2007 (IInd Sitting))
- 49. Philatelist : Stamps :: Numismatist : ?**  
 (1) Coins (2) Maps  
 (3) Jewels (4) Samples  
 (SSC Combined Graduate Level Prelim Exam. 04.02.2007 (IInd Sitting))
- 50. PHOTO : FILM :: PHOTOSTAT : ?**  
 (1) Photographic paper  
 (2) Voltage controller  
 (3) Electricity  
 (4) Paper  
 (SSC Combined Graduate Level Prelim Exam. 04.02.2007 (IInd Sitting))
- 51. Sorrow : Joy :: Pleasure : ?**  
 (1) Anger (2) Pain  
 (3) Jealousy (4) Malice  
 (SSC CPO Sub-Inspector Exam. 16.12.2007)
- 52. Surgeon : Forceps :: ?**  
 (1) Doctor : Prescription  
 (2) Refugee : Asylum  
 (3) Blacksmith : Hammer  
 (4) Driver : Brake oil  
 (SSC CPO Sub-Inspector Exam. 16.12.2007)
- 53. Thread : Cloth :: Wire : ?**  
 (1) Rope (2) Mesh  
 (3) Sieve (4) Telegraph  
 (SSC Combined Graduate Level Prelim Exam. 27.07.2008 (IInd Sitting))
- 54. Scissors : Cloth :: ?**  
 (1) Stone : Grinder  
 (2) Axe : Wood  
 (3) Knife : Stone  
 (4) Gun : Hunt  
 (SSC Combined Graduate Level Prelim Exam. 27.07.2008 (IInd Sitting))
- 55. Yesterday : Tomorrow :: March : ?**  
 (1) April (2) May  
 (3) January (4) June  
 (SSC CPO Sub-Inspector Exam. 09.11.2008)
- 56. bifurcate : divide : loathe : ?**  
 (1) love (2) jealous  
 (3) detest (4) rude  
 (SSC CPO Sub-Inspector Exam. 09.11.2008)

**ANALOGY OR SIMILARITY**

- 57. River : Dam :: Traffic : ?**  
 (1) Vehicle (2) Speed  
 (3) Signal light (4) Path  
 (SSC CPO Sub-Inspector Exam. 06.09.2009)
- 58. Ornithologist : Birds :: Archaeologist : ?**  
 (1) Artifacts (2) Archipelago  
 (3) Arbiter (4) Aquatic  
 (SSC CPO Sub-Inspector Exam. 06.09.2009)
- 59. Fox : Cunning :: Rabbit : ?**  
 (1) Courageous (2) Dangerous  
 (3) Timid (4) Ferocious  
 (SSC Combined Graduate Level Tier-1 Exam.16.05.2010 (IInd Sitting))
- 60. Flexible : Rigid :: Confidence : ?**  
 (1) Diffidence (2) Indifference  
 (3) Cowardice (4) Scare  
 (SSC Combined Graduate Level Tier-1 Exam.16.05.2010 (IInd Sitting))
- 61. SORROW : CRY :: MIRTH : ?**  
 (1) JOY (2) LAUGHTER  
 (3) FROWN (4) WEEP  
 (SSC SAS Exam. 26.06.2010 (Paper-I))
- 62. Love : Hate :: Proud : ?**  
 (1) Sorrowful (2) Miserable  
 (3) Humble (4) Conceited  
 (SSC SAS Exam. 26.06.2010 (Paper-I))
- 63. Light : Darkness :: Knowledge : ?**  
 (1) Ignorance (2) Intelligence  
 (3) Brightness (4) Greative  
 (SSC CISF ASI Exam. 29.08.2010 (Paper-I))
- 64. Scissors : Cloth :: ?**  
 (1) Pen : Ink  
 (2) Razor : Beard  
 (3) Furnace : Smoke  
 (4) Nail : Hammer  
 (SSC CISF ASI Exam. 29.08.2010 (Paper-I))
- 65. Stethoscope : Heartbeat :: ? : Temperature**  
 (1) Heat (2) Mercury  
 (3) Scale (4) Thermometer  
 (SSC CPO Sub-Inspector Exam.12.12.2010 (Paper-I))
- 66. Spring : Summer ::**  
 (1) Sunday : Monday  
 (2) Thursday : Wednesday  
 (3) Tuesday : Friday  
 (4) Friday : Monday  
 (SSC CPO Sub-Inspector Exam.12.12.2010 (Paper-I))
- 67. Timid : Ass :: Cunning : ?**  
 (1) Ant (2) Fox  
 (3) Rabbit (4) Horse  
 (SSC Combined Graduate Level Prelim Exam.19.06.2011 (1st Sitting))
- 68. Ecstasy : Gloom :: ?**  
 (1) Congratulations : Occasion  
 (2) Diligent : Successful  
 (3) Measure : Scale  
 (4) Humiliation : Exaltation  
 (SSC Combined Graduate Level Prelim Exam.19.06.2011 (1st Sitting))
- 69. Country : President :: State : ?**  
 (1) Chief Minister  
 (2) Prime Minister  
 (3) Speaker  
 (4) Governor  
 (SSC Combined Graduate Level Prelim Exam. 19.06.2011 (IInd Sitting))
- 70. Mirage : Desert :: ?**  
 (1) Sky : Illusion  
 (2) Rainbow : Sky  
 (3) Rain : Rainbow  
 (4) Image : Mirror  
 (SSC Combined Graduate Level Prelim Exam. 19.06.2011 (IInd Sitting))
- 71. Fish : Scales :: Bear : ?**  
 (1) Feathers (2) Leaves  
 (3) Fur (4) Skin  
 (SSC Combined Graduate Level Tier-1 Exam. 26.06.2011 (1st Sitting))
- 72. Writer : Pen :: ?**  
 (1) Needle : Tailor  
 (2) Artist : Brush  
 (3) Painter : Canvas  
 (4) Teacher : Class  
 (SSC Combined Graduate Level Tier-1 Exam. 26.06.2011 (1st Sitting))
- 73. Procession : Route :: Earth : ?**  
 (1) Space (2) Sun  
 (3) Orbit (4) Highway  
 (SSC Combined Graduate Level Tier-1 Exam. 26.06.2011 (IInd Sitting))
- 74. FERTILIZER : CROPS :: ?**  
 (1) TEACHER : EDUCATION  
 (2) CHLORINE : WATER  
 (3) TONIC : BODY  
 (4) PESTICIDE : RATS  
 (SSC Combined Graduate Level Tier-1 Exam. 26.06.2011 (IInd Sitting))
- 75. Gravity : Pull :: Magnetism : ?**  
 (1) Earth (2) Gold  
 (3) Attract (4) Weight  
 (SSC Combined Matric Level (PRE) Exam.24.10.1999 (1st Sitting))
- 76. ? : Knee :: Wrist : Elbow**  
 (1) Hand (2) Leg  
 (3) Ankle (4) Fingers  
 (SSC Combined Matric Level (PRE) Exam.24.10.1999 (1st Sitting))
- 77. Face : Expression :: Music : ?**  
 (1) Sound (2) Ear  
 (3) Tune (4) Instrument  
 (SSC Combined Matric Level (PRE) Exam.24.10.1999 (1st Sitting))
- 78. Day : Night :: Dusk : ?**  
 (1) Morning (2) Noon  
 (3) Evening (4) Dawn  
 (SSC Combined Matric Level (PRE) Exam.24.10.1999 (1st Sitting))
- 79. Television : Telecast :: Radio : ?**  
 (1) Broadcast (2) News  
 (3) Music (4) Dawn  
 (SSC Combined Matric Level (PRE) Exam.24.10.1999 (1st Sitting))
- 80. Motor Car : Garage :: Aeroplane : ?**  
 (1) Air Field (2) Hanger  
 (3) Air Port (4) Runway  
 (SSC Combined Matric Level (PRE) Exam.24.10.1999 (IInd Sitting))
- 81. Bird : Fish :: Aeroplane : ?**  
 (1) Air (2) Car  
 (3) Water (4) Ship  
 (SSC Combined Matric Level (PRE) Exam.24.10.1999 (IInd Sitting))
- 82. Thread : Cloth :: Wire : ?**  
 (1) Rope (2) Mesh  
 (3) Sieve (4) Telegraph  
 (SSC Combined Matric Level (PRE) Exam.24.10.1999 (IInd Sitting))
- 83. Spacious : Capacity :: Scanty : ?**  
 (1) Possibility (2) Density  
 (3) Scarcity (4) Fancy  
 (SSC Combined Matric Level (PRE) Exam.24.10.1999 (IInd Sitting))
- 84. Thermometer : Temperature :: Hygrometer : ?**  
 (1) Pressure (2) Density  
 (3) Stress (4) Humidity  
 (SSC Combined Matric Level (PRE) Exam.24.10.1999 (IInd Sitting))
- 85. Lock : Key :: Crime : ?**  
 (1) Investigation (2) Mystery  
 (3) Criminal (4) Conviction  
 (SSC Combined Matric Level (PRE) Exam. 21.05.2000 (1st Sitting (East Zone))
- 86. Radio : Listener :: Film : ?**  
 (1) Transmission (2) Criticism  
 (3) Hero (4) Audience  
 (SSC Combined Matric Level (PRE) Exam. 21.05.2000 (1st Sitting (East Zone))
- 87. Book : Library :: Animal : ?**  
 (1) Domestic (2) Hunter  
 (3) Wild (4) Zoo  
 (SSC Combined Matric Level (PRE) Exam. 21.05.2000 (1st Sitting (East Zone))

**ANALOGY OR SIMILARITY**

- 88. Health : Sickness :: Happiness : ?**  
 (1) Medicine (2) Treatment  
 (3) Misery (4) Cheerfulness  
 (SSC Combined Matric Level (PRE)  
 Exam. 21.05.2000 (Ist Sitting (East Zone)
- 89. Air : Breach :: Blood : ?**  
 (1) Circulation (2) Red  
 (3) Thick (4) Shed  
 (SSC Combined Matric Level (PRE)  
 Exam.21.05.2000 (Ist Sitting)  
 (Raipur, Madhya Pradesh)
- 90. Mathematics : Logic :: Science : ?**  
 (1) Experiment (2) Laboratory  
 (3) Scientist (4) Facts  
 (SSC Combined Matric Level (PRE)  
 Exam.21.05.2000 (Ist Sitting)  
 (Raipur, Madhya Pradesh)
- 91. Magazine : Editor :: Drama : ?**  
 (1) Principal (2) Actress  
 (3) Scenario (4) Director  
 (SSC Combined Matric Level (PRE)  
 Exam.21.05.2000 (Ist Sitting)  
 (Raipur, Madhya Pradesh)
- 92. Foot : Man :: Hoof : ?**  
 (1) Dog (2) Cow  
 (3) Cat (4) Rabbit  
 (SSC Combined Matric Level (PRE)  
 Exam.21.05.2000 (Ist Sitting)  
 (Raipur, Madhya Pradesh)
- 93. Drop : Ocean :: Star : ?**  
 (1) Sky (2) Shine  
 (3) Twinkle (4) Bright  
 (SSC Combined Matric Level (PRE)  
 Exam. 21.05.2000 (Ist Sitting)  
 (Middle Zone)
- 94. Hospital : Doctor :: Temple : ?**  
 (1) Magistrate (2) Manager  
 (3) Priest (4) Temple Artist  
 (SSC Combined Matric Level (PRE)  
 Exam. 21.05.2000 (Ist Sitting)  
 (Middle Zone)
- 95. Author : Novel :: Designer : ?**  
 (1) Cloth (2) Dress  
 (3) Suit (4) Textile  
 (SSC Combined Matric Level (PRE)  
 Exam. 21.05.2000 (Ist Sitting)  
 (Middle Zone)
- 96. Tailor : Cloth :: Farmer : ?**  
 (1) Crop (2) Plough  
 (4) Spade (4) Land  
 (SSC Combined Matric Level (PRE)  
 Exam. 21.05.2000 (Ist Sitting)  
 (Middle Zone)
- 97. Stomach : Food :: Engine : ?**  
 (1) Fuel (2) Plane  
 (3) Car (4) Machine  
 (SSC Combined Matric Level (PRE)  
 Exam. 21.05.2000 (IInd Sitting)  
 (Middle Zone, Allahabad)

- 98. Bullet : Gun :: Smoke : ?**  
 (1) Fire (2) Cigarette  
 (3) Factory (4) Chimney  
 (SSC Combined Matric Level (PRE)  
 Exam. 21.05.2000 (IInd Sitting)  
 (Middle Zone, Allahabad)
- 99. Quack : Duck :: Bellow : ?**  
 (1) Fox (2) Bull  
 (3) Frog (4) Cat  
 (SSC Combined Matric Level (PRE)  
 Exam. 21.05.2000 (IInd Sitting)  
 (Middle Zone, Allahabad)
- 100. Elbow : Wrist :: Knee : ?**  
 (1) Fingers (2) Feet  
 (3) Ankle (4) Thigh  
 (SSC Combined Matric Level (PRE)  
 Exam. 21.05.2000 (IInd Sitting)  
 (Middle Zone, Allahabad)
- 101. Scribble : Write :: Stammer : ?**  
 (1) Walk (2) Play  
 (3) Speak (4) Dance  
 (SSC Combined Matric Level (PRE)  
 Exam.13.05.2001 (Ist Sitting)
- 102. MINE : I :: ?**  
 (1) OURS and US  
 (2) SHE and HERS  
 (3) HIS and HE  
 (4) THEIRS and THEM  
 (SSC Combined Matric Level (PRE)  
 Exam.13.05.2001 (Ist Sitting)
- 103. Cat is to Feline as Horse is to**  
 (1) Equine (2) Tiger  
 (3) Vulpine (4) Quadruped  
 (SSC Combined Matric Level (PRE)  
 Exam.13.05.2001 (Ist Sitting)
- 104. Fish : Gills :: Man : ?**  
 (1) Ear (2) Eyey  
 (3) Lung (4) Nose  
 (SSC Combined Matric Level (PRE)  
 Exam.13.05.2001 (Ist Sitting)
- 105. Brush : Paint :: Shovel : ?**  
 (1) Oil (2) Water  
 (3) Coal (4) Brick  
 (SSC Combined Matric Level (PRE)  
 Exam.13.05.2001 (Ist Sitting)
- 106. Rough : Smooth :: Systematic : ?**  
 (1) Sloppy (2) Carefree  
 (3) Meticulous (4) Cautious  
 (SSC Combined Matric Level (PRE)  
 Exam.13.05.2001 (Ist Sitting)
- 107. Thermometer : Temperature ::**  
 Barometer : ?  
 (1) Heat (2) Weight  
 (3) Volume (4) Pressure  
 (SSC Combined Matric Level (PRE)  
 Exam.13.05.2001 (IInd Sitting)

- 108. Create : Destroy :: Condense : ?**  
 (1) Retreat (2) Expand  
 (3) Gradual (4) Initial  
 (SSC Combined Matric Level (PRE)  
 Exam.13.05.2001 (IInd Sitting)
- 109. Cinema : Audience :: Church : ?**  
 (1) Prayer (2) Meditation  
 (3) Loneliness (4) Congregation  
 (SSC Combined Matric Level (PRE)  
 Exam.13.05.2001 (IInd Sitting)
- 110. Action : Reaction :: ?**  
 (1) Stimulus : Response  
 (2) Book : Cover  
 (3) Firing : Running  
 (4) Birth : Death  
 (SSC Combined Matric Level (PRE)  
 Exam.13.05.2001 (IInd Sitting)
- 111. Meat : Vegetarian :: Liquor : ?**  
 (1) Insane (2) Teetotaller  
 (3) Introvert (4) Alcoholic  
 (SSC Combined Matric Level (PRE)  
 Exam.13.05.2001 (IInd Sitting)
- 112. Monday : Moon :: Tuesday : ?**  
 (1) Mercury (2) Mars  
 (3) Pluto (4) Jupiter  
 (SSC Combined Matric Level (PRE)  
 Exam.13.05.2001 (IInd Sitting)
- 113. Stable : Horse :: Sty : ?**  
 (1) Cow (2) Buffalo  
 (3) Pig (4) Fly  
 (SSC Combined Matric Level (PRE)  
 Exam.13.05.2001 (IInd Sitting)
- 114. Part : Whole :: Arc : ?**  
 (1) Triangle (2) Square  
 (3) Circle (4) Trapezium  
 (SSC Combined Matric Level (PRE)  
 Exam. 27.05.2001 (IInd Sitting)  
 (East Zone)
- 115. Immigration : Arrival :: Emigra-  
 tion : ?**  
 (1) Leaving (2) Alien  
 (3) Native (4) Emigrant  
 (SSC Combined Matric Level (PRE)  
 Exam. 27.05.2001 (IInd Sitting)  
 (East Zone)
- 116. Blind : Visual :: Deaf : ?**  
 (1) Hearing (2) Listening  
 (3) Auditory (4) Sound  
 (SSC Combined Matric Level (PRE)  
 Exam. 27.05.2001 (IInd Sitting)  
 (East Zone)
- 117. Monotony : Variety :: Crude-  
 ness : ?**  
 (1) Sobriety (2) Simplicity  
 (3) Raw (4) Refinement  
 (SSC Combined Matric Level (PRE)  
 Exam. 27.05.2001 (IInd Sitting)  
 (East Zone)

**ANALOGY OR SIMILARITY**

- 118. Pulp : Paper :: Hemp : ?**  
 (1) Rope (2) Cotton  
 (3) Yarn (4) Baskets  
 (SSC Combined Matric Level (PRE)  
 Exam. 27.05.2001 (IInd Sitting  
 (East Zone)
- 119. Injury : Pain :: ?**  
 (1) Grades : Merit  
 (2) Thunder : Lightning  
 (3) Rotate : Churning  
 (4) Matter : Labour  
 (SSC Combined Matric Level (PRE)  
 Exam. 27.05.2001 (IInd Sitting  
 (East Zone)
- 120. Book : Critic :: Building : ?**  
 (1) Appraiser (2) Weigher  
 (3) Contractor (4) Engineer  
 (SSC Combined Matric Level (PRE)  
 Exam. 27.05.2001 (IInd Sitting  
 (East Zone)
- 121. Microphone : Loud :: Micro-  
 scope : ?**  
 (1) Elongate (2) Investigate  
 (3) Examine (4) Magnify  
 (SSC Combined Matric Level (PRE)  
 Exam. 05.05.2002 (Ist Sitting)  
 (Eastern Zone, Guwahati)
- 122. Cup : Lip :: Bird : ?**  
 (1) Forest (2) Bush  
 (3) Wood (4) Grass  
 (SSC Combined Matric Level (PRE)  
 Exam. 05.05.2002 (Ist Sitting)  
 (Eastern Zone, Guwahati)
- 123. Glove : Hand :: ? : ?**  
 (1) Neck : Collar (2) Tie : Shirt  
 (3) Socks : Feet (4) Coat : Pocket  
 (SSC Combined Matric Level (PRE)  
 Exam. 05.05.2002 (Ist Sitting)  
 (Eastern Zone, Guwahati)
- 124. Rain : Umbrella :: Flood : ?**  
 (1) Bridge (2) Electricity  
 (3) Dam (4) Water  
 (SSC Combined Matric Level (PRE)  
 Exam. 05.05.2002 (IInd Sitting)  
 (Eastern Zone, Guwahati)
- 125. Receptionist : Office :: Hostess : ?**  
 (1) Crew (2) Host  
 (3) Airport (4) Aircraft  
 (SSC Combined Matric Level (PRE)  
 Exam. 05.05.2002 (IInd Sitting)  
 (Eastern Zone, Guwahati)
- 126. Adult : Baby :: Flower : ?**  
 (1) Seed (2) Bud  
 (3) Fruit (4) Stem  
 (SSC Combined Matric Level (PRE)  
 Exam.05.05.2002 (Ist Sitting  
 (North Zone, Delhi)

- 127. Typist : Typewriter :: Writer : ?**  
 (1) Script (2) Pen  
 (3) Paper (4) Book  
 (SSC Combined Matric Level (PRE)  
 Exam.05.05.2002 (Ist Sitting  
 (North Zone, Delhi)
- 128. Carrot : Root :: Apple : ?**  
 (1) Plant (2) Fruit  
 (3) Flower (4) Seed  
 (SSC Combined Matric Level (Pre)  
 Exam. 05.05.2002 (IInd Sitting)  
 (North Zone Delhi)
- 129. PIGEON : PEACE :: ?**  
 (1) CROWN : HEAD  
 (2) WHITE FLAG : SURRENDER  
 (3) LAURELS : VICTORY  
 (4) WAR : LIBERTY  
 (SSC Combined Matric Level (Pre)  
 Exam. 05.05.2002 (IInd Sitting)  
 (North Zone Delhi)
- 130. Sculptor : Chisel :: Author : ?**  
 (1) Table (2) Paper  
 (3) Book (4) Pen  
 (SSC Combined Matric Level (Pre)  
 Exam. 05.05.2002 (IInd Sitting)  
 (North Zone Delhi)
- 131. BOOK : BOOKCASE ::  
 CLOTHES : ?**  
 (1) RACK  
 (2) PRESS  
 (3) WARDROBE  
 (4) NAPHTHALENE BALLS  
 (SSC Combined Matric Level (Pre)  
 Exam. 05.05.2002 (IInd Sitting)  
 (North Zone Delhi)
- 132. Music : Notation :: Poem : ?**  
 (1) Verses (2) Stanza  
 (3) Sentences (4) Lines  
 (SSC Combined Matric Level (Pre)  
 Exam. 12.05.2002 (Ist Sitting)
- 133. Fish : Bird :: ?**  
 (1) Submarine : Aeroplane  
 (2) Master : Eagle  
 (3) Rifle : Tank  
 (4) Hydra : Ocean  
 (SSC Combined Matric Level (Pre)  
 Exam. 12.05.2002 (Ist Sitting)
- 134. Scissors : Cloth :: ?**  
 (1) Axe : Wood  
 (2) Stone : Grinder  
 (3) Knife : Stone  
 (4) Sickle : Brick  
 (SSC Combined Matric Level (Pre)  
 Exam. 12.05.2002 (Ist Sitting)
- 135. Hand : Wrist :: ?**  
 (1) Muscle : Bone  
 (2) Skull : Brain  
 (3) Ear : Hair  
 (4) Foot : Ankle  
 (SSC Combined Matric Level (Pre) Exam.  
 12.05.2002 (Ist Sitting)

- 136. Rat : Cat :: Worm : ?**  
 (1) Silk (2) Bird  
 (3) Earth (4) Fishing  
 (SSC Combined Matric Level (Pre)  
 Exam. 12.05.2002 (IInd Sitting)
- 137. Goldsmith : Gold :: ?**  
 (1) Carpenter : Wood  
 (2) Cobbler : Shoes  
 (3) Jeweller : Jewellery  
 (4) Barber : Shave  
 (SSC Combined Matric Level (Pre)  
 Exam. 12.05.2002 (IInd Sitting)
- 138. Druggist : Pharmacy :: ?**  
 (1) Chef : Restaurant  
 (2) Librarian : Catalogue  
 (3) Carpenter : Wood  
 (4) Physician : Patient  
 (SSC Combined Matric Level (Pre)  
 Exam. 12.05.2002 (IInd Sitting)
- 139. Car : Garage :: Aeroplane : ?**  
 (1) Airhostess (2) Flying  
 (3) Hangar (4) Landing  
 (SSC Combined Matric Level (Pre)  
 Exam.16.06.2002 (Re-Exam)
- 140. Cruel : Kind :: Humility : ?**  
 (1) Arrogance (2) Self - effacing  
 (3) Simple (4) Weakness  
 (SSC Combined Matric Level (Pre)  
 Exam.16.06.2002 (Re-Exam)
- 141. Gold : Goldsmith :: Leather : ?**  
 (1) Tanner (2) Dyer  
 (3) Cobbler (4) Butcher  
 (SSC Combined Matric Level (Pre)  
 Exam.16.06.2002 (Re-Exam)
- 142. Insect : Bee :: Mammal : ?**  
 (1) Man (2) Fish  
 (3) Bird (4) Snake  
 (SSC Combined Matric Level (Pre)  
 Exam.16.06.2002 (Re-Exam)
- 143. Calendar : Date :: ? : ?**  
 (1) Time : Hour  
 (2) Transport : Bus  
 (3) Dictionary : Word  
 (4) City : Pin Code  
 (SSC Combined Matric Level (Pre)  
 Exam.30.07.2006 (Ist Sitting)(East Zone)
- 144. Editor : Magazine**  
 (1) Movie : Scene  
 (2) Music : Actor  
 (3) Drama : Director  
 (4) Drawing : Artist  
 (SSC Combined Matric Level (Pre)  
 Exam.30.07.2006 (IInd Sitting)  
 (Central Zone)

**ANALOGY OR SIMILARITY**

- 145.** Hinduism, Christianity, Islam : Religion  
 (1) Ear, Nose, Eyesight : Vision  
 (2) Plus, Minus, Multiple : Division  
 (3) Winter, Spring, Summer : Seasons  
 (4) Humid, Hot, Tundra : Region  
 SSC Combined Matric Level (Pre)  
 Exam. 30.07.2006 (IInd Sitting)  
 (Central Zone)
- 146.** Poet : Poem :: Dramatist : ?  
 (1) Dialogue (2) Stage  
 (3) Play (4) Direction  
 SSC Combined Matric Level (Pre)  
 Exam. 30.03.2008 (1st Sitting)
- 147.** Handsome : Beautiful :: Man : ?  
 (1) Charming (2) Man  
 (3) Woman (4) She  
 SSC Combined Matric Level (Pre)  
 Exam. 30.03.2008 (1st Sitting)
- 148.** Mechanic : Spanner :: Carpenter : ?  
 (1) Tree (2) Wood  
 (3) Furniture (4) Saw  
 SSC Data Entry Operator  
 Exam. 31.08.2008
- 149.** Grain : Warehouse :: Water : ?  
 (1) Drink (2) Dam  
 (3) Canal (4) River  
 SSC Data Entry Operator  
 Exam. 31.08.2008
- 150.** Hunger : Food :: Disease : ?  
 (1) Weakness (2) Medicine  
 (3) Sickness (4) Water  
 SSC Data Entry Operator  
 Exam. 02.08.2009
- 151.** Thin : Thick :: Dwarf : ?  
 (1) Short (2) Tall  
 (3) Broad (4) Long  
 SSC Data Entry Operator  
 Exam. 02.08.2009
- 152.** MAN : BIOGRAPHY :: NATION : ?  
 (1) PEOPLE (2) POPULATION  
 (3) GEOGRAPHY  
 (4) HISTORY  
 SSC Stenographer (Grade 'C' & 'D')  
 Exam. 26.09.2010
- 153.** Crop : Farm :: Ore : ?  
 (1) Iron (2) Volcano  
 (3) Mine (4) Factory  
 SSC Stenographer (Grade 'C' & 'D')  
 Exam. 26.09.2010
- 154.** Dog : Rabies :: Mosquito : ?  
 (1) Plague (2) Death  
 (3) Malaria (4) Sting  
 (SSC HSL DEO & LDC Exam. 27.11.2010)
- 155.** Clock : Time :: Thermometer : ?  
 (1) Heat (2) Radiation  
 (3) Energy (4) Temperature  
 (SSC Higher Secondary Level  
 Data Entry Operator & LDC  
 Exam. 27.11.2010)
- 156.** DOCTOR : PATIENT :: LAWYER : ?  
 (1) CUSTOMER (2) CLIENT  
 (3) CONSUMER (4) BUYER  
 (SSC Higher Secondary Level  
 Data Entry Operator & LDC  
 Exam. 28.11.2010 (1st sitting))
- 157.** Encouragement : Victory :: Frustration : ?  
 (1) Stalemate (2) Anger  
 (3) Failure (4) Anxiety  
 (SSC Higher Secondary Level  
 Data Entry Operator & LDC  
 Exam. 28.11.2010 (1st sitting))
- 158.** Dog : Canine :: Horse : ?  
 (1) Grass (2) Race  
 (3) Hoof (4) Transport  
 (SSC Higher Secondary Level  
 Data Entry Operator & LDC  
 Exam. 28.11.2010 (1st sitting))
- 159.** Tadpole : Frog :: Cub : ?  
 (1) Hedgehog (2) Lion  
 (3) Cat (4) Dog  
 (SSC Higher Secondary Level  
 Data Entry Operator & LDC  
 Exam. 28.11.2010 (IInd sitting))
- 160.** Brick : Mason :: Colour : ?  
 (1) Child (2) Teacher  
 (3) Painter (4) Potter  
 (SSC Higher Secondary Level  
 Data Entry Operator & LDC  
 Exam. 28.11.2010 (IInd sitting))
- 161.** Sleep : Rest :: Play : ?  
 (1) Enjoyment (2) Learning  
 (3) Injury (4) Champion  
 (SSC Higher Secondary Level  
 Data Entry Operator & LDC  
 Exam. 28.11.2010 (IInd sitting))
- 162.** Fast : Hunger :: Race : ?  
 (1) Smartness (2) Strength  
 (3) Horse (4) Fatigue  
 (SSC Stenographer Grade 'C' & 'D')  
 Exam. 09.01.2011)
- 163.** Antonym : Synonym :: Analysis : ?  
 (1) Synthesis (2) Synchronize  
 (3) Simplify (4) Summarise  
 (SSC Stenographer Grade 'C' & 'D')  
 Exam. 09.01.2011)
- 164.** Saw : Carpenter :: Scissors : ?  
 (1) Farmer (2) Tailor  
 (3) Painter (4) Artist  
 (SSC CISF Constable (GD)  
 Exam. 05.06.2011)
- 165.** Human % Child % % \\  
 (1) Lion : Cub (2) Cow : Bull  
 (3) Duck : Drake (4) Fish : Prawn  
 (SSC Stenographer (Grade 'C' & 'D')  
 Exam. 16.10.2011)
- 166.** Good conductor : Copper :: Bad conductor : ?  
 (1) Iron (2) Aluminium  
 (3) Wood (4) Coal  
 (SSC Stenographer (Grade 'C' & 'D')  
 Exam. 16.10.2011)
- 167.** Volcano : Lava :: Fire : ?  
 (1) Heat (2) Light  
 (3) Smoke (4) Ashes  
 (SSC Stenographer (Grade 'C' & 'D')  
 Exam. 16.10.2011)
- 168.** Necklace : Adornment :: ?  
 (1) Medal : Decoration  
 (2) Bronze : Medal  
 (3) Scarf : Dress  
 (4) Window : House  
 SSC (10+2) Level Data Entry  
 Operator & LDC Exam. 04.12.2011  
 (1st Sitting (North Zone))
- 169.** Black : White :: up : ?  
 (1) Opposite  
 (2) Disappointment  
 (3) Wall  
 (4) Down  
 SSC (10+2) Level Data Entry  
 Operator & LDC Exam. 04.12.2011  
 (1st Sitting (North Zone))
- 170.** Book : Author :: Statue : ?  
 (1) Mason (2) Painter  
 (3) Sculptor (4) Calligrapher  
 SSC (10+2) Level Data Entry  
 Operator & LDC Exam. 04.12.2011  
 (1st Sitting (North Zone))
- 171.** Life : Death :: Hope : ?  
 (1) Weep (2) Pain  
 (3) Despair (4) Sadness  
 SSC (10+2) Level Data Entry  
 Operator & LDC Exam. 04.12.2011 (IInd  
 Sitting (North Zone))
- 172.** Christian : Muslim :: ? : Quran  
 (1) Geeta (2) Ramayan  
 (3) Angel (4) Bible  
 SSC (10+2) Level Data Entry  
 Operator & LDC Exam. 04.12.2011 (IInd  
 Sitting (North Zone))
- 173.** Large : Enormous :: ?  
 (1) Cat : Tiger (2) Warmth : Frost  
 (3) Plump : Fat (4) Royal : Regale  
 SSC (10+2) Level Data Entry  
 Operator & LDC Exam. 04.12.2011 (IInd  
 Sitting (North Zone))

**ANALOGY OR SIMILARITY**

- 174.** Life : Death :: Beginning : ?  
 (1) Era (2) End  
 (3) Time (4) Commence  
 SSC (10+2) Level Data Entry  
 Operator & LDC Exam. 04.12.2011  
 (1st Sitting (East Zone))
- 175.** Leg : Knee :: Arm : ?  
 (1) Hand (2) Wrist  
 (3) Elbow (4) Sleeve  
 SSC (10+2) Level Data Entry  
 Operator & LDC Exam. 04.12.2011  
 (1st Sitting (East Zone))
- 176.** Interrupt : Speak :: ?  
 (1) Shout: Yell  
 (2) Intrude: Enter  
 (3) Interfere: Clash  
 (4) Telephone: Telegraph  
 SSC (10+2) Level Data Entry  
 Operator & LDC Exam. 04.12.2011  
 (1st Sitting (East Zone))
- 177.** Love: Hate :: Friend: ?  
 (1) Trustful (2) Companion  
 (3) Adorer (4) Enemy  
 SSC (10+2) Level Data Entry  
 Operator & LDC Exam. 04.12.2011  
 (1st Sitting (East Zone))
- 178.** Poverty: Unemployment :: Anaemia: ?  
 (1) Malnutrition (2) Illiteracy  
 (3) Drought (4) Death  
 SSC (10+2) Level Data Entry  
 Operator & LDC Exam. 04.12.2011  
 (1st Sitting (East Zone))
- 179.** Encourage : Restrict :: ?  
 (1) gain : success  
 (2) dearth: surplus  
 (3) seeing : believing  
 (4) heart: soul  
 SSC (10+2) Level Data Entry  
 Operator & LDC Exam. 04.12.2011  
 (1st Sitting (East Zone))
- 180.** Defy : Obey :: Rest : ?  
 (1) Lazy (2) Idle  
 (3) Labour (4) Work  
 SSC (10+2) Level Data Entry  
 Operator & LDC Exam. 11.12.2011  
 (1st Sitting (Delhi Zone))
- 181.** Water : Swim :: Land : ?  
 (1) Walk (2) Stand  
 (3) Sit (4) Move  
 SSC (10+2) Level Data Entry  
 Operator & LDC Exam. 11.12.2011  
 (1st Sitting (Delhi Zone))
- 182.** Patient : Doctor :: ?  
 (1) Student : Advisor  
 (2) Scissor : Iron  
 (3) Apple : Knife  
 (4) Nurse : Surgeon  
 SSC (10+2) Level Data Entry  
 Operator & LDC Exam. 11.12.2011  
 (1st Sitting (Delhi Zone))

- 183.** Horse : Hoof :: ?  
 (1) Man : Foot  
 (2) Dog : Black  
 (3) Paise : Rupee  
 (4) Pen : Pencil  
 SSC (10+2) Level Data Entry  
 Operator & LDC Exam. 11.12.2011  
 (1st Sitting (Delhi Zone))
- 184.** Night : Morning :: ? : Night  
 (1) Noon (2) Forenoon  
 (3) Afternoon (4) Evening  
 SSC (10+2) Level Data Entry  
 Operator & LDC Exam. 11.12.2011  
 (1st Sitting (Delhi Zone))
- 185.** Oxygen : Burn :: Carbondioxide : ?  
 (1) Isolate (2) Foam  
 (3) Extinguishes (4) Explode  
 SSC (10+2) Level Data Entry  
 Operator & LDC Exam. 11.12.2011  
 (1st Sitting (Delhi Zone))
- 186.** Yes : No :: Alive : ?  
 (1) Life (2) Live  
 (2) Dead (4) Funeral  
 SSC (10+2) Level Data Entry  
 Operator & LDC Exam. 11.12.2011  
 (1st Sitting (East Zone))
- 187.** Today : Day before yesterday :: January : ?  
 (1) December (2) February  
 (3) November (4) March  
 SSC (10+2) Level Data Entry  
 Operator & LDC Exam. 11.12.2011  
 (1st Sitting (East Zone))
- 188.** Man : House :: ?  
 (1) Cat : Mouse (2) Beast : Den  
 (3) Tree : Plant (4) Cage : Rat  
 SSC (10+2) Level Data Entry  
 Operator & LDC Exam. 11.12.2011  
 (1st Sitting (East Zone))
- 189.** Fodder : Cattle :: ?  
 (1) Pen : Ink  
 (2) Ball : Stick  
 (3) Fruit : Juice  
 (4) Grass : Horses  
 SSC (10+2) Level Data Entry  
 Operator & LDC Exam. 11.12.2011  
 (1st Sitting (East Zone))
- 190.** Stammering : Speech :: Deafness : ?  
 (1) Ear (2) Hearing  
 (3) Noise (4) Commotion  
 SSC (10+2) Level Data Entry  
 Operator & LDC Exam. 11.12.2011  
 (1st Sitting (East Zone))

- 191.** RIGHT : WRONG :: PLEASURE : ?  
 (1) HAPPY  
 (2) JOY  
 (3) WONDERFUL  
 (4) DISPLEASURE  
 SSC (10+2) Level Data Entry  
 Operator & LDC Exam. 11.12.2011  
 (1st Sitting (East Zone))
- 192.** Son : Nephew :: Daughter : ?  
 (1) Niece (2) Sister-in-law  
 (3) Sister (4) Mother  
 SSC Constable (GD) & Rifleman (GD)  
 Exam.22.04.2012 (1st Sitting)
- 193.** Ring : Ear :: ? : Wrist  
 (1) Pendant (2) Chain  
 (3) Bangle (4) Ribbon  
 SSC Constable (GD) & Rifleman (GD)  
 Exam.22.04.2012 (1st Sitting)
- 194.** Wood : Paper :: Steel : ?  
 (1) Metal (2) Nail  
 (3) Glass (4) Iron  
 SSC Constable (GD) & Rifleman (GD)  
 Exam. 22.04.2012 (1st Sitting)
- 195.** Sun : Day :: Moon : ?  
 (1) Stars (2) Night  
 (3) Planets (4) Darkness  
 SSC Constable (GD) & Rifleman (GD)  
 Exam. 22.04.2012 (1st Sitting)
- 196.** Jewellery : Gold :: Furniture : ?  
 (1) Wood (2) Paint  
 (3) Table (4) Tree  
 (SSC Level Data Entry Operator &  
 LDC Exam.21.10.2012 (1st Sitting))
- 197.** Author : Novel :: Choreographer : ?  
 (1) Make-up (2) Dance  
 (3) Music (4) Picture  
 (SSC Level Data Entry Operator &  
 LDC Exam.21.10.2012 (1st Sitting))
- 198.** Human : Carbohydrate :: Engine : ?  
 (1) Wheel (2) Carburettor  
 (3) Cylinder (4) Petrol  
 (SSC Level Data Entry Operator &  
 LDC Exam. 21.10.2012 (1st Sitting))
- 199.** Telephone : Mobile phone :: Computer : ?  
 (1) Keyboard (2) Television  
 (3) Printer (4) Laptop  
 (SSC Level Data Entry Operator &  
 LDC Exam. 21.10.2012 (1st Sitting))
- 200.** Food : Hunger :: Sleep : ?  
 (1) Weariness (2) Night  
 (3) Health (4) Dream  
 (SSC Level Data Entry Operator &  
 LDC Exam. 21.10.2012 (1st Sitting))

**ANALOGY OR SIMILARITY**

- 201.** Sapling : Tree :: Girl : ?  
 (1) Wife (2) Man  
 (3) Child (4) Woman  
 (SSC Level Data Entry Operator & LDC Exam. 21.10.2012 (IInd Sitting))
- 202.** Doctor : Hospital :: Chef : ?  
 (1) Knife (2) Kitchen  
 (3) Food (4) Cook  
 (SSC Level Data Entry Operator & LDC Exam. 21.10.2012 (IInd Sitting))
- 203.** Hen : Egg :: Tree : ?  
 (1) Bark (2) Seed  
 (3) Leaves (4) Fruit  
 (SSC Level Data Entry Operator & LDC Exam. 28.10.2012 (Ist Sitting))
- 204.** Nail Cutter : Nail :: Gillet : ?  
 (1) Blade (2) Head  
 (3) Razor (4) Knife  
 (SSC Level Data Entry Operator & LDC Exam. 28.10.2012 (Ist Sitting))
- 205.** Window : Pane :: Book : ?  
 (1) Novel (2) Glass  
 (3) Cover (4) Page  
 (SSC Level Data Entry Operator & LDC Exam. 28.10.2012 (Ist Sitting))
- 206.** Cot : Mattress :: Floor : ?  
 (1) Curtain (2) Bedspread  
 (3) Tiles (4) Carpet  
 (SSC Level Data Entry Operator & LDC Exam. 28.10.2012 (Ist Sitting))
- 207.** Salt : Hypertension :: Sugar : ?  
 (1) Cholesterol (2) Diabetes  
 (3) Sweet (4) Dehydration  
 (SSC Level Data Entry Operator & LDC Exam. 28.10.2012 (Ist Sitting))
- 208.** Prologue : Epilogue :: Dawn : ?  
 (1) Dusk (2) Evening  
 (3) Twilight (4) Morning  
 (SSC Level Data Entry Operator & LDC Exam. 04.11.2012 (IInd Sitting))
- 209.** Histogram : Bar Chart :: Calligraphy : ?  
 (1) Typewriting (2) Call-history  
 (3) Hand writing (4) Video call  
 (SSC Level Data Entry Operator & LDC Exam. 04.11.2012 (IInd Sitting))
- 210.** Temple : Ear ; Shoulder : Hand ; Gum : ?  
 (1) Lip (2) Tongue  
 (3) Vein (4) Tooth  
 (SSC Graduate Level Tier-I Exam. 11.11.2012 (Ist Sitting))
- 211.** Pea-hen : Pea-cock :: Bitch : ?  
 (1) He-elephant (2) Mongoose  
 (3) Dog (4) Wolf  
 (SSC Graduate Level Tier-I Exam. 11.11.2012 (Ist Sitting))
- 212.** Manipuri : Manipur :: Kathakali : ?  
 (1) Karnataka  
 (2) Tamil Nadu  
 (3) Kerala  
 (4) Andhra Pradesh  
 (SSC Graduate Level Tier-I Exam. 11.11.2012 (Ist Sitting))
- 213.** Teacher: Student: : Pontiff : ?  
 (1) Disciple (2) Follower  
 (3) Priest (4) Deity  
 (SSC Graduate Level Tier-I Exam. 11.11.2012 (Ist Sitting))
- 214.** Bees : Hum :: Owls : ?  
 (1) Roar (2) Talk  
 (3) Hiss (4) Hoot  
 (SSC Assistant Grade-III Exam. 11.11.2012 (IInd Sitting))
- 215.** Confirmed : Inveterate :: Financial : ?  
 (1) Callow (2) Incredible  
 (3) Bankrupt (4) Knot  
 (SSC Assistant Grade-III Exam. 11.11.2012 (IInd Sitting))
- 216.** Furniture : Bench :: Stationery : ?  
 (1) Pen (2) Chair  
 (3) Godown (4) Office  
 (SSC Assistant Grade-III Exam. 11.11.2012 (IInd Sitting))
- 217.** Coal : Black diamond :: Petroleum : ?  
 (1) Solid gold (2) Black gold  
 (3) Liquid gold (4) White gold  
 (SSC Assistant Grade-III Exam. 11.11.2012 (IInd Sitting))
- 218.** Poster : Wall :: Photograph : ?  
 (1) Camera (2) Film  
 (3) Negative (4) Frame  
 (SSC Assistant Grade-III Exam. 11.11.2012 (IInd Sitting))
- 219.** tide : edit :: spit : ?  
 (1) tpis (2) tips  
 (3) tsip (4) tpsi  
 (FCI Assistant Grade-II Exam. 22.01.2012 Paper-I)
- 220.** Poet : Imagination :: Historian : ?  
 (1) Statistics (2) Commerce  
 (3) Facts (4) Science  
 (FCI Assistant Grade-II Exam. 22.01.2012 Paper-I)
- 221.** Gifted : Intelligent :: Creative : ?  
 (1) Artistic (2) Scientific  
 (3) Productive (4) Repetitive  
 (FCI Assistant Grade-II Exam. 22.01.2012 Paper-I)
- 222.** Triangle : Hexagon :: ?  
 (1) Cone : Sphere  
 (2) Rectangle : Octagon  
 (3) Pentagon : Heptagon  
 (4) Angle : Quadrilateral  
 (FCI Assistant Grade-II Exam. 22.01.2012 Paper-I)
- 223.** Student : Book :: Postman : ?  
 (1) Delivery (2) Bicycle  
 (3) Uniform (4) Mail  
 (FCI Assistant Grade-III Exam. 25.02.2012 (Paper-I))  
**North Zone (Ist Sitting)**
- 224.** Illiteracy % : Education :: Drought : ?  
 (1) Well (2) Rain  
 (3) Dam (4) River  
 (FCI Assistant Grade-III Exam. 25.02.2012 (Paper-I))  
**North Zone (Ist Sitting)**
- 225.** Carpenter : Furniture :: ?  
 (1) Book : Author  
 (2) Magazine : Editor  
 (3) Cook : Soup  
 (4) Dam : Engineer  
 (FCI Assistant Grade-III Exam. 25.02.2012 (Paper-I))  
**North Zone (Ist Sitting)**
- 226.** Coffee : Coffeine :: Tobacco : ?  
 (1) Tanin (2) Novocaine  
 (3) Alexin (4) Nicotin  
 (FCI Assistant Grade-III Exam. 05.02.2012 (Paper-I))  
**East Zone (IInd Sitting)**
- 227.** INTIMATE : UNFAMILIAR :: ?  
 (1) Interior : Remote  
 (2) Forbear : Patience  
 (3) Interested : Indifference  
 (4) Popular : Friendly  
 (FCI Assistant Grade-III Exam. 05.02.2012 (Paper-I))  
**East Zone (IInd Sitting)**
- 228.** Coconut : Oil :: Fruit : ?  
 (1) Sweet (2) Taste  
 (3) Juice (4) Bunch  
 (FCI Assistant Grade-III Exam. 05.02.2012 (Paper-I))  
**East Zone (IInd Sitting)**
- 229.** Symphony : Composer :: Painter : ?  
 (1) Fresco (2) Colours  
 (2) Art (4) Leonardo  
 (SSC (10+2) Level Data Entry Operator & LDC Exam. 04.11.2012, Ist Sitting)

**ANALOGY OR SIMILARITY**

- 230. Elephant: Tusk :: Parrot: ?**  
 (1) Quill (2) Feather  
 (3) Beak (4) Spine  
 (SSC (10+2) Level Data Entry Operator & LDC Exam. 04.11.2012, 1st Sitting)
- 231. Virus : Smallpox :: Bacteria : ?**  
 (1) Chickenpox  
 (2) Typhoid  
 (3) Malaria  
 (4) Sleeping sickness  
 (SSC Multi-Tasking Staff Exam. 10.03.2013, 1st Sitting : Patna)
- 232. Home : Kitchen :: Plant : ?**  
 (1) Root (2) Soil  
 (3) Leaf (4) Stem  
 (SSC Multi-Tasking Staff Exam. 10.03.2013, 1st Sitting : Patna)
- 233. Book : Shelf :: Clothes : ?**  
 (1) Hanger (2) Cupboard (3) Wardrobe (4) Bureau  
 (SSC Multi-Tasking Staff Exam. 10.03.2013, 1st Sitting : Patna)
- 234. Gramophone : Record : : Video : ?**  
 (1) T.V. (2) Recording  
 (3) Cassette (4) Camera  
 (SSC Multi-Tasking Staff Exam. 10.03.2013)
- 235. Axe : Chop : : Needle : ?**  
 (1) trim (2) draw  
 (3) plough (4) knit  
 (SSC Multi-Tasking Staff Exam. 10.03.2013)
- 236. Bird : Feather : : Fish : ?**  
 (1) Gill (2) Scale  
 (3) Tail (4) Fin  
 (SSC Multi-Tasking Staff Exam. 17.03.2013, Kolkata Region)
- 237. Arousal : Need : : Effort : ?**  
 (1) Personality (2) Motive  
 (3) Success (4) Probability  
 (SSC Multi-Tasking Staff Exam. 17.03.2013, Kolkata Region)
- 238. Wheat : Cereal : : Water : ?**  
 (1) Petrol (2) Liquid  
 (3) Diesel (4) Kerosene  
 (SSC Multi-Tasking Staff Exam. 17.03.2013, Kolkata Region)
- 239. Up : Down : : Back : ?**  
 (1) Deep (2) Front  
 (3) Right (4) Left  
 (SSC Multi-Tasking Staff Exam. 17.03.2013, IInd Sitting)
- 240. Astronomy : Stars : : Geology : ?**  
 (1) Geometry (2) Science  
 (3) Earth (4) Sky  
 (SSC Multi-Tasking Staff Exam. 17.03.2013, IInd Sitting)
- 241. FATIGUE : REST :: DEHYDRATE : ?**  
 (1) WEIGHT (2) HEAT  
 (3) WATER (4) LIGHT  
 (SSC Multi-Tasking Staff Exam. 24.03.2013, 1st Sitting)
- 242. AUTHOR : BOOK : TAILOR : ?**  
 (1) CLOTH (2) SHIRT  
 (3) MERCHANT (4) STITCHING  
 (SSC Multi-Tasking Staff Exam. 24.03.2013, 1st Sitting)
- 243. REPEL : ATTRACT : ELASTIC : ?**  
 (1) STRETCH (2) RIGID  
 (3) EXPAND (4) WIDEN  
 (SSC Multi-Tasking Staff Exam. 24.03.2013, 1st Sitting)
- 244. UMPIRE : GAME : : ?**  
 (1) Legislator : election  
 (2) Moderator : debate  
 (3) Prodigy : wonder  
 (4) Chef : banquet  
 (SSC Graduate Level Tier-I Exam. 21.04.2013, 1st Sitting)
- 245. Horse : Neigh :: Bells : ?**  
 (1) Chime (2) Rustle  
 (3) Roar (4) Beat  
 (SSC Graduate Level Tier-I Exam. 21.04.2013, 1st Sitting)
- 246. Video : Cassette :: Computer : ?**  
 (1) Files (2) Floppy  
 (3) Bits (4) Adit  
 (SSC Graduate Level Tier-I Exam. 21.04.2013, IInd Sitting)
- 247. Glucometer : Blood Sugar :: Sphygmomanometer : ?**  
 (1) Earthquake  
 (2) Blood Pressure  
 (3) Atmospheric Pressure  
 (4) Specific Gravity  
 (SSC Graduate Level Tier-I Exam. 21.04.2013, IInd Sitting)
- 248. Behaviour: Psychology :: Plant : ?**  
 (1) Plant (2) Botany  
 (3) Zoology (4) Physiology  
 (SSC Graduate Level Tier-I Exam. 21.04.2013, IInd Sitting)
- 249. Mitochondria : Energy :: DNA : ?**  
 (1) Inheritance  
 (2) Reproduction  
 (3) Locomotion  
 (4) Immunity  
 (SSC Graduate Level Tier-I Exam. 21.04.2013, IInd Sitting)
- 250. Desert: Mirage :: Ocean : ?**  
 (1) El-Nino (2) Whale  
 (3) Blizard (4) Hail  
 (SSC Graduate Level Tier-I Exam. 21.04.2013, IInd Sitting)
- 251. Chisel : Sculptor :: Harrow : ?**  
 (1) Gardener (2) Mason  
 (3) Blacksmith (4) Guard  
 (SSC Graduate Level Tier-I Exam. 21.04.2013, IInd Sitting)
- 252. Moon : Satellite :: Earth : ?**  
 (1) Sun (2) Planet  
 (3) Solar system (4) Round  
 (SSC Graduate Level Tier-I Exam. 21.04.2013, IInd Sitting)
- 253. Psychology : Mind :: Arithmetic: ?**  
 (1) Knowledge (2) Number  
 (3) Height (4) Formulas  
 (SSC Constable (GD) Exam. 12.05.2013)
- 254. Ice : Coldness :: Earth : ?**  
 (1) Weight (2) Jungle  
 (3) Gravitation (4) Sea  
 (SSC Constable (GD) Exam. 12.05.2013)
- 255. Teacher : School :: Nurse : ?**  
 (1) Doctors (2) Patients  
 (3) Medicine (4) Hospitals  
 (SSC Constable (GD) Exam. 12.05.2013)
- 256. Window : Carpenter :: Statue : ?**  
 (1) Sculptor (2) Mason  
 (3) Blacksmith (4) Goldsmith  
 (SSC Constable (GD) Exam. 12.05.2013)
- 257. Eye : Cataract : : Skin : ?**  
 (1) Pyorrhea (2) Sinusitis  
 (3) Eczema (4) Trachoma  
 (SSC Constable (GD) Exam. 12.05.2013 1st Sitting)
- 258. Vitamin A : Carrot :: Vitamin C : ?**  
 (1) Meat (2) Fish  
 (3) Egg (4) Orange  
 (SSC Constable (GD) Exam. 12.05.2013 1st Sitting)
- 259. Wine : Grape : : Whiskey : ?**  
 (1) Orange (2) Potato  
 (3) Oats (4) Apple  
 (SSC Graduate Level Tier-I Exam. 19.05.2013, 1st Sitting)
- 260. Defer : Put off : : Deduce : ?**  
 (1) Infer (2) Protect  
 (3) Delate (4) Oppose  
 (SSC Graduate Level Tier-I Exam. 19.05.2013, IInd Sitting)

**ANALOGY OR SIMILARITY**

- 261.** Fish : Gills :: Human : ?  
 (1) Heart (2) Lungs  
 (3) Nose (4) Mouth  
 (SSC Graduate Level Tier-I Exam. 19.05.2013, IIInd Sitting)
- 262.** King : Throne :: Rider : ?  
 (1) Saddle (2) Chair  
 (3) Horse (4) Seat  
 (SSC Graduate Level Tier-I Exam. 19.05.2013, Ist Sitting)
- 263.** Tanning : Leather :: Pyrotechnics : ?  
 (1) Machinery (2) Bombs  
 (3) Fireworks (4) Wool  
 (SSC Graduate Level Tier-I Exam. 19.05.2013, Ist Sitting)
- 264.** Victory : Joy :: ? : Sorrow  
 (1) Defeat (2) Depression  
 (3) Melancholy (4) Cry  
 (SSC CAPFs SI & CISF ASI Exam. 23.06.2013)
- 265.** Body : Stomach :: Library : ?  
 (1) Cash (2) Book  
 (3) Headmaster (4) School  
 (SSC CAPFs SI & CISF ASI Exam. 23.06.2013)
- 266.** Chipko Movement : Sundarlal Bahuguna :: Narmada Bachao Andolan : ?  
 (1) Vinoba Bhave  
 (2) R.N. Pachauri  
 (3) Pattabhi Sitaramiah  
 (4) Medha Patkar  
 (SSC Cabinet Secretariat RO (ECO), DFO (T) & DFO (GD) Tier-I Exam. 23.06.2013)
- 267.** Hooghly : Jute :: Ahmedabad : ?  
 (1) Cotton (2) Coffee  
 (3) Tea (4) Wheat  
 (SSC Cabinet Secretariat RO (ECO), DFO (T) & DFO (GD) Tier-I Exam. 23.06.2013)
- 268.** Rain : Agriculture :: Market : ?  
 (1) Production  
 (2) Economy  
 (3) Cultivation  
 (4) Industrialisation  
 (SSC Cabinet Secretariat RO (ECO), DFO (T) & DFO (GD) Tier-I Exam. 23.06.2013)
- Directions :** In each of the following questions, select the related word from the given alternatives.
- 269.** Teacher : Student :: Lawyer : ?  
 (1) Customer (2) Consumer  
 (3) Client (4) Claimant  
 (SSC Multi-Tasking (Non-Tech.) Staff Exam. 16.02.2014)

- 270.** Mango : Fruit :: Jasmin : ?  
 (1) Trees (2) Fragrance  
 (3) Flower (4) Rose  
 (SSC Multi-Tasking (Non-Tech.) Staff Exam. 16.02.2014)
- 271.** Dress : Tailor :: ? : Carpenter  
 (1) Wood (2) Furniture  
 (3) Leather (4) Cloth  
 (SSC Multi-Tasking Staff (Patna) Exam. 16.02.2014)
- 272.** Bow : Arrow :: Pistol : ?  
 (1) Bullet (2) Gun  
 (3) Shoot (4) Rifle  
 (SSC Multi-Tasking Staff (Patna) Exam. 16.02.2014)
- 273.** Plant : Seed :: ? : Bud  
 (1) Leaf (2) Twig  
 (3) Flower (4) Fruit  
 (SSC Multi-Tasking (Non-Tech.) Staff Exam. 23.02.2014, IIInd Sitting)
- 274.** Magazine : Editor :: Drama : ?  
 (1) Director (2) Player  
 (3) Manager (4) Actor  
 (SSC Multi-Tasking (Non-Tech.) Staff Exam. 23.02.2014, IIInd Sitting)
- 275.** Reference material : Dictionary :: Periodical : \_\_\_\_?  
 (1) Book (2) Atlas  
 (3) Biography (4) Newspaper  
 (SSC CGL Tier-I Re-Exam-2013, 27.04.2014)
- 276.** Tea : Cup :: Soup : \_\_\_\_?  
 (1) Glass (2) Spoon  
 (3) Bowl (4) Mug  
 (SSC CGL Tier-I Re-Exam-2013, 27.04.2014)
- 277.** Sheep : mutton :: Deer : \_\_\_\_?  
 (1) meat (2) flesh  
 (3) venison (4) veal  
 (SSC CGL Tier-I Re-Exam-2013, 27.04.2014 & Bihar SSC 2nd Graduate level (Pre) Exam. 16.02.2015)
- 278.** Cobbler : Leather :: Tailor : \_\_\_\_?  
 (1) Cloth (2) Shirt  
 (3) Draper (4) Thread  
 (SSC CGL Tier-I Re-Exam-2013, 27.04.2014 & Bihar SSC 2nd Graduate level (Pre) Exam. 16.02.2015)
- 279.** Saint : Meditation :: Scientist : ?  
 (1) Research (2) Knowledge  
 (3) Spiritual (4) Rational  
 (SSC CAPFs SI, CISF ASI & Delhi Police SI Exam. 22.06.2014)

- 280.** King : Palace :: Eskimo : ?  
 (1) Caravan (2) Asylum  
 (3) Monastery (4) Igloo  
 (SSC CAPFs SI, CISF ASI & Delhi Police SI Exam. 22.06.2014)
- 281.** Soil : Erosion :: Forest : ?  
 (1) Pollution  
 (2) Degradation  
 (3) Dense  
 (4) Deforestation  
 (SSC CAPFs SI, CISF ASI & Delhi Police SI Exam. 22.06.2014)
- 282.** Plane : Hangar :: Car : ?  
 (1) Road (2) Garage  
 (3) Tyre (4) Brake  
 (SSC CAPFs SI, CISF ASI & Delhi Police SI Exam. 22.06.2014)
- 283.** Natural : Artificial :: Cotton : ?  
 (1) Wool (2) Nylon  
 (3) Silk (4) Jute  
 (SSC GL Tier-I Re-Exam. (2013) 20.07.2014, Ist Sitting)
- 284.** Crime : Punishment :: Honesty : ?  
 (1) Award (2) Recognition  
 (3) Reward (4) Pride  
 (SSC GL Tier-I Re-Exam. (2013) 20.07.2014, Ist Sitting)
- 285.** Amnesia : Memory :: Paralysis : ?  
 (1) Legs (2) Movement  
 (3) Limbs (4) Handicapped  
 (SSC GL Tier-I Re-Exam. (2013) 20.07.2014, IIInd Sitting)
- 286.** Vigilant : Alert :: Viable : ?  
 (1) Beautiful (2) Useful  
 (3) Simple (4) Feasible  
 (SSC GL Tier-I Re-Exam. (2013) 20.07.2014, IIInd Sitting)
- 287.** Embarrassed : Humiliated :: Frightened : ?  
 (1) Terrified (2) Agitated  
 (3) Courageous (4) Reckless  
 (SSC GL Tier-I Exam. 19.10.2014, Ist Sitting)
- 288.** Macabre : Lovely :: Baneful : ?  
 (1) Unharmful (2) Churlish  
 (3) Filter (4) Ugly  
 (SSC GL Tier-I Exam. 19.10.2014, Ist Sitting)
- 289.** Demographer : People :: Philatelist : ?  
 (1) Fossils (2) Stamps  
 (3) Photography (4) Music  
 (SSC GL Tier-I Exam. 19.10.2014)

**ANALOGY OR SIMILARITY**

- 290.** Sepal : Flower ::  
 (1) Foot : Ball  
 (2) Tyre : Bicycle  
 (3) Puppy : Dog  
 (4) Sandals : Shoes  
 (SSC GL Tier-I Exam. 19.10.2014)
- 291.** Seismometer : Earthquakes ::  
 Thermometer : ?  
 (1) Mercury (2) Temperature  
 (3) Fever (4) Doctor  
 (SSC GL Tier-I Exam. 26.10.2014)
- 292.** Play : Actor :: Concert : ?  
 (1) Percussion (2) Symphony  
 (3) Musician (4) Piano  
 (SSC GL Tier-I Exam. 26.10.2014)
- 293.** Germany : Mark :: Morocco : ?  
 (1) Dollar (2) Lira  
 (3) Dirham (4) Kroon  
 (SSC CHSL (10+2) DEO & LDC  
 Exam. 02.11.2014, Patna Region :  
 Ist Sitting)
- 294.** Red Blood Cells : Erythrocytes ::  
 White Blood Cells : ?  
 (1) Thrombocytes  
 (2) Lymphocytes  
 (3) Monocytes  
 (4) Leucocytes  
 (SSC CHSL (10+2) DEO & LDC  
 Exam. 02.11.2014, Patna Region :  
 Ist Sitting)
- 295.** Moon : Chandrayan :: Mars : ?  
 (1) Apple (2) Aryabhata  
 (3) Mangalyan (4) Bhaskara  
 (SSC CHSL (10+2) DEO & LDC  
 Exam. 02.11.2014, Patna Region :  
 Ist Sitting)
- 296.** Lion : Forest :: Fish : ?  
 (1) Cage (2) Nest  
 (3) Sky (4) Water  
 (SSC CHSL (10+2) DEO & LDC  
 Exam. 02.11.2014, IInd Sitting)
- 297.** Polio : Virus :: Anthrax : ?  
 (1) Fungus (2) Bacteria  
 (3) Virus (4) Insect  
 (SSC CHSL (10+2) DEO & LDC  
 Exam. 02.11.2014, IInd Sitting)
- 298.** River : Tributary :: Tree : ?  
 (1) Stem (2) Root  
 (3) Branch (4) Flower  
 (SSC CHSL (10+2) DEO & LDC  
 Exam. 02.11.2014, IInd Sitting)
- 299.** Maharashtra : India :: Texas : ?  
 (1) Canada (2) Mexico  
 (3) Brazil (4) USA  
 (SSC CHSL (10+2) DEO & LDC  
 Exam. 09.11.2014)

- 300.** Qualm : Nausea :: Burn : ?  
 (1) Fresh (2) Sear  
 (3) Sensible (4) Wet  
 (SSC CHSL (10+2) DEO & LDC  
 Exam. 09.11.2014)
- 301.** Heart : Cardiologist :: Kidney : ?  
 (1) Endocrinologist  
 (2) Orthodontist  
 (3) Nephrologist  
 (4) Neurologist  
 (SSC CHSL (10+2) DEO & LDC  
 Exam. 09.11.2014)
- 302.** Doctor : Hospital :: Teacher : ?  
 (1) Field (2) Laboratory  
 (3) School (4) Industry  
 (SSC CHSL (10+2) DEO & LDC  
 Exam. 16.11.2014, Patna Region :  
 Ist Sitting)
- 303.** 1st Prime Minister of India : Pt.  
 Jawaharlal Nehru :: 1st President  
 of India : ?  
 (1) Dr. S. Radhakrishnan  
 (2) Dr. Rajendra Prasad  
 (3) Dr. Zakir Hussain  
 (4) Dr. A.P.J. Abdul Kalam  
 (SSC CHSL (10+2) DEO & LDC  
 Exam. 16.11.2014, Patna Region :  
 Ist Sitting)
- 304.** International Literacy Day : Sep-  
 tember 8 :: International Wom-  
 en's Day : ?  
 (1) March 8 (2) June 26  
 (3) April 22 (4) November 4  
 (SSC CHSL (10+2) DEO & LDC  
 Exam. 16.11.2014, Patna Region :  
 Ist Sitting)
- 305.** Ravishankar : Sitar :: Bismillah  
 Khan : ?  
 (1) Sarod (2) Santoor  
 (3) Shehnai (4) Flute  
 (SSC CHSL (10+2) DEO & LDC  
 Exam. 16.11.2014)
- 306.** India : Mango :: New Zealand : ?  
 (1) Apples (2) Kiwi  
 (3) Grapes (4) Bananas  
 (SSC CHSL (10+2) DEO & LDC  
 Exam. 16.11.2014)
- 307.** Put the correct words in the  
 blanks :  
 Christmas : ? : ? : Biryani  
 (1) Christian, Muslim  
 (2) Cashew, Rice  
 (3) Jesus, Ramzan  
 (4) Cake, Id-ul-Fitre  
 (SSC CHSL (10+2) DEO & LDC  
 Exam. 16.11.2014)

**Directions** % In each of the fol-  
 lowing questions, select the related  
 word from the given alternatives.

- 308.** Voyage : Sea sickness : Heights : ?  
 (1) Ship (2) Travel  
 (3) Giddiness (4) Motion  
 (SSC CGL Tier-I Exam. 19.10.2014  
 TF No. 022 MH 3)
- 309.** Waitress : Restaurant :: ?  
 (1) Doctor : Nurse  
 (2) Driver : School  
 (3) Teacher : School  
 (4) Actor : Role  
 (SSC CGL Tier-I Exam. 19.10.2014  
 TF No. 022 MH 3)
- 310.** String % Violin :: ? % Piano  
 (1) Music (2) Tune  
 (3) Chord (4) Key  
 (SSC CHSL (10+2) DEO & LDC  
 Exam. 16.11.2014, Ist Sitting  
 TF No. 333 LO 2)
- 311.** Frame % Picture % % ?  
 (1) Box % Lid  
 (2) Chair % Cushion  
 (3) Cover % Book  
 (4) Window % Screen  
 (SSC CHSL (10+2) DEO & LDC  
 Exam. 16.11.2014, Ist Sitting  
 TF No. 333 LO 2)
- 312.** Bihu % Assam % % Onam % ?  
 (1) Karnataka  
 (2) Kerala  
 (3) Jammu & Kashmir  
 (4) Rajasthan  
 (SSC CHSL (10+2) DEO & LDC  
 Exam. 16.11.2014, Ist Sitting  
 TF No. 333 LO 2)
- 313.** Cataract : Eye :: Pneumonia : ?  
 (1) Brain  
 (2) Ear  
 (3) Lungs  
 (4) Nerves and limbs  
 (SSC CHSL (10+2) DEO & LDC  
 Exam. 16.11.2014, IInd Sitting  
 TF No. 545 QP 6)
- 314.** Whale : Mammal :: Turtle : ?  
 (1) Amphibian (2) Reptile  
 (3) Fish (4) Mollusc  
 (SSC CHSL (10+2) DEO & LDC  
 Exam. 16.11.2014, IInd Sitting  
 TF No. 545 QP 6)

**ANALOGY OR SIMILARITY**

- 315.** Dominance : Hegemony :: Independence : ?  
 (1) Sympathy (2) Melancholy  
 (3) Autonomy (4) Recompense  
 (SSC CHSL (10+2) DEO & LDC Exam. 16.11.2014, IIInd Sitting TF No. 545 QP 6)
- 316.** STAR : RATS :: WARD : ?  
 (1) DRAW (2) MICE  
 (3) FAME (4) SHINE  
 (SSC CAPFs SI, CISF ASI & Delhi Police SI Exam, 21.06.2015 (Ist Sitting) TF No. 8037731)
- 317.** Eye % Ophthalmologist :: Music %  
 (1) Player (2) Conductor  
 (3) Pianist (4) Composer  
 (SSC CAPFs SI, CISF ASI & Delhi Police SI Exam, 21.06.2015 IIInd Sitting)
- 318.** Many – Germany :: Land – ?  
 (1) Plants (2) Ireland  
 (3) Land - Lord (4) Landscape  
 (SSC CAPFs SI, CISF ASI & Delhi Police SI Exam, 21.06.2015 IIInd Sitting)
- 319.** Haematology : Blood :: Phycology : ?  
 (1) Diseases (2) Fungi  
 (3) Fishes (4) Algae  
 (SSC CGL Tier-I Exam, 09.08.2015 (Ist Sitting) TF No. 1443088)
- 320.** PALAEOLOGY : FOSSIL :: PHRENOLOGY : ?  
 (1) SKULL (2) THYROID  
 (3) PANCREAS (4) LUNGS  
 (SSC CGL Tier-I Exam, 09.08.2015 (IIInd Sitting) TF No. 4239378)
- 321.** Identify the pair which 'DOES NOT' exhibit the same relationship as the Capitalised pair :  
**ETYMOLOGY : WORDS**  
 (1) PSYCHOLOGY : MIND  
 (2) ANATOMY : BODY  
 (3) ARCHAEOLOGY : ANTIQUES  
 (4) PHILOSOPHY : LANGUAGE  
 (SSC CGL Tier-I Exam, 09.08.2015 (IIInd Sitting) TF No. 4239378)
- 322.** Garbage : House :: Gangue : ?  
 (1) Ore (2) Drugs  
 (3) Factory (4) Office  
 (SSC CGL Tier-I Exam, 16.08.2015 (Ist Sitting) TF No. 3196279)
- 323.** Kidneys : Nephron :: Central Nervous System : ?  
 (1) Spinal cord (2) Cerebrum  
 (3) Brain (4) Neurons  
 (SSC CGL Tier-I Exam, 16.08.2015 (IIInd Sitting) TF No. 2176783)
- 324.** Insects : Entomology :: Snakes : ?  
 (1) Agrology (2) Ophiology  
 (3) Mycology (4) Cetology  
 (SSC CGL Tier-I Exam, 16.08.2015 (IIInd Sitting) TF No. 2176783)
- 325.** Book : Paper :: Bread : ?  
 (1) Flour (2) Biscuit  
 (3) Cake (4) Butter  
 (SSC CGL Tier-I Re-Exam, 30.08.2015)
- 326.** Hot : Cold :: ?  
 (1) Summer : Sun  
 (2) Germs : Disease  
 (3) Light : Dark  
 (4) Thin : Big  
 (SSC CGL Tier-I Re-Exam, 30.08.2015)
- 327.** FRENCH : FRANCE :: DUTCH : ?  
 (1) FIJI (2) NORWAY  
 (3) HOLLAND (4) SWEDEN  
 (SSC Constable (GD) Exam, 04.10.2015, Ist Sitting)
- 328.** BOOK : LIBRARY :: TREE : ?  
 (1) SHADE (2) FRUIT  
 (3) FOREST (4) FURNITURE  
 (SSC Constable (GD) Exam, 04.10.2015, Ist Sitting)
- 329.** CARD : JOKER :: BOOK : ?  
 (1) WORDS (2) WRITER  
 (3) PAGES (4) COVER  
 (SSC Constable (GD) Exam, 04.10.2015, IIInd Sitting)
- 330.** WALLET : MONEY :: ENVELOPE : ?  
 (1) GUM (2) POSTOFFICE  
 (3) SUITCASE (4) LETTER  
 (SSC Constable (GD) Exam, 04.10.2015, IIInd Sitting)
- 331.** Heart : Cardiologist :: Brain : ?  
 (1) Ophthalmologist  
 (2) Nephrologist  
 (3) Neurologist  
 (4) Gynaecologist  
 (SSC (10+2) LDC/DEO/PA/SA Exam. 01.11.2015 TF No. 1098066)
- 332.** Car : Garage :: ? : Hangar  
 (1) Train (2) Truck  
 (3) Aeroplane (4) Bus  
 (SSC (10+2) LDC/DEO/PA/SA Exam. 01.11.2015 TF No. 1098066)
- 333.** Governor : State :: President : ?  
 (1) Organisation  
 (2) Constituency  
 (3) District  
 (4) Country  
 (SSC (10+2) LDC/DEO/PA/SA Exam. 01.11.2015 TF No. 1098066)
- 334.** Vacation : Holiday :: Vocation : ?  
 (1) Money (2) Pleasure  
 (3) Degree (4) Career  
 (SSC CHSL (10+2) LDC, DEO & PA/SA Exam, 01.11.2015, IIInd Sitting)
- 335.** Eyes : Tears :: \_\_\_ : \_\_\_  
 (1) Heart : Artery  
 (2) Sea : Water  
 (3) Volcano : Lava  
 (4) Hunger : Bread  
 (SSC CHSL (10+2) LDC, DEO & PA/SA Exam, 01.11.2015, IIInd Sitting)
- 336.** Perch : Fresh water :: ? : Salt water  
 (1) Snake (2) Crocodile  
 (3) Frog (4) Cod  
 (SSC CHSL (10+2) LDC, DEO & PA/SA Exam, 01.11.2015, IIInd Sitting)
- 337.** Exercise : Gym :: Eating : ?  
 (1) Restaurant (2) Food  
 (3) Dieting (4) Fitness  
 (SSC CHSL (10+2) LDC, DEO & PA/SA Exam, 15.11.2015 (Ist Sitting) TF No. 6636838)
- 338.** School : Teacher :: Bank : ?  
 (1) Peon (2) Banker  
 (3) Manager (4) Cashier  
 (SSC CHSL (10+2) LDC, DEO & PA/SA Exam, 15.11.2015 (Ist Sitting) TF No. 6636838)
- 339.** Patient : Fowler Bed :: ?  
 (1) Certificate : Merit  
 (2) Necklace : Adornment  
 (3) Baby : Cradle  
 (4) Trophy : Achievement  
 (SSC CHSL (10+2) LDC, DEO & PA/SA Exam, 15.11.2015 (Ist Sitting) TF No. 6636838)
- 340.** Female : Feminine :: Male : ?  
 (1) Manager (2) Man  
 (3) Masculine (4) Macho  
 (SSC CHSL (10+2) LDC, DEO & PA/SA Exam, 15.11.2015 (IIInd Sitting) TF No. 7203752)

**ANALOGY OR SIMILARITY**

- 341.** Carpentry : Skill :: ? : Talent  
 (1) Masonry (2) Singing  
 (3) Plumbing (4) Driving  
 (SSC CHSL (10+2) LDC, DEO & PA/SA Exam, 15.11.2015 (IInd Sitting) TF No. 7203752)
- 342.** Concord : Agreement :: Discord : ?  
 (1) Blended (2) Comparison  
 (3) Conflict (4) Association  
 (SSC CHSL (10+2) LDC, DEO & PA/SA Exam, 15.11.2015 (IInd Sitting) TF No. 7203752)
- 343.** Fan : Wings :: Wheel : ?  
 (1) Cars (2) Air  
 (3) Spokes (4) Round  
 (SSC CHSL (10+2) LDC, DEO & PA/SA Exam, 06.12.2015 (Ist Sitting) TF No. 1375232)
- 344.** Mathematics : Logic :: Science : ?  
 (1) Experiments (2) Laboratory  
 (3) Scientists (4) Facts  
 (SSC CHSL (10+2) LDC, DEO & PA/SA Exam, 06.12.2015 (Ist Sitting) TF No. 1375232)
- 345.** Window : Pane :: Book : ?  
 (1) Cover (2) Novel  
 (3) Page (4) Glass  
 (SSC CHSL (10+2) LDC, DEO & PA/SA Exam, 06.12.2015 (Ist Sitting) TF No. 1375232)
- 346.** Hockey : India :: Baseball : ?  
 (1) China (2) Australia  
 (SSC CHSL (10+2) LDC, DEO & PA/SA Exam, 06.12.2015 (IInd Sitting) TF No. 3441135)
- 347.** Ant : Fly : Bee :: Hamster : Squirrel : ?  
 (1) Rodent (2) Cat  
 (3) Mouse (4) Spider  
 (SSC CHSL (10+2) LDC, DEO & PA/SA Exam, 06.12.2015 (IInd Sitting) TF No. 3441135)
- 348.** Brick : Wall :: Cell : ?  
 (1) DNA (2) Organs  
 (3) Chlorophyll (4) Tissue  
 (SSC CHSL (10+2) LDC, DEO & PA/SA Exam, 06.12.2015 (IInd Sitting) TF No. 3441135)
- 349.** Motor : Coil :: ?  
 (1) Table : Chair  
 (2) Regiment : Soldier  
 (3) Wheel : Car  
 (4) Wheel : Bearing  
 (SSC CHSL (10+2) LDC, DEO & PA/SA Exam, 20.12.2015 (Ist Sitting) TF No. 9692918)

- 350.** Blacksmith : Hammer :: ?  
 (1) Cloth : Tailor  
 (2) Surgeon : Forceps  
 (3) Carpenter : Wood  
 (4) Pen : Writer  
 (SSC CHSL (10+2) LDC, DEO & PA/SA Exam, 20.12.2015 (Ist Sitting) TF No. 9692918)
- 351.** Bullock : Cart :: Horse : ?  
 (1) Tonga (2) Ride  
 (3) Race (4) Plough  
 (SSC CHSL (10+2) LDC, DEO & PA/SA Exam, 20.12.2015 (Ist Sitting) TF No. 9692918)
- 352.** Yard : Inch :: Quart : ?  
 (1) Gallon (2) Ounce  
 (3) Milk (4) Liquid  
 (SSC (10+2) Stenographer Grade 'C' & 'D' Exam. 31.01.2016 TF No. 3513283)
- 353.** Pesticide : Crop :: Antiseptic : ?  
 (1) Wound (2) Clothing  
 (3) Bandage (4) Bleeding  
 (SSC (10+2) Stenographer Grade 'C' & 'D' Exam. 31.01.2016 TF No. 3513283)
- 354.** Optimist : Cheerful :: Pessimist : ?  
 (1) Gloomy (2) Mean  
 (3) Petty (4) Helpful  
 (SSC (10+2) Stenographer Grade 'C' & 'D' Exam. 31.01.2016 TF No. 3513283)
- Directions (355-357) :** In each of the following questions, select the related word from the given alternatives.
- (SSC (10+2) Stenographer Grade 'C' & 'D' Exam. 31.07.2016)
- 355.** Prediction : Future :: Regret : ?  
 (1) Present (2) Sin  
 (3) Time (4) Past
- 356.** Adversary : Enemy :: Adversity : ?  
 (1) Dynamic (2) Love  
 (3) Difficulty (4) Friend
- 357.** Bird : Worm :: ?  
 (1) Trap : Cheese  
 (2) Lion : Cave  
 (3) Cat : Mouse  
 (4) Horse : Stable
- 358.** Select the related word from the given alternatives:  
 Cytology : Cells :: ? : Birds  
 (1) Odontology (2) Mycology  
 (3) Etymology (4) Ornithology  
 (SSC CGL Tier-I (CBE) Exam. 10.09.2016)

- 359.** Select the related word from the given alternatives:  
 Bird : Aeroplane :: Fish : ?  
 (1) Fisherman (2) Sofa  
 (3) Boat (4) Glasses  
 (SSC CGL Tier-I (CBE) Exam. 11.09.2016) (Ist Sitting)
- 360.** Select the related word from the given alternatives.  
 Pilgrims : Caravan :: Rioters : ?  
 (1) Brood (2) Gang  
 (3) Mob (4) Troupe  
 (SSC CPO SI, ASI Online Exam. 05.06.2016) (IInd Sitting)
- 361.** Select the related words/numbers from the given alternatives  
 Horse : Movement of horse :: Lamb : ?  
 (1) Lumber (2) Flit  
 (3) Amble (4) Frisk  
 (SSC CPO SI, ASI Online Exam. 05.06.2016) (IInd Sitting)
- 362.** Select the related word from the given alternatives.  
 Farmer : Field :: Engineer : ?  
 (1) College (2) Cite  
 (3) Cabin (4) Site  
 (SSC CPO Exam. 06.06.2016) (Ist Sitting)
- 363.** Select the related word from the given alternatives.  
 Alluring : Beautiful :: Playful : ?  
 (1) Whimsical (2) Tragic  
 (3) Vicious (4) Uncanny  
 (SSC CPO Exam. 06.06.2016) (Ist Sitting)
- 364.** Select the related word from the given alternatives:  
 Pig : Sty :: Dog : ?  
 (1) Burrow (2) Hives  
 (3) Shed (4) Kennel  
 (SSC CHSL (10+2) Tier-I (CBE) Exam. 08.09.2016) (Ist Sitting)
- 365.** Select the related word from the given alternatives:  
 Magazine : Editor :: Drama : ?  
 (1) Director (2) Hero  
 (3) Heroine (4) Painter  
 (SSC CGL Tier-I (CBE) Exam. 09.09.2016) (Ist Sitting)
- Directions (366-367) :** In each of the following questions, select the related word from the given alternatives.
- (SSC CAPFs (CPO) SI & ASI, DP Exam. 20.03.2016) (IInd Sitting)
- 366.** heat : calorie :: sound : ?  
 (1) decibel (2) joule  
 (3) knot (4) richter

**ANALOGY OR SIMILARITY**

- 367.** brain : natural :: ? : artificial  
(1) deserts (2) forests  
(3) computers (4) minerals
- 368.** Select the related word from the given alternatives.  
Colour : Red :: Language : ?  
(1) Grammar (2) English  
(3) Lingual (4) History  
(SSC CAPFs (CPO) SI & ASI, Delhi Police  
Exam. 05.06.2016) (1st Sitting)
- 369.** Select the related word from the given alternatives.  
Baking : Bread :: ? : Curd  
(1) Brewing  
(2) Coagulation  
(3) Fermentation  
(4) Boiling  
(SSC CAPFs (CPO) SI & ASI, Delhi Police  
Exam. 05.06.2016) (1st Sitting)
- 370.** Select the related word from the given alternatives.  
Happy : Dismal :: Proud : ?  
(1) Eminent (2) Humble  
(3) Fiery (4) Gratified  
(SSC CPO SI & ASI, Online  
Exam. 06.06.2016) (IInd Sitting)
- 371.** Select the related word from the given alternatives.  
Powerful : Weak :: Victory : ?  
(1) Winning (2) Strong  
(3) Defeat (4) Peace  
(SSC CPO SI & ASI, Online  
Exam. 06.06.2016) (IInd Sitting)
- 372.** Select the related word from the given alternatives :  
College : Student :: Hospital : ?  
(1) Doctor (2) Treatment  
(3) Nurse (4) Patient  
(SSC CGL Tier-I (CBE)  
Exam. 27.08.2016) (1st Sitting)
- 373.** Select the related word from the given alternatives.  
Donkey : Brays :: Monkey : ?  
(1) Trumpets (2) Bellows  
(3) Chatters (4) Grunts  
(SSC CGL Tier-I (CBE)  
Exam. 27.08.2016) (IInd Sitting)
- 374.** Select the related word pair from the given alternatives.  
Head : Human Body :: ?  
(1) Arc : Circle  
(2) Cube : Circle  
(3) Square : Circle  
(4) Triangle : Circle  
(SSC CGL Tier-I (CBE)  
Exam. 28.08.2016) (IInd Sitting)
- 375.** Select the related word from the given alternatives.  
FUNGI: MYCOLOGY:: TISSUE: ?  
(1) Haematology (2) Cytology  
(3) Histology (4) Bacteriology  
(SSC CGL Tier-I (CBE)  
Exam. 29.08.2016) (IInd Sitting)
- 376.** Select the related word from the given alternatives :  
Flow : River :: Stagnant : ?  
(1) Pond (2) Rain  
(3) Stream (4) Canal  
(SSC CGL Tier-I (CBE)  
Exam. 30.08.2016) (1st Sitting)
- 377.** Select the related word from the given alternatives :  
CURE : DISEASE :: HEAL : ?  
(1) Illness (2) Injury  
(3) Recover (4) Sick  
(SSC CGL Tier-I (CBE)  
Exam. 31.08.2016) (1st Sitting)
- 378.** Select the related word from the given alternatives.  
Psychology : Human Being :: Ornithology : ?  
(1) Birds (2) Volcanoes  
(3) Insects (4) Reptiles  
(SSC CGL Tier-I (CBE)  
Exam. 01.09.2016) (1st Sitting)
- 379.** Select the related word from the given alternatives :  
Owl : Hoots :: Hen : ?  
(1) Chirps (2) Clucks  
(3) Coos (4) Cackles  
(SSC CGL Tier-I (CBE)  
Exam. 02.09.2016) (1st Sitting)
- 380.** Select the related word from the given alternatives.  
Apes : Gibber :: Camels : ?  
(1) grunt (2) cheep  
(3) bleat (4) whine  
(SSC CGL Tier-I (CBE)  
Exam. 02.09.2016) (IInd Sitting)
- 381.** Select the related word from the given alternatives.  
Cell : Cytology :: Birds : ?  
(1) Odontology (2) Mycology  
(3) Ornithology (4) Etymology  
(SSC CGL Tier-I (CBE)  
Exam. 03.09.2016) (IInd Sitting)
- 382.** Select the related word from the given alternatives :  
Play : Actor :: Concert  
(1) Symphony (2) Musician  
(3) Piano (4) Percussion  
(SSC CGL Tier-I (CBE)  
Exam. 04.09.2016) (1st Sitting)
- 383.** Select the related word from the given alternatives:  
Forecast : Future :: Regret : ?  
(1) Present (2) Sins  
(3) Life (4) Past  
(SSC CGL Tier-I (CBE)  
Exam. 06.09.2016) (1st Sitting)
- 384.** Select the related word from the given alternatives :  
Bacteria : Microscope :: Moon : ?  
(1) Night (2) Earth  
(3) Satellite (4) Telescope  
(SSC CGL Tier-I (CBE)  
Exam. 07.09.2016) (1st Sitting)
- 385.** Select the related word from the given alternatives.  
Earth : Planet :: Moon : ?  
(1) Sun (2) Universe  
(3) Venus (4) Satellite  
(SSC CGL Tier-I (CBE)  
Exam. 30.08.2016) (IInd Sitting)
- 386.** Select the related word from the given alternatives :  
Sanitation : Illness :: Care : ?  
(1) Rest (2) Ignore  
(3) Accident (4) Suggestion  
(SSC CGL Tier-I (CBE)  
Exam. 31.08.2016) (IInd Sitting)
- 387.** Select the related word from the given alternatives :  
Aviator : Aviates :: Senator : ?  
(1) Diagnosis (2) Legislates  
(3) Checks (4) Commands  
(SSC CGL Tier-I (CBE)  
Exam. 01.09.2016) (1st Sitting)
- 388.** Select the related word from the given alternatives :  
Peacock : India :: Bear : ?  
(1) Australia (2) America  
(3) England (4) Russia  
(SSC CGL Tier-I (CBE)  
Exam. 02.09.2016) (1st Sitting)
- 389.** Select the related word from the given alternatives :  
Electric Current : Ampere :: Weight : ?  
(1) Scale (2) Kilogram  
(3) Commodity  
(4) Measurement  
(SSC CGL Tier-I (CBE)  
Exam. 28.08.2016) (1st Sitting)
- 390.** Select the related word from the given alternatives :  
Foot : Man :: Hoof : ?  
(1) Leg (2) Dog  
(3) Horse (4) Shoe  
(SSC CGL Tier-I (CBE)  
Exam. 29.08.2016) (1st Sitting)

**ANALOGY OR SIMILARITY**

**391.** Select the related word from the given alternatives :

Grain : Warehouse :: Water : ?  
 (1) Canal (2) River  
 (3) Estuary (4) Dam

(SSC CGL Tier-I (CBE)  
 Exam. 30.08.2016) (IInd Sitting)

**392.** Select the related word from the given alternatives :

Coins : Mint :: Bricks : ?  
 (1) Kiln (2) Foundry  
 (3) Cementary (4) Finance

(SSC CGL Tier-I (CBE)  
 Exam. 31.08.2016) (IInd Sitting)

**393.** Select the related word from the given alternatives :

Book : Pages :: Wall : ?  
 (1) SAND (2) CEMENT  
 (3) BRICKS (4) STONES

(SSC CGL Tier-I (CBE)  
 Exam. 01.09.2016) (IInd Sitting)

**394.** Select the related word from the given alternatives :

Words : Sentence :: Paragraph : ?  
 (1) Typing (2) Essay  
 (3) Letters (4) Phrase

(SSC CGL Tier-I (CBE)  
 Exam. 02.09.2016) (IInd Sitting)

**395.** Select the related word from the given alternatives :

Paw : Cat :: Hoof : ?  
 (1) Man (2) Elephant  
 (3) Lion (4) Horse

(SSC CGL Tier-I (CBE)  
 Exam. 03.09.2016) (IIInd Sitting)

**396.** Select the related word from the given alternatives :

Jailor : Prison :: Curator : ?  
 (1) Cell (2) Museum  
 (3) Warden (4) Cure

(SSC CGL Tier-I (CBE)  
 Exam. 04.09.2016) (IIInd Sitting)

**397.** Select the related word pair from the given alternatives :

Preamble : Constitution :: ? : ?  
 (1) Word : Dictionary  
 (2) Contents : Magazine  
 (3) Explanation : Poetry  
 (4) Preface : Book

(SSC CGL Tier-I (CBE)  
 Exam. 06.09.2016) (IIInd Sitting)

**398.** Select the related word from the given alternatives :

Money : Poverty :: Education : ?  
 (1) Knowledge (2) Greediness  
 (3) Illiteracy (4) Unsuccess

(SSC CGL Tier-I (CBE)  
 Exam. 07.09.2016) (IIInd Sitting)

**399.** Select the related word from the given alternatives :

Air : Bird :: Water : ?  
 (1) Fish (2) Swim  
 (3) Wash (4) Drink

(SSC CGL Tier-I (CBE)  
 Exam. 08.09.2016) (IIInd Sitting)

**400.** Select the related word from the given alternatives :

Star : Telescope :: Ship : ?  
 (1) Periscope (2) Microscope  
 (3) Deck (4) Gyroscope

(SSC CGL Tier-I (CBE)  
 Exam. 09.09.2016) (IIInd Sitting)

**401.** Select the related word from the given alternatives :

Line : Square :: Arc : ?  
 (1) Ring (2) Sphere  
 (3) Circle (4) Ball

(SSC CGL Tier-I (CBE)  
 Exam. 10.09.2016) (IIInd Sitting)

**402.** Select the related word from the given alternatives :

Accommodation : Rent :: Journey : ?  
 (1) Expense (2) Octroi  
 (3) Freight (4) Fare

(SSC CGL Tier-I (CBE)  
 Exam. 03.09.2016) (IInd Sitting)

**403.** Select the related word from the given alternatives :

Summer : Aestivation :: Winter : ?  
 (1) Cache (2) Hibernation  
 (3) Survival (4) Activation

(SSC CGL Tier-I (CBE)  
 Exam. 04.09.2016) (IInd Sitting)

**404.** Select the related word from the given alternatives :

Calender : Dates :: Dictionary : ?  
 (1) Words (2) Books  
 (3) Language (4) Vocabulary

(SSC CGL Tier-I (CBE)  
 Exam. 06.09.2016) (IInd Sitting)

**405.** Select the related word-pair from the given alternatives :

Pesticide : Plant :: ? : ?  
 (1) Medicine : Cure  
 (2) Injection : Fever  
 (3) Vaccination : Baby  
 (4) Sinarest : Cold

(SSC CGL Tier-I (CBE)  
 Exam. 07.09.2016) (IInd Sitting)

**406.** Select the related word from the given alternatives :

FINGERS : HAND :: ? : FEET  
 (1) NAILS (2) TOES  
 (3) ANKLE (4) HEELS

(SSC CGL Tier-I (CBE)  
 Exam. 08.09.2016) (IInd Sitting)

**407.** Select the related word from the given alternatives :

Length : Metre :: Power : ?  
 (1) Calories (2) Degree  
 (3) Watt (4) Kilogram

(SSC CGL Tier-I (CBE)  
 Exam. 09.09.2016) (IInd Sitting)

**408.** Select the related word from the given alternatives :

Dark : Light :: Noise : ?  
 (1) Music (2) Quiet  
 (3) Melody (4) Vacuum

(SSC CGL Tier-I (CBE)  
 Exam. 10.09.2016) (IInd Sitting)

**409.** Select the related word from the given alternatives:

Medicine : Patient :: Education : ?  
 (1) Teacher (2) School  
 (3) Student (4) Tuition

(SSC CGL Tier-I (CBE)  
 Exam. 11.09.2016) (Ist Sitting)

**410.** Select the related word from the given alternatives.

Maharashtra : India :: Texas : ?  
 (1) Canada (2) Mexico  
 (3) Brazil (4) USA

(SSC CGL Tier-I (CBE)  
 Exam. 11.09.2016) (IInd Sitting)

**411.** Select the related word from the given alternatives.

Currency : Yen :: Nationality : ?  
 (1) Person (2) Nation  
 (3) Indian (4) Patriotism

(SSC CGL Tier-I (CBE)  
 Exam. 27.10.2016) (Ist Sitting)

**412.** Select the related word from the given alternatives.

Yesterday : Tomorrow :: March : ?  
 (1) April (2) May  
 (3) January (4) June

(SSC CGL Tier-I (CBE)  
 Exam. 27.10.2016) (IInd Sitting)

**413.** Select the related word from the given alternatives :

Iron Man of India : Sardar Vallabhbhai Patel :: Father of the Nation : ?

(1) Lokmanya Tilak  
 (2) Rajeev Gandhi  
 (3) Jawahar Lal Nehru  
 (4) Mahatma Gandhi

(SSC CHSL (10+2) Tier-I (CBE)  
 Exam. 15.01.2017) (IInd Sitting)

**414.** Select the related letters from the given alternatives :

THUNDER : UHTNRED :: THIEVES : ?

**ANALOGY OR SIMILARITY**

- (1) ITHESEV (2) IHTEESV  
(3) IHTESEV (4) IHTSEVE  
(SSC CHSL (10+2) Tier-I (CBE)  
Exam. 15.01.2017) (IInd Sitting)

**415.** Select the related word from the given alternatives :

Goal : Football :: Basket : ?

- (1) Polo (2) Cricket  
(3) Volleyball (4) Basketball

(SSC CHSL (10+2) Tier-I (CBE)  
Exam. 16.01.2017) (IInd Sitting)

**Directions (416–417) :** Select the related word from the given alternatives.

(SSC Multi-Tasking Staff  
Exam. 30.04.2017 1st Sitting)

**416.** Cricket : Pitch :: ? : ?

- (1) Boat : Harbour  
(2) Wrestling : Track  
(3) Boxing : Ring  
(4) Ship : Dock

**417.** Nose : Face :: Finger : ?

- (1) Palm (2) Body  
(3) Arm (4) Hand

**TYPE-II**

**Directions :** From among the given alternatives select the one in which the set of numbers is most like the set of numbers given in the question.

**1. Given set :** (3, 7, 15)

- (1) 2, 6, 10 (2) 4, 8, 18  
(3) 5, 9, 17 (4) 7, 12, 19

(SSC Combined Graduate Level Prelim  
Exam. 24.02.2002 (1st Sitting))

**2. Given set :** (3, 18, 36)

- (1) (2, 10, 16) (2) (12, 72, 96)  
(3) (4, 24, 48) (4) (6, 42, 48)

(SSC Combined Graduate Level Prelim  
Exam. 24.02.2002 (1st Sitting))

**3. Given Set :** (7, 15, 31)

- (1) 7, 13, 28 (2) 5, 13, 28  
(3) 9, 13, 26 (4) 5, 13, 29

(SSC Combined Graduate Level Prelim  
Exam. 24.02.2002 (Middle Zone))

**4. Given set :** 63, 49, 35

- (1) 81, 63, 45 (2) 64, 40, 28  
(3) 72, 40, 24 (4) 72, 48, 24

(SSC CPO Sub-Inspector  
Exam.12.01.2003)

**5. Given set :** (2, 14, 16)

- (1) 2, 7, 8 (2) 3, 21, 24  
(3) 4, 16, 18 (4) 2, 9, 16

(SSC Combined Graduate Level Prelim  
Exam. 11.05.2003 (1st Sitting))

**6. Given number set : (6, 36, 63)**

- (1) 7, 49, 98 (2) 8, 64, 46  
(3) 9, 84, 45 (4) 11, 111, 84

(SSC Combined Graduate Level Prelim  
Exam.11.05.2003 (IInd Sitting))

**7. Given set :** (4, 10, 15)

- (1) (3, 6, 12) (2) (2, 8, 10)  
(3) (5, 12, 18) (4) (7, 10, 18)

(SSC Combined Graduate Level Prelim  
Exam. 08.02.2004 (1st Sitting))

**8. Given set :** (32, 24, 8),

- (1) (42, 34, 16) (2) (24, 16, 0)  
(3) (34, 24, 14) (4) (26, 32, 42)

(SSC Combined Graduate Level Prelim  
Exam. 13.11.2005 (1st Sitting))

**9. Given set :** (5, 9, 16)

- (1) (4, 8, 16) (2) (6, 9, 12)  
(3) (7, 11, 18) (4) (8, 11, 12)

(SSC Combined Graduate Level Prelim  
Exam. 13.11.2005 (IInd Sitting))

**10. Given set :** 23, 51, 17

- (1) 29, 57, 13 (2) 24, 53, 17  
(3) 29, 57, 14 (4) 21, 51, 17

(SSC CPO Sub-Inspector  
Exam. 03.09.2006)

**11. Given set :** (2, 10, 58)

- (1) (4, 20, 56) (2) (7, 42, 49)  
(3) (12, 24, 47) (4) (9, 27, 81)

(SSC Combined Graduate Level Prelim  
Exam. 04.02.2007 (IInd Sitting))

**12. Given set :** (3, 4, 5)

- (1) (6, 8, 10) (2) (9, 12, 15)  
(3) (6, 7, 8) (4) (12, 16, 20)

(SSC Combined Graduate Level Prelim  
Exam. 27.07.2008 (1st Sitting))

**13. Given set :** (17, 13, 20)

- (1) 8, 12, 19 (2) 11, 9, 30  
(3) 8, 19, 11 (4) 5, 13, 11

(SSC Combined Graduate Level Prelim  
Exam. 27.07.2008 (1st Sitting))

**14. Given :** (6, 30, 90)

- (1) 6, 42, 86 (2) 7, 42, 218  
(3) 6, 24, 70 (4) 8, 48, 192

(SSC CPO Sub-Inspector  
Exam. 06.09.2009)

**15. Given set :** (6, 14, 30)

- (1) 4, 16, 28 (2) 7, 12, 22  
(3) 6, 12, 22 (4) 5, 12, 20

(SSC Combined Graduate Level Tier-1  
Exam.16.05.2010 (IInd Sitting))

**16. Given set :** (7, 12, 22, 37)

- (1) 2, 7, 12, 32 (2) 3, 8, 18, 33  
(3) 4, 8, 19, 34 (4) 8, 13, 22, 38

(SSC SAS Exam. 26.06.2010 (Paper-I))

**17. Given set :** (10.5, 15.0, 21.5)

- (1) (32.5, 37.0, 43.5)  
(2) (54.4, 58.0, 62.4)  
(3) (62.2, 66.8, 73.3)  
(4) (81.3, 85.8, 92.0)

(SSC CISF ASI Exam. 29.08.2010  
(Paper-I))

**18. Given set :** (2, 10, 28)

- (1) (4, 20, 56) (2) (7, 42, 49)  
(3) (12, 24, 48) (4) (9, 27, 81)

(SSC CPO Sub-Inspector  
Exam.12.12.2010 (Paper-I))

**19. Give Set :** (4, 25, 81)

- (1) (4, 36, 79) (2) (9, 48, 81)  
(3) (16, 64, 100) (4) (9, 49, 143)

(SSC Combined Graduate Level Prelim  
Exam. 19.06.2011 (IInd Sitting))

**20. Given Set :** (8, 56, 72)

- (1) (7, 56, 63) (2) (3, 15, 24)  
(3) (6, 42, 54) (4) (5, 30, 35)

(SSC Combined Graduate Level Tier-1  
Exam. 26.06.2011 (IInd Sitting))

**21. Given Set :** (4, 9, 25)

- (1) 4, 25, 36, (2) 9, 16, 25  
(3) 4, 16, 36 (4) 9, 25, 49

(SSC Combined Matric Level (PRE)  
Exam.21.05.2000 (1st Sitting  
(Raipur, Madhya Pradesh))

**22. Given Set :** (5, 15, 40)

- (1) 2, 4, 15 (2) 3, 18, 36  
(3) 7, 15, 21 (4) 9, 36, 47

(SSC Combined Matric Level (PRE)  
Exam. 21.05.2000 (1st Sitting  
(Middle Zone))

**23. Given set:** (9, 81, 729)

- (1) (3, 9, 30)  
(2) (7, 49, 343)  
(3) (12, 144, 221)  
(4) (6, 36, 92)

(SSC Combined Matric Level (PRE)  
Exam. 05.05.2002 (1st Sitting)  
(Eastern Zone, Guwahati))

**24. Given set :** 27, 22, 18, 15

- (1) 27, 23, 17, 9  
(2) 53, 49, 47, 45  
(3) 47, 43, 37, 35  
(4) 31, 26, 22, 19

(SSC Combined Matric Level (PRE)  
Exam. 05.05.2002 (IInd Sitting)  
(Eastern Zone, Guwahati))

**25. Given set :** (1, 4, 9)?

- (1) (3, 8, 20) (2) (5, 10, 22)  
(3) (4, 10, 15) (4) (9, 16, 25)

(SSC Combined Matric Level (PRE)  
Exam. 05.05.2002 (IInd Sitting)  
(Eastern Zone, Guwahati))

**ANALOGY OR SIMILARITY**

- 26. Given set :** (1, 8, 27)  
 (1) (5, 12, 32)  
 (2) (32, 39, 59)  
 (3) (60, 79, 86)  
 (4) (64, 125, 216)  
 (SSC Combined Matric Level (PRE)  
 Exam.05.05.2002 (1st Sitting  
 (North Zone, Delhi)
- 27. Given set :** (21, 18, 12, 0)  
 (1) 36, 32, 28, 30  
 (2) 24, 22, 18, 9  
 (3) 32, 28, 20, 4  
 (4) 40, 38, 36, 28  
 (SSC Combined Matric Level (PRE)  
 Exam.05.05.2002 (1st Sitting  
 (North Zone, Delhi)
- 28. Select the pair which resembles the given set of numbers: 16, 36, 64**  
 (1) 4, 9, 144  
 (2) 16, 100, 256  
 (3) 25, 49, 121  
 (4) 9, 81, 169  
 SSC Combined Matric Level (Pre) Exam.  
 12.05.2002 (1st Sitting)
- 29. Given set :** (64, 216, 125)  
 (1) 26, 144, 163  
 (2) 55, 126, 80  
 (3) 8, 27, 64  
 (4) 45, 134, 154  
 SSC Combined Matric Level (Pre) Exam.  
 12.05.2002 (IInd Sitting)
- 30. Given set of numbers :** (2, 5, 15)  
 (1) (7, 10, 13) (2) (3, 8, 24)  
 (3) (3, 6, 18) (4) (4, 5, 9)  
 SSC Combined Matric Level (Pre)  
 Exam.16.06.2002 (Re-Exam)
- 31. Given set is :** (12, 18, 24)  
 (1) (6, 12, 30) (2) (5, 15, 10)  
 (3) (10, 16, 18) (4) (8, 12, 16)  
 (SSC Higher Secondary Level  
 Data Entry Operator & LDC  
 Exam.27.11.2010)
- 32. Given set is :** (12, 20, 28)  
 (1) (3, 15, 18) (2) (18, 27, 72)  
 (3) (18, 30, 42) (4) (7, 14, 28)  
 (SSC Higher Secondary Level  
 Data Entry Operator & LDC  
 Exam.27.11.2010)
- 33. Given set :** (10, 12, 15)  
 (1) (21, 23, 27) (2) (30, 32, 36)  
 (3) (60, 62, 66) (4) (68, 70, 73)  
 (SSC Higher Secondary Level  
 Data Entry Operator & LDC  
 Exam. 28.11.2010 (IInd sitting)

- 34. Given set :** (14, 20, 3)  
 (1) (7, 13, 3) (2) (5, 10, 15)  
 (3) (3, 6, 9) (4) (4, 8, 16)  
 (SSC Stenographer Grade 'C' & 'D'  
 Exam. 09.01.2011)
- 35. The set which resembles the given set 1, 5, 12 is**  
 (1) 7, 11, 35 (2) 4, 8, 24  
 (3) 10, 14, 44 (4) 9, 13, 42  
 (SSC Graduate Level Tier-I  
 Exam. 19.05.2013, IInd Sitting)
- Directions (36-37) :** In each of the following questions, choose the numbers similar to the group of numbers given.  
 (SSC CHSL (10+2) DEO & LDC  
 Exam. 16.11.2014)
- 36. 580, 265, 373**  
 (1) 366 (2) 490  
 (3) 428 (4) 383
- 37. 536, 428, 365**  
 (1) 358 (2) 435  
 (3) 624 (4) 266
- 38. Choose the similar group of numbers on the basis of certain common properties they possess :**  
 (31, 19, 41)  
 (1) (16, 27, 11)(2) (23, 33, 51)  
 (3) (27, 29, 47)(4) (29, 17, 37)  
 (SSC CAPFs SI, CISF ASI & Delhi  
 Police SI Exam, 21.06.2015  
 (1st Sitting) TF No. 8037731)
- 39. Choose the similar group of numbers on the basis of certain common properties they possess :**  
 (72, 66, 96)  
 (1) (54, 57, 78)  
 (2) (24, 69, 58)  
 (3) (55, 66, 77)  
 (4) (63, 70, 86)  
 (SSC CHSL (10+2) LDC, DEO  
 & PA/SA Exam, 15.11.2015  
 (IInd Sitting) TF No. 7203752)
- 40. Find out the set of numbers amongst the four sets of numbers given in the alternatives which is most like the set given in the question.**  
 (12, 24, 144)  
 (1) (10, 25, 100)  
 (2) (15, 45, 90)  
 (3) (14, 28, 112)  
 (4) (13, 26, 169)  
 (SSC CHSL (10+2) LDC, DEO  
 & PA/SA Exam, 06.12.2015  
 (IInd Sitting) TF No. 3441135)

**TYPE-III**

**Directions :** In each of the following questions, select the related number from the given alternatives.

- 1. 3 : 243 :: 5 : ?**  
 (1) 405 (2) 465  
 (3) 3125 (4) 546  
 (SSC Combined Graduate Level Prelim  
 Exam. 04.07.1999 (1st Sitting)
- 2. 6 : 18 :: 4 : ?**  
 (1) 2 (2) 6  
 (3) 9 (4) 16  
 (SSC Combined Graduate Level Prelim  
 Exam. 04.07.1999 (1st Sitting)
- 3. 5 : 36 :: 6 : ?**  
 (1) 48 (2) 50  
 (3) 49 (4) 56  
 (SSC Combined Graduate Level Prelim  
 Exam. 04.07.1999 (IInd Sitting)
- 4. 456 : 15 :: 789 : ?**  
 (1) 15 (2) 16  
 (3) 18 (4) 24  
 (SSC Combined Graduate Level Prelim  
 Exam. 04.07.1999 (IInd Sitting)
- 5. 182 : ? :: 210 : 380**  
 (1) 342 (2) 272  
 (3) 240 (4) 156  
 (SSC Combined Graduate Level Prelim  
 Exam. 27.02.2000 (1st Sitting)
- 6. 18 : 30 :: 36 : ?**  
 (1) 64 (2) 66  
 (3) 54 (4) 62  
 (SSC Combined Graduate Level Prelim  
 Exam. 24.02.2002 (1st Sitting)
- 7. 0.16 : 0.0016 :: 1.02 : ?**  
 (1) 10.20 (2) 0.102  
 (3) 0.0102 (4) 1.020  
 (SSC Combined Graduate Level Prelim  
 Exam. 24.02.2002 (1st Sitting)
- 8. 68 : 130 :: ? : 350**  
 (1) 240 (2) 222  
 (3) 216 (4) 210  
 (SSC Combined Graduate Level Prelim  
 Exam. 24.02.2002 (IInd Sitting)
- 9. 48 : 122 :: 168 : ?**  
 (1) 292 (2) 290  
 (3) 225 (4) 215  
 (SSC Combined Graduate Level Prelim  
 Exam. 24.02.2002 (IInd Sitting)
- 10. 169 : 13 :: 289 : ?**  
 (1) 19 (2) 17  
 (3) 27 (4) 23  
 (SSC Combined Graduate Level Prelim  
 Exam. 24.02.2002 (Middle Zone)

**ANALOGY OR SIMILARITY**

- 11.** 122 : 170 :: 290 : ?  
 (1) 362 (2) 299  
 (3) 315 (4) 341  
 (SSC Combined Graduate Level Prelim Exam. 24.02.2002 (Middle Zone))
- 12.** 42 : 56 :: 72 : ?  
 (1) 81 (2) 90  
 (3) 92 (4) 100  
 (SSC CPO Sub-Inspector Exam. 12.01.2003)
- 13.** 3265 : 4376 :: 4673 : ?  
 (1) 2154 (2) 5487  
 (3) 3562 (4) 5784  
 (SSC CPO Sub-Inspector Exam. 12.01.2003)
- 14.** 24 : 60 :: 210 : ?  
 (1) 504 (2) 343  
 (3) 336 (4) 330  
 (SSC Combined Graduate Level Prelim Exam. 11.05.2003 (Ist Sitting))
- 15.** 6 : 222 :: 7 : ?  
 (1) 350 (2) 343  
 (3) 336 (4) 210  
 (SSC Combined Graduate Level Prelim Exam. 11.05.2003 (IInd Sitting))
- 16.** 5 : 124 :: 7 : ?  
 (1) 342 (2) 343  
 (3) 248 (4) 125  
 (SSC CPO Sub-Inspector Exam. 07.09.2003)
- 17.** 19 : 37 :: 26 : ?  
 (1) 52 (2) 51  
 (3) 46 (4) 43  
 (SSC Combined Graduate Level Prelim Exam. 08.02.2004 (Ist Sitting))
- 18.** 24 : 60 :: 120 : ?  
 (1) 160 (2) 220  
 (3) 300 (4) 108  
 (SSC Combined Graduate Level Prelim Exam. 08.02.2004 (IInd Sitting))
- 19.** 7 : 50 :: 11 : ?  
 (1) 100 (2) 120  
 (3) 128 (4) 122  
 (SSC CPO Sub-Inspector Exam. 05.09.2004)
- 20.** 7584 : 5362 :: 4673 : ?  
 (1) 2367 (2) 2451  
 (3) 2531 (4) 2485  
 (SSC CPO Sub-Inspector Exam. 05.09.2004)
- 21.** 5 : 36 :: 6 : ?  
 (1) 48 (2) 50  
 (3) 49 (4) 56  
 (SSC CPO Sub-Inspector Exam. 26.05.2005)
- 22.** 182 : ? :: 210 : 380  
 (1) 342 (2) 272  
 (3) 240 (4) 156  
 (SSC CPO Sub-Inspector Exam. 26.05.2005)
- 23.** 25 : 37 :: 49 : ?  
 (1) 41 (2) 65  
 (3) 56 (4) 60  
 (SSC Statistical Investigators Grade-IV Exam. 31.07.2005)
- 24.** 16 : 56 :: 32 : ?  
 (1) 96 (2) 112  
 (3) 120 (4) 128  
 (SSC Combined Graduate Level Prelim Exam. 13.11.2005 (Ist Sitting))
- 25.** 45 : 36 :: 63 : ?  
 (1) 71 (2) 54  
 (3) 61 (4) 64  
 (SSC Combined Graduate Level Prelim Exam. 13.11.2005 (IInd Sitting))
- 26.** 42 : 56 :: 110 : ?  
 (1) 132 (2) 136  
 (3) 140 (4) 18  
 (SSC CPO Sub-Inspector Exam. 03.09.2006)
- 27.** 5 : 100, 4 : 64 :: 4 : 80, 3 : ?  
 (1) 26 (2) 48  
 (3) 60 (4) 54  
 (SSC CPO Sub-Inspector Exam. 03.09.2006)
- 28.** 42 : 56 :: 132 : ?  
 (1) 156 (2) 145  
 (3) 110 (4) 240  
 (SSC Combined Graduate Level Prelim Exam. 04.02.2007 (Ist Sitting))
- 29.** 11:121 : 110 :: 15 : 225 : 210 :: ?  
 (1) 9 : 81 : 70  
 (2) 19 : 361 : 342  
 (3) 17 : 288 : 272  
 (4) 16 : 255 : 239  
 (SSC Combined Graduate Level Prelim Exam. 04.02.2007 (Ist Sitting))
- 30.** 122 : 145 :: 226 : ?  
 (1) 250 (2) 256  
 (3) 257 (4) 290  
 (SSC Combined Graduate Level Prelim Exam. 04.02.2007 (IInd Sitting))
- 31.** 2:4:8 : 10:20:40 :: 3:6:9 : ?  
 (1) 18:27:54 (2) 5:10:17  
 (3) 6:24:56 (4) 15:30:45  
 (SSC Combined Graduate Level Prelim Exam. 04.02.2007 (IInd Sitting))
- 32.** 5 : 21 :: 7 : ?  
 (1) 25 (2) 49  
 (3) 43 (4) 30  
 (SSC CPO Sub-Inspector Exam. 16.12.2007)
- 33.** 4 : 12 :: 5 : ?  
 (1) 25 (2) 20  
 (3) 22 (4) 30  
 (SSC CPO Sub-Inspector Exam. 16.12.2007)
- 34.** 01 : 36 :: 2 : ?  
 (1) 69 (2) 49  
 (3) 81 (4) 70  
 (SSC Combined Graduate Level Prelim Exam. 27.07.2008 (Ist Sitting))
- 35.** 136 : 469 :: 247 : ?  
 (1) 137 (2) 358  
 (3) 368 (4) 146  
 (SSC Combined Graduate Level Prelim Exam. 27.07.2008 (Ist Sitting))
- 36.** 49 : 81 :: 64 : ?  
 (1) 36 (2) 100  
 (3) 121 (4) 144  
 (SSC Combined Graduate Level Prelim Exam. 27.07.2008 (IInd Sitting))
- 37.** 371 : 150 :: 468 : ?  
 (1) 247 (2) 357  
 (3) 246 (4) 345  
 (SSC Combined Graduate Level Prelim Exam. 27.07.2008 (IInd Sitting))
- 38.** 42 : 31 :: ?  
 (1) 97 : 86 (2) 53 : 46  
 (3) 79 : 86 (4) 64 : 79  
 (SSC Combined Graduate Level Prelim Exam. 27.07.2008 (IInd Sitting))
- 39.** 7 : 17 :: ? : 50  
 (1) 23 (2) 26  
 (3) 124 (4) 126  
 (SSC CPO Sub-Inspector Exam. 09.11.2008)
- 40.** 1648 : 1339 :: 2266 : ?  
 (1) 1234 (2) 2133  
 (3) 1442 (4) 1551  
 (SSC CPO Sub-Inspector Exam. 09.11.2008)
- 41.** 7 : ? :: 145 : 195  
 (1) 42 (2) 35  
 (3) 30 (4) 24  
 (SSC CPO Sub-Inspector Exam. 06.09.2009)
- 42.** 3222 : 7222 :: 3323 : ?  
 (1) 9949 (2) 8838  
 (3) 7727 (4) 2212  
 (SSC CPO Sub-Inspector Exam. 06.09.2009)
- 43.** 1 : 8 :: 27 : ?  
 (1) 37 (2) 47  
 (3) 57 (4) 64  
 (SSC Combined Graduate Level Tier-1 Exam. 16.05.2010 (IInd Sitting))

**ANALOGY OR SIMILARITY**

- 44.** 24 : 126 :: 48 : ?  
 (1) 433 (2) 192  
 (3) 240 (4) 344  
 (SSC Combined Graduate Level Tier-1 Exam.16.05.2010 (IInd Sitting))
- 45.** 2 : 7 :: 6 : ?  
 (1) 40 (2) 39  
 (3) 50 (4) 72  
 (SSC SAS Exam. 26.06.2010 (Paper-I))
- 46.** 24 : 27 = ? : 81  
 (1) 8 (2) 62  
 (3) 72 (4) 82  
 (SSC SAS Exam. 26.06.2010 (Paper-I))
- 47.** 47 : 65 :: 59 : ?  
 (1) 95 (2) 110  
 (3) 106 (4) 118  
 (SSC SAS Exam. 26.06.2010 (Paper-I))
- 48.** 20 : 30 :: ? : 72  
 (1) 56 (2) 59  
 (3) 68 (4) 61  
 (SSC CISF ASI Exam. 29.08.2010 (Paper-I))
- 49.** 342 : 453 :: 831 : ?  
 (1) 942 (2) 720  
 (3) 922 (4) 740  
 (SSC CISF ASI Exam. 29.08.2010 (Paper-I))
- 50.** 30 : 130 :: ? : ?  
 (1) 20 : 120 (2) 37 : 210  
 (3) 42 : 222 (4) 49 : 350  
 (SSC CISF ASI Exam. 29.08.2010 (Paper-I))
- 51.** 520 : 738 :: ? : 350  
 (1) 220 (2) 222  
 (3) 230 (4) 248  
 (SSC CPO Sub-Inspector Exam.12.12.2010 (Paper-I))
- 52.** 423 : 657 :: 534 : ?  
 (1) 678 (2) 867  
 (3) 768 (4) 876  
 (SSC CPO Sub-Inspector Exam.12.12.2010 (Paper-I))
- 53.** 13 : 24 :: ? : ?  
 (1) 45 : 79 (2) 56 : 78  
 (3) 35 : 59 (4) 57 : 68  
 (SSC CPO Sub-Inspector Exam.12.12.2010 (Paper-I))
- 54.** 24 : 60 :: 120 : ?  
 (1) 160 (2) 220  
 (3) 300 (4) 108  
 (SSC Combined Graduate Level Prelim Exam.19.06.2011 (Ist Sitting))
- 55.** 392 : 28 :: 722 : ?  
 (1) 18 (2) 28  
 (3) 38 (4) 48  
 (SSC Combined Graduate Level Prelim Exam.19.06.2011 (Ist Sitting))
- 56.** 123 : 36 :: 221 : ?  
 (1) 52 (2) 69  
 (3) 72 (4) 25  
 (SSC Combined Graduate Level Prelim Exam.19.06.2011 (Ist Sitting))
- 57.** 6 : 5 :: 8 : ?  
 (1) 2 (2) 4  
 (3) 6 (4) 10  
 (SSC Combined Graduate Level Prelim Exam. 19.06.2011(IInd Sitting))
- 58.** ? : 63 :: 08 : 26  
 (1) 12 (2) 9  
 (3) 18 (4) 15  
 (SSC Combined Graduate Level Prelim Exam. 19.06.2011(IInd Sitting))
- 59.** 64 : ? :: 72 : 53  
 (1) 44 (2) 54  
 (3) 52 (4) 70  
 (SSC Combined Graduate Level Prelim Exam. 19.06.2011 (IInd Sitting))
- 60.** 17 % 60 :: 20 : ?  
 (1) 57 (2) 69  
 (3) 81 (4) 93  
 (SSC Combined Graduate Level Tier-1 Exam. 26.06.2011 (Ist Sitting))
- 61.** 6 : 64 :: 11 : ?  
 (1) 144 (2) 169  
 (3) 121 (4) 124  
 (SSC Combined Graduate Level Tier-1 Exam. 26.06.2011 (Ist Sitting))
- 62.** 123 : 4 :: 726 : ?  
 (1) 23 (2) 26  
 (3) 14 (4) 12  
 (SSC Combined Graduate Level Tier-1 Exam. 26.06.2011 (Ist Sitting))
- 63.** 83 : 25 :: 29 : ?  
 (1) 44 (2) 49  
 (3) 40 (4) 63  
 (SSC Combined Graduate Level Tier-1 Exam. 26.06.2011 (IInd Sitting))
- 64.** 1 : 6 :: 8 : ?  
 (1) 11 (2) 13  
 (3) 12 (4) 14  
 (SSC CPO (SI, ASIn& Intelligence Officer) Exam. 28.08.2011 (Paper-I))
- 65.** 3, 1, 2, 2, : 9, 1, 4, 4 :: 0, 2, 3, 3, : ?  
 (1) 1, 4, 6, 6 (2) 1, 4, 9, 9  
 (3) 0, 4, 6, 6 (4) 0, 4, 9, 9  
 (SSC Combined Matric Level (PRE) Exam.24.10.1999 (Ist Sitting))
- 66.** 5.5 : 30.25 :: 11.0 : ?  
 (1) 22.0 (2) 66.0  
 (3) 55.00 (4) 121.00  
 (SSC Combined Matric Level (PRE) Exam.24.10.1999 (Ist Sitting))
- 67.** 8 : 20 :: 14 : ?  
 (1) 35 (2) 30  
 (3) 28 (4) 20  
 (SSC Combined Matric Level (PRE) Exam.24.10.1999 (Ist Sitting))
- 68.** 3 : 27 :: 5 : ?  
 (1) 9 (2) 125  
 (3) 29 (4) 51  
 (SSC Combined Matric Level (PRE) Exam.24.10.1999 (Ist Sitting))
- 69.** 1234 : 4132 :: 5678 : ?  
 (1) 8765 (2) 8576  
 (3) 8675 (4) 8567  
 (SSC Combined Matric Level (PRE) Exam.24.10.1999 (IInd Sitting))
- 70.** 763 : 856 :: 637 : ?  
 (1) 866 (2) 730  
 (3) 737 (4) 637  
 (SSC Combined Matric Level (PRE) Exam.24.10.1999 (IInd Sitting))
- 71.** 36 : 324 :: 49 : ?  
 (1) 441 (2) 411  
 (3) 4144 (4) 444  
 (SSC Combined Matric Level (PRE) Exam.24.10.1999 (IInd Sitting))
- 72.** 49 : 81 :: 64 : ?  
 (1) 36 (2) 100  
 (3) 121 (4) 144  
 (SSC Combined Matric Level (PRE) Exam.24.10.1999 (IInd Sitting))
- 73.** 27 : 9 :: 64 : ?  
 (1) 8 (2) 12  
 (3) 16 (4) 20  
 (SSC Combined Matric Level (PRE) Exam.21.05.2000 (Ist Sitting) (Raipur, Madhya Pradesh))
- 74.** 9 : 80 :: 100 : ?  
 (1) 901 (2) 1009  
 (3) 9999 (4) 10999  
 (SSC Combined Matric Level (PRE) Exam.21.05.2000 (Ist Sitting) (Raipur, Madhya Pradesh))
- 75.** 11 : 38 :: 13 : ?  
 (1) 47 (2) 44  
 (3) 43 (4) 46  
 (SSC Combined Matric Level (PRE) Exam. 21.05.2000 (Ist Sitting) (Middle Zone))
- 76.** 3 : 18 :: 13 : ?  
 (1) 48 (2) 78  
 (3) 24 (4) 26  
 (SSC Combined Matric Level (PRE) Exam. 21.05.2000 (Ist Sitting) (Middle Zone))
- 77.** 10 : 099 :: 09 : ?  
 (1) 49 (2) 80  
 (3) 69 (4) 79  
 (SSC Combined Matric Level (PRE) Exam.13.05.2001 (Ist Sitting))

**ANALOGY OR SIMILARITY**

- 78.** 37 : 23 :: 19 : ?  
 (1) 9 (2) 5  
 (3) 6 (4) 8  
 (SSC Combined Matric Level (PRE)  
 Exam.13.05.2001 (IInd Sitting))
- 79.** 13 : 5 :: 32 : ?  
 (1) 24 (2) 37  
 (3) 45 (4) 56  
 (SSC Combined Matric Level (PRE)  
 Exam. 27.05.2001 (IInd Sitting  
 (East Zone))
- 80.** 8 : 24 :: ? : 32  
 (1) 5 (2) 6  
 (3) 8 (4) 10  
 (SSC Combined Matric Level (PRE)  
 Exam. 05.05.2002 (Ist Sitting)  
 (Eastern Zone, Guwahati))
- 81.** 76 : 83 :: 42 : ?  
 (1) 34 (2) 21  
 (3) 12 (4) 7  
 (SSC Combined Matric Level (PRE)  
 Exam. 05.05.2002 (IInd Sitting)  
 (Eastern Zone, Guwahati))
- 82.** 149 : 238 :: 159 : ?  
 (1) 248 (2) 261  
 (3) 169 (4) 268  
 (SSC Combined Matric Level (PRE)  
 Exam.05.05.2002 (Ist Sitting  
 (North Zone, Delhi))
- 83.** 63 : 9 :: ? : 14  
 (1) 68 (2) 42  
 (3) 96 (4) 56  
 SSC Combined Matric Level (Pre) Exam.  
 05.05.2002 (IInd Sitting)  
 (North Zone Delhi)
- 84.** 5 : 2431 :: 8 : ?  
 (1) 4287 (2) 5461  
 (3) 7624 (4) 6743  
 SSC Combined Matric Level (Pre)  
 Exam. 12.05.2002 (Ist Sitting)
- 85.** 49 : 81 :: 100 : ?  
 (1) 64 (2) 144  
 (3) 169 (4) None of these  
 SSC Combined Matric Level (Pre)  
 Exam. 12.05.2002 (IInd Sitting)
- 86.** 4 : 19 :: 7 : ?  
 (1) 49 (2) 52  
 (3) 28 (4) 68  
 SSC Combined Matric Level (Pre)  
 Exam.16.06.2002 (Re-Exam)
- 87.** 123 : 13<sup>2</sup> :: 235 : ?  
 (1) 23<sup>5</sup> (2) 25<sup>3</sup>  
 (3) 35<sup>2</sup> (4) 25<sup>2</sup>  
 SSC Combined Matric Level (Pre)  
 Exam.16.06.2002 (Re-Exam)
- 88.** 27 : 125 :: 64 : ?  
 (1) 517 (2) 62  
 (3) 216 (4) 273  
 SSC Combined Matric Level (Pre)  
 Exam.16.06.2002 (Re-Exam)
- 89.** 10 : 99 :: 9 : ?  
 (1) 49 (2) 80  
 (3) 69 (4) 97  
 SSC Combined Matric Level (Pre)  
 Exam.16.06.2002 (Re-Exam)
- 90.** 11 : 5 :: 17 : ?  
 (1) 6 (2) 8  
 (3) 10 (4) 12  
 SSC Combined Matric Level (Pre)  
 Exam.30.07.2006 (Ist Sitting)  
 (East Zone)
- 91.** 0.01 : 0.0001 :: 0.05 : ?  
 (1) 0.00025 (2) 0.0025  
 (3) 0.025 (4) 0.25  
 SSC Combined Matric Level (Pre)  
 Exam.30.07.2006 (Ist Sitting)  
 (East Zone)
- 92.** 2112 : 8118 :: 1221 : ?  
 (1) 1881 (2) 8181  
 (3) 1188 (4) 1118  
 SSC Combined Matric Level (Pre)  
 Exam.30.07.2006 (Ist Sitting)  
 (East Zone)
- 93.** 19 : 59 :: 17 : ?  
 (1) 51 (2) 53  
 (3) 55 (4) 57  
 SSC Combined Matric Level (Pre)  
 Exam.30.07.2006 (IInd Sitting)  
 (Central Zone)
- 94.** 14 : 20 :: 16 : ?  
 (1) 23 (2) 48  
 (3) 10 (4) 32  
 SSC Combined Matric Level (Pre)  
 Exam.30.07.2006 (IInd Sitting)  
 (Central Zone)
- 95.** 100 : 10<sup>2</sup> :: 100000 : ?  
 (1) 10<sup>5</sup> (2) 10<sup>4</sup>  
 (3) 100<sup>3</sup> (4) 100<sup>4</sup>  
 SSC Combined Matric Level (Pre)  
 Exam.30.07.2006 (IInd Sitting)  
 (Central Zone)
- 96.** 10 : 101 :: 20 : ?  
 (1) 200 (2) 201  
 (3) 400 (4) 401  
 SSC Combined Matric Level (Pre)  
 Exam. 30.03.2008 (Ist Sitting)
- 97.** 435 : 768 :: 324 : ?  
 (1) 657 (2) 567  
 (3) 765 (4) 675  
 SSC Combined Matric Level (Pre)  
 Exam. 30.03.2008 (Ist Sitting)
- 98.** 11 : 121 : 110 :: 15 : 225 : 210 ::?  
 (1) 9 : 81 : 70  
 (2) 19 : 361 : 342  
 (3) 17 : 288 : 272  
 (4) 16 : 255 : 239  
 SSC Combined Matric Level (Pre)  
 Exam. 30.03.2008 (Ist Sitting)
- 99.** 16 : 49 :: 100 : ?  
 (1) 85 (2) 121  
 (3) 144 (4) 169  
 SSC Data Entry Operator  
 Exam. 31.08.2008
- 100.** 15 : 220 :: 25 : ?  
 (1) 600 (2) 620  
 (3) 625 (4) 650  
 SSC Data Entry Operator  
 Exam. 31.08.2008
- 101.** 400 : 20 :: 484 : ?  
 (1) 20 (2) 21  
 (3) 22 (4) 23  
 SSC Data Entry Operator  
 Exam. 02.08.2009
- 102.** 4 : 32 :: 7 : ?  
 (1) 98 (2) 343  
 (3) 88 (4) 49  
 SSC Data Entry Operator  
 Exam. 02.08.2009
- 103.** 624 : 426 :: 745 : ?  
 (1) 475 (2) 726  
 (3) 547 (4) 645  
 SSC Data Entry Operator  
 Exam. 02.08.2009
- 104.** 11 : 119 :: 15 : ?  
 (1) 154 (2) 223  
 (3) 233 (4) 152  
 SSC Stenographer (Grade'C & D')  
 Exam. 26.09.2010
- 105.** 21 : 3 :: 574 : ?  
 (1) 23 (2) 82  
 (3) 97 (4) 113  
 SSC Stenographer (Grade'C & D')  
 Exam. 26.09.2010
- 106.** 2 : 0 :: 3 : ?  
 (1) 18 (2) 19  
 (3) 20 (4) 21  
 SSC Stenographer (Grade'C & D')  
 Exam. 26.09.2010
- 107.** 83 : 25 :: 29 : ?  
 (1) 25 (2) 16  
 (3) 49 (4) 36  
 (SSC Higher Secondary Level  
 Data Entry Operator & LDC  
 Exam.27.11.2010)
- 108.** 6 : 35 :: 7 : ?  
 (1) 48 (2) 42  
 (3) 34 (4) 13  
 (SSC Higher Secondary Level  
 Data Entry Operator & LDC  
 Exam.27.11.2010)
- 109.** 4 : 24 :: 17 : ?  
 (1) 37 (2) 47  
 (3) 57 (4) 67  
 (SSC Higher Secondary Level  
 Data Entry Operator & LDC  
 Exam.27.11.2010)

**ANALOGY OR SIMILARITY**

- 110.** 365 : 90 :: 623 : ?  
 (1) 36 (2) 45  
 (3) 123 (4) 63  
 (SSC Higher Secondary Level Data Entry Operator & LDC Exam. 28.11.2010 (Ist sitting))
- 111.** 248 : 3 :: 328 : ?  
 (1) 7 (2) 5  
 (3) 4 (4) 6  
 (SSC Higher Secondary Level Data Entry Operator & LDC Exam. 28.11.2010 (Ist sitting))
- 112.** 212 : 436 :: 560 : ?  
 (1) 786 (2) 682  
 (3) 784 (4) 688  
 (SSC Higher Secondary Level Data Entry Operator & LDC Exam. 28.11.2010 (Ist sitting))
- 113.** 7 : 48 :: 12 : ?  
 (1) 143 (2) 84  
 (3) 121 (4) 112  
 (SSC Higher Secondary Level Data Entry Operator & LDC Exam. 28.11.2010 (IInd sitting))
- 114.** 72 : 18 :: 56 : ?  
 (1) 24 (2) 22  
 (3) 20 (4) 16  
 (SSC Higher Secondary Level Data Entry Operator & LDC Exam. 28.11.2010 (IInd sitting))
- 115.** 6 : 21 :: 3 : ?  
 (1) 28 (2) 18  
 (3) 61 (4) 32  
 (SSC Higher Secondary Level Data Entry Operator & LDC Exam. 28.11.2010 (IInd sitting))
- 116.** 68 : 130 :: ? : 350  
 (1) 210 (2) 222  
 (3) 240 (4) 282  
 (SSC Stenographer Grade 'C' & 'D' Exam. 09.01.2011)
- 117.** 128 : 96 :: 244 : ?  
 (1) 183 (2) 122  
 (3) 138 (4) 302  
 (SSC Stenographer Grade 'C' & 'D' Exam. 09.01.2011)
- 118.** 85 : 42 :: 139 : ?  
 (1) 68 (2) 69  
 (3) 70 (4) 67  
 (SSC Multi-Tasking (Non-Technical) Staff Exam. 20.02.2011)
- 119.** 8 : 28 :: 27 : ?  
 (1) 8 (2) 28  
 (3) 64 (4) 65  
 (SSC Multi-Tasking (Non-Technical) Staff Exam. 27.02.2011)
- 120.** 5 : 30 :: 7 : ?  
 (1) 54 (2) 50  
 (3) 49 (4) 56  
 (SSC CISF Constable (GD) Exam. 05.06.2011)
- 121.** 7 : 32 :: 35 : ?  
 (1) 144 (2) 156  
 (3) 160 (4) 172  
 (SSC Stenographer (Grade 'C' & 'D') Exam. 16.10.2011)
- 122.** 64 : 100 :: 49 : ?  
 (1) 36 (2) 63  
 (3) 81 (4) 144  
 (SSC Stenographer (Grade 'C' & 'D') Exam. 16.10.2011)
- 123.** 25 : 81 :: 36 : ?  
 (1) 121 (2) 93  
 (3) 65 (4) 103  
 (SSC (10+2) Level Data Entry Operator & LDC Exam. 04.12.2011 (Ist Sitting (North Zone)))
- 124.** 292 : 146 :: 582 : ?  
 (1) 272 (2) 286  
 (3) 291 (4) 292  
 (SSC (10+2) Level Data Entry Operator & LDC Exam. 04.12.2011 (Ist Sitting (North Zone)))
- 125.** 6 : 18 :: 4 : ?  
 (1) 10 (2) 8  
 (3) 6 (4) 4  
 (SSC (10+2) Level Data Entry Operator & LDC Exam. 04.12.2011 (Ist Sitting (North Zone)))
- 126.** 3 : 27 :: 7 : ?  
 (1) 21 (2) 42  
 (3) 147 (4) 343  
 (SSC (10+2) Level Data Entry Operator & LDC Exam. 04.12.2011 (IInd Sitting (North Zone)))
- 127.** 9 : 28 :: 56 : ?  
 (1) 3 (2) 18  
 (3) 112 (4) 169  
 (SSC (10+2) Level Data Entry Operator & LDC Exam. 04.12.2011 (IInd Sitting (North Zone)))
- 128.** 12 : 35 :: 16 : ?  
 (1) 78 (2) 32  
 (3) 55 (4) 63  
 (SSC (10+2) Level Data Entry Operator & LDC Exam. 04.12.2011 (IInd Sitting (North Zone)))
- 129.** 3 : 27 :: 4 : ?  
 (1) 16 (2) 64  
 (3) 28 (4) 32  
 (SSC (10+2) Level Data Entry Operator & LDC Exam. 04.12.2011 (Ist Sitting (East Zone)))
- 130.** 18 : 52 :: 12 : ?  
 (1) 34 (2) 48  
 (3) 60 (4) 72  
 (SSC (10+2) Level Data Entry Operator & LDC Exam. 04.12.2011 (Ist Sitting (East Zone)))
- 131.** 8 : 9 :: 64 : ?  
 (1) 16 (2) 20  
 (3) 25 (4) 36  
 (SSC (10+2) Level Data Entry Operator & LDC Exam. 04.12.2011 (Ist Sitting (East Zone)))
- 132.** 16 : 4 :: 9 : ?  
 (1) 4 (2) 25  
 (3) 1 (4) 2  
 (SSC (10+2) Level Data Entry Operator & LDC Exam. 04.12.2011 (IInd Sitting (East Zone)))
- 133.** 27 : ? :: 125 : 25  
 (1) 3 (2) 9  
 (3) 18 (4) 125  
 (SSC (10+2) Level Data Entry Operator & LDC Exam. 04.12.2011 (IInd Sitting (East Zone)))
- 134.** 25 : 125 :: ? : 3125  
 (1) 525 (2) 625  
 (3) 725 (4) 825  
 (SSC (10+2) Level Data Entry Operator & LDC Exam. 04.12.2011 (IInd Sitting (East Zone)))
- 135.** 196 : 169 :: 81 : ?  
 (1) 64 (2) 72  
 (3) 100 (4) 144  
 (SSC (10+2) Level Data Entry Operator & LDC Exam. 11.12.2011 (Ist Sitting (Delhi Zone)))
- 136.** 30 : ? :: 130 : 222  
 (1) 30 (2) 40  
 (3) 66 (4) 68  
 (SSC (10+2) Level Data Entry Operator & LDC Exam. 11.12.2011 (Ist Sitting (Delhi Zone)))
- 137.** 4, 16, 4 : 2, 4, 2 :: ? : 3, 9, 3  
 (1) 6, 9, 6 (2) 9, 81, 9  
 (3) 9, 27, 9 (4) 9, 18, 9  
 (SSC (10+2) Level Data Entry Operator & LDC Exam. 11.12.2011 (Ist Sitting (Delhi Zone)))
- 138.** 6524 : 6465 :: 9638 : ?  
 (1) 9825 (2) 9736  
 (3) 9697 (4) 9579  
 (SSC (10+2) Level Data Entry Operator & LDC Exam. 11.12.2011 (IInd Sitting (Delhi Zone)))

**ANALOGY OR SIMILARITY**

- 139.** 64 : 144 :: 256 : ?  
 (1) 16 (2) 32  
 (3) 400 (4) 336  
 SSC (10+2) Level Data Entry Operator & LDC Exam. 11.12.2011 (IInd Sitting) (Delhi Zone)
- 140.** 08 : 28 :: 15 : ?  
 (1) 63 (2) 65  
 (3) 126 (4) 124  
 SSC (10+2) Level Data Entry Operator & LDC Exam. 11.12.2011 (IInd Sitting) (Delhi Zone)
- 141.** 625 : 25 :: 225 : ?  
 (1) 13 (2) 14  
 (3) 15 (4) 16  
 SSC (10+2) Level Data Entry Operator & LDC Exam. 11.12.2011 (Ist Sitting) (East Zone)
- 142.** 49 : 216 :: 36 : ?  
 (1) 25 (2) 125  
 (3) 625 (4) 3125  
 SSC (10+2) Level Data Entry Operator & LDC Exam. 11.12.2011 (Ist Sitting) (East Zone)
- 143.** 2, 4, 2 : 4, 16, 4 :: 1, 1, 1 : ?  
 (1) 2, 4, 2 (2) 1, 1, 1  
 (3) 2, 2, 2 (4) 2, 13, 2  
 SSC (10+2) Level Data Entry Operator & LDC Exam. 11.12.2011 (Ist Sitting) (East Zone)
- 144.** 1, 2, 4, 7 : 3, 4, 6, 9 :: ? : ?  
 2, 3, 5, 8  
 (1) 0, 1, 3, 6 (2) 2, 4, 5, 8  
 (3) 1, 3, 4, 7 (4) 3, 5, 6, 8  
 SSC (10+2) Level Data Entry Operator & LDC Exam. 11.12.2011 (IInd Sitting) (East Zone)
- 145.** 6:17 : : 9 : ?  
 (1) 25 (2) 26  
 (3) 27 (4) 28  
 SSC (10+2) Level Data Entry Operator & LDC Exam. 11.12.2011 (IInd Sitting) (East Zone)
- 146.** 9 : 81 :: 12 : ?  
 (1) 124 (2) 104  
 (3) 134 (4) 144  
 SSC (10+2) Level Data Entry Operator & LDC Exam. 11.12.2011 (IInd Sitting) (East Zone)
- 147.** 7 : 45 :: 5 : ?  
 (1) 20 (2) 30  
 (3) 33 (4) 43  
 SSC Constable (GD) & Rifleman (GD) Exam.22.04.2012 (Ist Sitting)
- 148.** 7 : 28 :: 2 : ?  
 (1) 8 (2) 12  
 (3) 16 (4) 24  
 SSC Constable (GD) & Rifleman (GD) Exam. 22.04.2012 (IInd Sitting)
- 149.** 49 : 64 :: 144 : ?  
 (1) 256 (2) 169  
 (3) 186 (4) 121  
 (SSC Level Data Entry Operator & LDC Exam.21.10.2012 (Ist Sitting))
- 150.** 8 : 12 :: 9 : 13 :: 10 : 14 :: ?  
 (1) 15 : 19 (2) 14 : 11  
 (3) 11 : 15 (4) 8 : 15  
 (SSC Level Data Entry Operator & LDC Exam. 21.10.2012 (IInd Sitting))
- 151.** XXIV : 48 :: XIV : ?  
 (1) 28 (2) 24  
 (3) 14 (4) 30  
 (SSC Level Data Entry Operator & LDC Exam. 21.10.2012 (IInd Sitting))
- 152.** 49 : 343 :: 64 : ?  
 (1) 512 (2) 412  
 (3) 416 (4) 516  
 (SSC Level Data Entry Operator & LDC Exam. 28.10.2012 (Ist Sitting))
- 153.** 24 : 60 :: 210 : ?  
 (1) 505 (2) 425  
 (3) 420 (4) 525  
 (SSC Level Data Entry Operator & LDC Exam. 28.10.2012 (Ist Sitting))
- 154.** 6 : 29 :: 24 : ?  
 (1) 109 (2) 129  
 (3) 119 (4) 99  
 (SSC Level Data Entry Operator & LDC Exam. 04.11.2012 (IInd Sitting))
- 155.** 7 : 30 :: 17 : ?  
 (1) 18 (2) 70  
 (3) 210 (4) 54  
 (SSC Level Data Entry Operator & LDC Exam. 04.11.2012 (IInd Sitting))
- 156.** 72 : 40 :: ? : 30  
 (1) 64 (2) 54  
 (3) 66 (4) 48  
 (FCI Assistant Grade-II Exam. 22.01.2012 Paper-I)
- 157.** 6 : 12 :: 20 : ?  
 (1) 50 (2) 30  
 (3) 42 (4) 38  
 (FCI Assistant Grade-II Exam. 22.01.2012 Paper-I)
- 158.** 5 : 135 :: 7 : ?  
 (1) 353 (2) 245  
 (3) 273 (4) 293  
 (FCI Assistant Grade-II Exam. 22.01.2012 Paper-I)
- 159.** 5 : 30 :: 8 : ?  
 (1) 14 (2) 50  
 (3) 69 (4) 80  
 FCI Assistant Grade-III Exam. 25.02.2012 (Paper-I) North Zone (Ist Sitting)
- 160.** 12 : 30 :: 20 : ?  
 (1) 48 (2) 32  
 (3) 35 (4) 42  
 FCI Assistant Grade-III Exam. 25.02.2012 (Paper-I) North Zone (Ist Sitting)
- 161.** 3 : 28 :: 5 : ?  
 (1) 179 (2) 126  
 (3) 124 (4) 125  
 FCI Assistant Grade-III Exam. 25.02.2012 (Paper-I) North Zone (Ist Sitting)
- 162.** 2 : 7 :: 3 : ?  
 (1) 8 (2) 12  
 (3) 26 (4) 28  
 FCI Assistant Grade-III Exam. 05.02.2012 (Paper-I) East Zone (IInd Sitting)
- 163.** 12 : 90 :: 16 : ?  
 (1) 108 (2) 112  
 (3) 120 (4) 256  
 FCI Assistant Grade-III Exam. 05.02.2012 (Paper-I) East Zone (IInd Sitting)
- 164.** 7 : 50 :: 17 : ?  
 (1) 288 (2) 118  
 (3) 290 (4) 324  
 FCI Assistant Grade-III Exam. 05.02.2012 (Paper-I) East Zone (IInd Sitting)
- 165.** 27 : 125 :: 64 : ?  
 (1) 162 (2) 216  
 (3) 273 (4) 517  
 (SSC (10+2) Level Data Entry Operator & LDC Exam. 04.11.2012, Ist Sitting)
- 166.** 8 : 62 :: 9 : ?  
 (1) 64 (2) 79  
 (3) 18 (4) 81  
 (SSC (10+2) Level Data Entry Operator & LDC Exam. 04.11.2012, Ist Sitting)
- 167.** 125 : 5 :: 64 : ?  
 (1) 8 (2) 4  
 (3) 2 (4) 32  
 (SSC Multi-Tasking Staff Exam. 10.03.2013, Ist Sitting : Patna)
- 168.** 6 : 8 :: 3 : ?  
 (1) 2 (2) 4  
 (3) 6 (4) 8  
 (SSC Multi-Tasking Staff Exam. 10.03.2013)
- 169.** 583 : 488 :: 293 : ?  
 (1) 378 (2) 487  
 (3) 581 (4) 291  
 (SSC Graduate Level Tier-I Exam. 21.04.2013, Ist Sitting)

**ANALOGY OR SIMILARITY**

- 170.** 25 : 625 :: 35 : ?  
 (1) 875 (2) 635  
 (3) 1575 (4) 1205  
 (SSC Graduate Level Tier-I Exam. 21.04.2013, 1st Sitting)
- 171.** 525 : 25 :: 315 : ?  
 (1) 10 (2) 15  
 (3) 5 (4) 25  
 (SSC Graduate Level Tier-I Exam. 21.04.2013, IIInd Sitting)
- 172.** 25 : 175 :: 32 : ?  
 (1) 150 (2) 170  
 (3) 162 (4) 160  
 (SSC Graduate Level Tier-I Exam. 21.04.2013, IIInd Sitting)
- 173.** 11 : 1331 :: 9 : ?  
 (1) 979 (2) 991  
 (3) 729 (4) 879  
 (SSC Constable (GD) Exam. 12.05.2013)
- 174.** 32 : 66 :: 134 : ?  
 (1) 271 (2) 268  
 (3) 270 (4) 275  
 (SSC Constable (GD) Exam. 12.05.2013 Ist Sitting)
- 175.** 600 : 2000 :: ? : 9000  
 (1) 3000 (2) 3600  
 (3) 5400 (4) 5600  
 (SSC Graduate Level Tier-I Exam. 19.05.2013, Ist Sitting)
- 176.** 9 : 7 :: 80 : ?  
 (1) 48 (2) 50  
 (3) 78 (4) 82  
 (SSC Graduate Level Tier-I Exam. 19.05.2013, IIInd Sitting)
- 177.** 7 : 133 :: 9 : ?  
 (1) 147 (2) 99  
 (3) 171 (4) 158  
 (SSC CAPFs SI & CISF ASI Exam. 23.06.2013)
- 178.** 36 : 216 :: 81 : ?  
 (1) 729 (2) 629  
 (3) 319 (4) 826  
 (SSC CAPFs SI & CISF ASI Exam. 23.06.2013)
- 179.** 17 : 4 :: 37 : ?  
 (1) 5 (2) 6  
 (3) 7 (4) 8  
 (SSC Cabinet Secretariat RO (ECO), DFO (T) & DFO (GD) Tier-I Exam. 23.06.2013)
- 180.** 29 : 319 :: 23 : ?  
 (1) 252 (2) 115  
 (3) 46 (4) 151  
 (SSC Cabinet Secretariat RO (ECO), DFO (T) & DFO (GD) Tier-I Exam. 23.06.2013)
- 181.** 18 : 30 :: 36 : ?  
 (1) 54 (2) 62  
 (3) 64 (4) 66  
 (SSC Cabinet Secretariat RO (ECO), DFO (T) & DFO (GD) Tier-I Exam. 23.06.2013)
- 182.** 09 : 81 :: 04 : ?  
 (1) 16 (2) 25  
 (3) 36 (4) 49  
 (SSC Multi-Tasking (Non-Tech.) Staff Exam. 16.02.2014)
- 183.** 100 : 121 :: 144 : ?  
 (1) 160 (2) 93  
 (3) 169 (4) 426  
 (SSC Multi-Tasking Staff (Patna) Exam. 16.02.2014)
- 184.** 8 : 56 :: 9 : ?  
 (1) 10 (2) 63  
 (3) 7 (4) 9  
 (SSC Multi-Tasking (Non-Tech.) Staff Exam. 23.02.2014, IIInd Sitting)
- 185.** 82 : 06 :: 76 : ?  
 (1) 15 (2) 01  
 (3) 12 (4) 24  
 (SSC CGL Tier-I Re-Exam-2013, 27.04.2014)
- 186.** 11 : 132 :: ?  
 (1) 10 : 100 (2) 9 : 90  
 (3) 13 : 169 (4) 15 : 250  
 (SSC CGL Tier-I Re-Exam-2013, 27.04.2014 & Bihar SSC 2nd Graduate (Pre) Exam-16.02.2015)
- 187.**  $\frac{1}{9} : \frac{1}{81} :: \frac{1}{13} : ?$   
 (1)  $\frac{1}{169}$  (2)  $\frac{1}{125}$   
 (3)  $\frac{1}{120}$  (4)  $\frac{1}{127}$   
 (SSC CGL Tier-I Re-Exam-2013, 27.04.2014 & Bihar SSC 2nd Graduate (Pre) Exam-16.02.2015)
- 188.** 18 : 5 :: 12 : ?  
 (1) 4 (2) 10  
 (3) 3 (4) 6  
 (SSC CAPFs SI, CISF ASI & Delhi Police SI Exam. 22.06.2014)
- 189.** 12 : 20 :: ?  
 (1) 15 : 37 (2) 16 : 64  
 (3) 27 : 48 (4) 30 : 42  
 (SSC CAPFs SI, CISF ASI & Delhi Police SI Exam. 22.06.2014)
- 190.** 33 : 10 :: 54 : ?  
 (1) 15 (2) 17  
 (3) 19 (4) 21  
 (SSC CAPFs SI, CISF ASI & Delhi Police SI Exam. 22.06.2014)
- 191.** 10 : 99 :: ?  
 (1) 6 : 37 (2) 7 : 45  
 (3) 8 : 63 (4) 9 : 85  
 (SSC CAPFs SI, CISF ASI & Delhi Police SI Exam. 22.06.2014)
- 192.** 20 : 11 :: 102 : ?  
 (1) 52 (2) 49  
 (3) 61 (4) 96  
 (SSC GL Tier-I Re-Exam. (2013) 20.07.2014, IIInd Sitting)
- 193.** 6415 : 5304 :: 7896 : ?  
 (1) 6705 (2) 6905  
 (3) 6907 (4) 6785  
 (SSC GL Tier-I Re-Exam. (2013) 20.07.2014, IIInd Sitting & Bihar SSC 2nd Graduate Level (Pre) Exam-23.02.2015)
- 194.** 18 : 162 :: 36 : ?  
 (1) 984 (2) 1296  
 (3) 72 (4) 648  
 (SSC GL Tier-I Re-Exam. (2013) 20.07.2014, IIInd Sitting)
- 195.** 9536 : 6203 :: 5873 : ?  
 (1) 2540 (2) 2343  
 (3) 2353 (4) 2531  
 (SSC GL Tier-I Re-Exam. (2013) 20.07.2014, IIInd Sitting)
- 196.**  $\frac{1}{8} : \frac{1}{64} :: \frac{1}{16} : ?$   
 (1) 128 (2) 126  
 (3) 144 (4) 132  
 (SSC GL Tier-I Exam. 19.10.2014, Ist Sitting)
- 197.** 29 : 71 :: 79 : ?  
 (1) 120 (2) 192  
 (3) 197 (4) 131  
 (SSC GL Tier-I Exam. 19.10.2014, Ist Sitting)
- 198.** 91 : ? :: 64 : 54  
 (1) 63 (2) 101  
 (3) 32 (4) 70  
 (SSC GL Tier-I Exam. 19.10.2014)
- 199.**  $\frac{2}{3} : \frac{19}{29} :: \frac{8}{7} : ?$   
 (1)  $\frac{89}{79}$  (2)  $\frac{79}{79}$   
 (3)  $\frac{79}{69}$  (4)  $\frac{80}{70}$   
 (SSC GL Tier-I Exam. 19.10.2014)
- 200.** 23 : 13 :: 54 : ?  
 (1) 40 (2) 41  
 (3) 44 (4) 39  
 (SSC GL Tier-I Exam. 26.10.2014)

**ANALOGY OR SIMILARITY**

- 201.** 17 : 24 :: 153 : ?  
 (1) 213 (2) 216  
 (3) 118 (4) 198  
 (SSC GL Tier-I Exam. 26.10.2014)
- 202.** 3 : 11 :: 7 : ?  
 (1) 22 (2) 29  
 (3) 51 (4) 18  
 (SSC CHSL (10+2) DEO & LDC  
 Exam. 02.11.2014, Patna Region :  
 Ist Sitting)
- 203.** 6 : 18 :: 4 : ?  
 (1) 2 (2) 6  
 (3) 8 (4) 16  
 (SSC CHSL (10+2) DEO & LDC  
 Exam. 02.11.2014, Patna Region :  
 Ist Sitting)
- 204.** 7 : 56 :: 9 : ?  
 (1) 63 (2) 81  
 (3) 90 (4) 99  
 (SSC CHSL (10+2) DEO & LDC  
 Exam. 02.11.2014, Patna Region :  
 Ist Sitting)
- 205.** 13 : 169 :: ?  
 (1) 12 : 140 (2) 3 : 6  
 (3) 11 : 111 (4) 9 : 81  
 (SSC CHSL (10+2) DEO & LDC  
 Exam. 02.11.2014, IInd Sitting)
- 206.** 23 : 29 :: 41 : ?  
 (1) 43 (2) 45  
 (3) 47 (4) 49  
 (SSC CHSL (10+2) DEO & LDC  
 Exam. 02.11.2014, IInd Sitting)
- 207.** 6 : 10 :: 9 : ?  
 (1) 10 (2) 12  
 (3) 15 (4) 18  
 (SSC CHSL (10+2) DEO & LDC  
 Exam. 02.11.2014, IInd Sitting)
- 208.** 7 : 24 :: ?  
 (1) 30 : 100 (2) 23 : 72  
 (3) 19 : 58 (4) 11 : 43  
 (SSC CHSL (10+2) DEO & LDC  
 Exam. 09.11.2014)
- 209.** 12 : 140 :: 156 : ?  
 (1) 1820 (2) 1500  
 (3) 1250 (4) 1121  
 (SSC CHSL (10+2) DEO & LDC  
 Exam. 09.11.2014)
- 210.** 64 : 4 :: ? : 9  
 (1) 18 (2) 729  
 (3) 81 (4) 144  
 (SSC CHSL (10+2) DEO & LDC  
 Exam. 09.11.2014)
- 211.** 8 : 23 :: 48 : ?  
 (1) 90 (2) 138  
 (3) 168 (4) 112  
 (SSC CHSL (10+2) DEO & LDC  
 Exam. 16.11.2014, Patna Region :  
 Ist Sitting)

- 212.** 5 : 28 :: 8 : ?  
 (1) 40 (2) 64  
 (3) 25 (4) 67  
 (SSC CHSL (10+2) DEO & LDC  
 Exam. 16.11.2014, Patna Region :  
 Ist Sitting)
- 213.** 42 : 20 :: 64 : ?  
 (1) 31 (2) 32  
 (3) 40 (4) 42  
 (SSC CHSL (10+2) DEO & LDC  
 Exam. 16.11.2014)
- Directions** % In each of the following questions, select the related number from the given alternatives.
- 214.** 8 : 256 :: ?  
 (1) 7 : 343 (2) 9 : 243  
 (3) 10 : 500 (4) 5 : 75  
 (SSC CGL Tier-I Exam. 19.10.2014  
 TF No. 022 MH 3)
- 215.** 21 : 3 :: 574 : ?  
 (1) 23 (2) 82  
 (3) 97 (4) 113  
 (SSC CGL Tier-I Exam. 19.10.2014  
 TF No. 022 MH 3)
- 216.** 7 : 42 :: 9 : ?  
 (1) 64 (2) 72  
 (3) 46 (4) 80  
 (SSC CHSL (10+2) DEO & LDC  
 Exam. 16.11.2014, Ist Sitting  
 TF No. 333 LO 2)
- 217.** 121 : 12 :: 25 : ?  
 (1) 1 (2) 2  
 (3) 6 (4) 7  
 (SSC CHSL (10+2) DEO & LDC  
 Exam. 16.11.2014, Ist Sitting  
 TF No. 333 LO 2)
- 218.** 0.16 : 0.0016 :: 1.02 : ?  
 (1) 0.0102 (2) 0.102  
 (3) 1.020 (4) 10.20  
 (SSC CHSL (10+2) DEO & LDC  
 Exam. 16.11.2014, Ist Sitting  
 TF No. 333 LO 2)
- 219.** 27 : 3 :: 873 : ?  
 (1) 23 (2) 97  
 (3) 9 (4) 87  
 (SSC CHSL (10+2) DEO & LDC  
 Exam. 16.11.2014, IInd Sitting  
 TF No. 545 QP 6)
- 220.** 6 : 34 :: 9 : ?  
 (1) 36 (2) 45  
 (3) 81 (4) 79  
 (SSC CHSL (10+2) DEO & LDC  
 Exam. 16.11.2014, IInd Sitting  
 TF No. 545 QP 6)

- 221.** 352 : 30  
 296 : 108  
 628 : ?  
 (1) 306 (2) 96  
 (3) 314 (4) 36  
 (SSC CHSL (10+2) DEO & LDC  
 Exam. 16.11.2014, IInd Sitting  
 TF No. 545 QP 6)
- 222.** 9 : 24 :: ? : 6  
 (1) 3 (2) 2  
 (3) 1 (4) 5  
 (SSC CAPFs SI, CISF ASI & Delhi  
 Police SI Exam, 21.06.2015  
 (Ist Sitting) TF No. 8037731)
- 223.** 01 : 08 :: 16 : ?  
 (1) 125 (2) 25  
 (3) 27 (4) 64  
 (SSC CAPFs SI, CISF ASI & Delhi  
 Police SI Exam, 21.06.2015  
 IInd Sitting)
- 224.** 2 : 32 :: 3 : ?  
 (1) 143 (2) 243  
 (3) 293 (4) 183  
 (SSC CGL Tier-I Exam, 09.08.2015  
 (Ist Sitting) TF No. 1443088)
- 225.** 16 : 22 :: 36 : ?  
 (1) 44 (2) 24  
 (3) 26 (4) 46  
 (SSC CGL Tier-I Exam, 09.08.2015  
 (IInd Sitting) TF No. 4239378)
- 226.** 9 : 50 :: ?  
 (1) 22 : 110 (2) 18 : 190  
 (3) 15 : 225 (4) 20 : 105  
 (SSC CGL Tier-I Exam, 09.08.2015  
 (IInd Sitting) TF No. 4239378)
- 227.** 6 : 42 :: 7 : ?  
 (1) 40 (2) 56  
 (3) 48 (4) 52  
 (SSC CGL Tier-I Exam, 16.08.2015  
 (Ist Sitting) TF No. 3196279)
- 228.** 12 : 72 :: 8 : ?  
 (1) 36 (2) 38  
 (3) 40 (4) 32  
 (SSC CGL Tier-I Exam, 16.08.2015  
 (Ist Sitting) TF No. 3196279)
- 229.** 4 : 17 :: 7 : ?  
 (1) 50 (2) 48  
 (3) 49 (4) 51  
 (SSC CGL Tier-I Exam, 16.08.2015  
 (IInd Sitting) TF No. 2176783)
- 230.** 4 : 64 :: 2 : ?  
 (1) 16 (2) 8  
 (3) 22 (4) 12  
 (SSC CGL Tier-I  
 Re-Exam, 30.08.2015)

**ANALOGY OR SIMILARITY**

- 231.** 49 : 56 :: 36 : ?  
 (1) 52 (2) 44  
 (3) 42 (4) 43  
 (SSC CGL Tier-I Re-Exam, 30.08.2015)
- 232.** 4 : 19 :: 7 : ?  
 (1) 52 (2) 68  
 (3) 49 (4) 28  
 (SSC Constable (GD) Exam, 04.10.2015, 1st Sitting)
- 233.** 8 : 81 :: 64 : ?  
 (1) 525 (2) 625  
 (3) 125 (4) 137  
 (SSC Constable (GD) Exam, 04.10.2015, IIInd Sitting)
- 234.** 17 : 102 :: 23 : ?  
 (1) 138 (2) 216  
 (3) 112 (4) 413  
 (SSC (10+2) LDC/DEO/PA/SA Exam, 01.11.2015 TF No. 1098066)
- 235.** 235 : 587 :: 435 : ?  
 (1) 788 (2) 989  
 (3) 789 (4) 988  
 (SSC (10+2) LDC/DEO/PA/SA Exam, 01.11.2015 TF No. 1098066)
- 236.** 414 : 636 :: 325 : ?  
 (1) 547 (2) 414  
 (3) 222 (4) 636  
 (SSC CHSL (10+2) LDC, DEO & PA/SA Exam, 01.11.2015, IIInd Sitting)
- 237.** 196 : 256 :: ? : 400  
 (1) 144 (2) 452  
 (3) 324 (4) 204  
 (SSC CHSL (10+2) LDC, DEO & PA/SA Exam, 01.11.2015, IIInd Sitting)
- 238.** 32 : 28 :: 160 : ?  
 (1) 140 (2) 120  
 (3) 110 (4) 80  
 (SSC CHSL (10+2) LDC, DEO & PA/SA Exam, 01.11.2015, IIInd Sitting)
- 239.** 49 : 343 :: 64 : ?  
 (1) 514 (2) 634  
 (3) 512 (4) 486  
 (SSC CHSL (10+2) LDC, DEO & PA/SA Exam, 15.11.2015 (1st Sitting) TF No. 6636838)
- 240.** 7 : 77 :: ?  
 (1) 6 : 24 (2) 8 : 64  
 (3) 11 : 143 (4) 3 : 81  
 (SSC CHSL (10+2) LDC, DEO & PA/SA Exam, 15.11.2015 (1st Sitting) TF No. 6636838)
- 241.** 7 : 42 :: 8 : ?  
 (1) 50 (2) 49  
 (3) 57 (4) 48  
 (SSC CHSL (10+2) LDC, DEO & PA/SA Exam, 15.11.2015 (1st Sitting) TF No. 6636838)

- 242.**  $\frac{1}{4} : \frac{1}{8} :: \frac{2}{3} : ?$   
 (1)  $\frac{1}{3}$  (2)  $\frac{1}{2}$   
 (3) 1 (4)  $\frac{1}{4}$   
 (SSC CHSL (10+2) LDC, DEO & PA/SA Exam, 15.11.2015 (IIInd Sitting) TF No. 7203752)
- 243.** 42 : 20 :: 64 : ?  
 (1) 32 (2) 33  
 (3) 34 (4) 31  
 (SSC CHSL (10+2) LDC, DEO & PA/SA Exam, 15.11.2015 (IIInd Sitting) TF No. 7203752)
- 244.** 4845 : 45<sup>2</sup> :: 5964 : ?  
 (1) 59<sup>2</sup> (2) 94<sup>2</sup>  
 (3) 96<sup>2</sup> (4) 54<sup>2</sup>  
 (SSC CHSL (10+2) LDC, DEO & PA/SA Exam, 06.12.2015 (1st Sitting) TF No. 1375232)
- 245.** 12593 : 35291  
 29684 : 46982  
 72936 : ?  
 (1) 62793 (2) 92637  
 (3) 69237 (4) 62973  
 (SSC CHSL (10+2) LDC, DEO & PA/SA Exam, 06.12.2015 (1st Sitting) TF No. 1375232)
- 246.** 6 : 18 :: 4 : ?  
 (1) 15 (2) 6  
 (3) 8 (4) 2  
 (SSC CHSL (10+2) LDC, DEO & PA/SA Exam, 06.12.2015 (1st Sitting) TF No. 1375232)
- 247.** 144 : 13 :: 49 : ?  
 (1) 8 (2) 9  
 (3) 10 (4) 11  
 (SSC CHSL (10+2) LDC, DEO & PA/SA Exam, 06.12.2015 (IIInd Sitting) TF No. 3441135)
- 248.** 21 : 3 :: 574 : ?  
 (1) 113 (2) 82  
 (3) 97 (4) 23  
 (SSC CHSL (10+2) LDC, DEO & PA/SA Exam, 06.12.2015 (IIInd Sitting) TF No. 3441135)
- 249.** 6 : 42 :: 5 : ?  
 (1) 35 (2) 40  
 (3) 45 (4) 30  
 (SSC CHSL (10+2) LDC, DEO & PA/SA Exam, 06.12.2015 (IIInd Sitting) TF No. 3441135)

- 250.** 4 : 19 :: 7 : ?  
 (1) 28 (2) 52  
 (3) 68 (4) 49  
 (SSC CHSL (10+2) LDC, DEO & PA/SA Exam, 20.12.2015 (1st Sitting) TF No. 9692918)
- 251.** 4863 - 2436 :: 8132 - 4261 :: ?  
 (1) 6214 - 3122 (2) 9842 - 8421  
 (3) 8346 - 4623 (4) 5926 - 1813  
 (SSC CHSL (10+2) LDC, DEO & PA/SA Exam, 20.12.2015 (1st Sitting) TF No. 9692918)
- 252.** 556 : 186 :: 951 : ?  
 (1) 217 (2) 317  
 (3) 286 (4) 176  
 (SSC CHSL (10+2) LDC, DEO & PA/SA Exam, 20.12.2015 (1st Sitting) TF No. 9692918)
- 253.** 8 : 64 :: 27 : ?  
 (1) 64 (2) 81  
 (3) 212 (4) 125  
 (SSC (10+2) Stenographer Grade 'C' & 'D' Exam, 31.01.2016 TF No. 3513283)
- 254.** 4 : 20 :: 6 : ?  
 (1) 36 (2) 12  
 (3) 8 (4) 42  
 (SSC (10+2) Stenographer Grade 'C' & 'D' Exam, 31.01.2016 TF No. 3513283)
- 255.** 27 : 9 :: 64 : ?  
 (1) 8 (2) 12  
 (3) 16 (4) 20  
 (SSC (10+2) Stenographer Grade 'C' & 'D' Exam, 31.01.2016 TF No. 3513283)

**Directions (256-258) :** In each of the following questions, select the related number from the given alternatives.

- (SSC (10+2) Stenographer Grade 'C' & 'D' Exam, 31.07.2016)
- 256.** 42 : 20 :: 64 : ?  
 (1) 32 (2) 33  
 (3) 34 (4) 31
- 257.** 6 : 18 :: 4 : ?  
 (1) 8 (2) 10  
 (3) 14 (4) 6
- 258.** 8 : 24 :: ? : 32  
 (1) 6 (2) 10  
 (3) 8 (4) 5
- 259.** Select the related number from the given alternatives:  
 42 : 56 :: 110 : ?  
 (1) 18 (2) 132  
 (3) 136 (4) 140  
 (SSC CGL Tier-I (CBE) Exam, 10.09.2016)

**ANALOGY OR SIMILARITY**

**260.** Select the related number from the given alternatives:

381 : 160 :: 478 : ?

- (1) 347           (2) 357  
(3) 247           (4) 257

(SSC CGL Tier-I (CBE)  
Exam.11.09.2016) (Ist Sitting)

**261.** Select the related number from the given alternatives.

169 : 12 :: 25 : ?

- (1) 2               (2) 3  
(3) 5               (4) 4

(SSC CPO SI, ASI Online  
Exam.05.06.2016) (IInd Sitting)

**262.** Select the related letters/words/numbers from the given alternatives.

5 : 36 :: 7 : ?

- (1) 36               (2) 49  
(3) 64               (4) 81

(SSC CPO SI, ASI Online  
Exam.05.06.2016) (IInd Sitting)

**263.** Select the related number from the given alternatives.

24 : 15 :: 63 : ?

- (1) 56               (2) 38  
(3) 58               (4) 48

(SSC CPO Exam. 06.06.2016)  
(Ist Sitting)

**264.** Select the related number from the given alternatives.

200 : 25 :: 300 : ?

- (1) 30               (2) 37.50  
(3) 32.50           (4) 30.25

(SSC CPO Exam. 06.06.2016)  
(Ist Sitting)

**265.** Select the related letter from the given alternatives.

I : 9 :: ? : 13

- (1) J                (2) M  
(3) L                (4) K

(SSC CPO Exam. 06.06.2016)  
(Ist Sitting)

**266.** Select the related numbers from the given alternatives:

01 : 36 :: 02 : ?

- (1) 48               (2) 49  
(3) 69               (4) 70

(SSC CHSL (10+2) Tier-I (CBE)  
Exam. 08.09.2016) (Ist Sitting)

**267.** Select the related numbers from the given alternatives:

12 : 39 :: 15 : ?

- (1) 48               (2) 52  
(3) 39               (4) 51

(SSC CGL Tier-I (CBE)  
Exam. 09.09.2016) (Ist Sitting)

**Directions (268-269) :** In each of the following questions, select the related number from the given alternatives.

(SSC CAPFs (CPO) SI & ASI,  
Delhi Police Exam. 20.03.2016)  
(IInd Sitting)

**268.** 36 : 50 :: 64 : ?

- (1) 78               (2) 70  
(3) 72               (4) 82

**229.** 16 : 64 :: 49 : ?

- (1) 97               (2) 343  
(3) 196             (4) 93

**270.** Select the related number from the given alternatives.

11 : 110 :: 15 : ?

- (1) 149             (2) 210  
(3) 151             (4) 200

(SSC CPO SI & ASI, Online  
Exam. 06.06.2016) (IInd Sitting)

**271.** Select the related number from the given alternatives.

16 : 256 :: ? : 104

- (1) 23               (2) 33  
(3) 13               (4) 27

(SSC CPO SI & ASI, Online  
Exam. 06.06.2016) (IInd Sitting)

**272.** Select the related number from the given alternatives.

19 : 568 :: 25 : ?

- (1) 748             (2) 623  
(3) 799             (4) 654

(SSC CPO SI & ASI, Online  
Exam. 06.06.2016) (IInd Sitting)

**273.** Select the related number from the given alternatives:

5 : 124 :: 7 : ?

- (1) 125             (2) 248  
(3) 342             (4) 343

(SSC CGL Tier-I (CBE)  
Exam. 27.08.2016) (Ist Sitting)

**274.** Select the related number from the given alternatives.

1 : 8 :: ? : 64

- (1) 36               (2) 27  
(3) 30               (4) 25

(SSC CGL Tier-I (CBE)  
Exam. 27.08.2016) (IInd Sitting)

**275.** Select the related number from the given alternatives.

7 : 19 :: 10 : ?

- (1) 25               (2) 30  
(3) 21               (4) 23

(SSC CGL Tier-I (CBE)  
Exam. 28.08.2016) (IInd Sitting)

**276.** Select the related number from the given alternatives.

18 : 30 :: 36 : ?

- (1) 78               (2) 64  
(3) 66               (4) 68

(SSC CGL Tier-I (CBE)  
Exam. 29.08.2016) (IInd Sitting)

**277.** Select the related number from the given alternatives:

24 : 60 :: 210 : ?

- (1) 348             (2) 336  
(3) 340             (4) 326

(SSC CGL Tier-I (CBE)  
Exam. 30.08.2016) (Ist Sitting)

**278.** Select the related numbers from the given alternatives :

6 : 42 :: 12 : ?

- (1) 48               (2) 72  
(3) 60               (4) 84

(SSC CGL Tier-I (CBE)  
Exam. 31.08.2016) (Ist Sitting)

**279.** Select the related number from the given alternatives.

147 : 741 :: 869 : ?

- (1) 896             (2) 968  
(3) 689             (4) 986

(SSC CGL Tier-I (CBE)  
Exam. 01.09.2016) (Ist Sitting)

**280.** Select the related number from the given alternatives.

5 : 100 :: 7 : ?

- (1) 49               (2) 196  
(3) 91               (4) 135

(SSC CGL Tier-I (CBE)  
Exam. 02.09.2016) (Ist Sitting)

**281.** Select the related number from the given alternatives.

7 : 32 :: 28 : ?

- (1) 126             (2) 136  
(3) 116             (4) 128

(SSC CGL Tier-I (CBE)  
Exam. 02.09.2016) (IInd Sitting)

**282.** Select the related number from the given alternatives.

2 : 10 :: 26 : ?

- (1) 50               (2) 36  
(3) 42               (4) 20

(SSC CGL Tier-I (CBE)  
Exam. 03.09.2016) (IInd Sitting)

**283.** Select the related number from the given alternatives :

583 : 295 :: 486 : ?

- (1) 291             (2) 378  
(3) 487             (4) 581

(SSC CGL Tier-I (CBE)  
Exam. 04.09.2016) (Ist Sitting)

**ANALOGY OR SIMILARITY**

- 284.** Select the related numbers from the given alternatives:  
 $121 : 12 :: 25 : ?$   
 (1) 5 (2) 6  
 (3) 7 (4) 8  
 (SSC CGL Tier-I (CBE)  
 Exam. 06.09.2016) (Ist Sitting)
- 285.** Select the related number from the given alternatives.  
 $27 : 125 :: 64 : ?$   
 (1) 517 (2) 162  
 (3) 216 (4) 273  
 (SSC CGL Tier-I (CBE)  
 Exam. 07.09.2016) (Ist Sitting)
- 286.** Select the related number from the given alternatives.  
 $100 : 10^2 :: 100000 : ?$   
 (1)  $10^5$  (2)  $10^4$   
 (3)  $100^3$  (4)  $100^4$   
 (SSC CGL Tier-I (CBE)  
 Exam. 30.08.2016) (IIInd Sitting)
- 287.** Select the related number from the given alternatives :  
 $20 : 11 :: 102 : ?$   
 (1) 49 (2) 52  
 (3) 61 (4) 58  
 (SSC CGL Tier-I (CBE)  
 Exam. 31.08.2016) (IIInd Sitting)
- 288.** Select the related number from the given alternatives :  
 $26 : 48 :: 82 : ?$   
 (1) 125 (2) 122  
 (3) 115 (4) 120  
 (SSC CGL Tier-I (CBE)  
 Exam. 01.09.2016) (Ist Sitting)
- 289.** Select the related numbers from the given alternatives :  
 $6 : 5 :: 8 : ?$   
 (1) 2 (2) 4  
 (3) 6 (4) 10  
 (SSC CGL Tier-I (CBE)  
 Exam. 02.09.2016) (Ist Sitting)
- 290.** Select the related number from the given alternatives :  
 $37 : 65 :: 50 : ?$   
 (1) 75 (2) 79  
 (3) 82 (4) 87  
 (SSC CGL Tier-I (CBE)  
 Exam. 28.08.2016) (Ist Sitting)
- 291.** Select the related number from the given alternatives :  
 $68 : 130 :: 222 : ?$   
 (1) 345 (2) 365  
 (3) 355 (4) 350  
 (SSC CGL Tier-I (CBE)  
 Exam. 29.08.2016) (Ist Sitting)
- 292.** Select the related number-pair from the given alternatives :  
 $12 : 144 :: ?$   
 (1) 10 : 40 (2) 15 : 125  
 (3) 20 : 400 (4) 22 : 464  
 (SSC CGL Tier-I (CBE)  
 Exam. 30.08.2016) (IIInd Sitting)
- 293.** Select the related number from the given alternatives :  
 $456 : 15 :: 789 : ?$   
 (1) 22 (2) 24  
 (3) 26 (4) 28  
 (SSC CGL Tier-I (CBE)  
 Exam. 31.08.2016) (IIInd Sitting)
- 294.** Select the related number from the given alternatives :  
 $4 : 20 :: 8 : ?$   
 (1) 74 (2) 70  
 (3) 72 (4) 78  
 (SSC CGL Tier-I (CBE)  
 Exam. 01.09.2016) (IIInd Sitting)
- 295.** Select the related number from the given alternatives :  
 $9 : 162 :: 8 : ?$   
 (1) 96 (2) 112  
 (3) 128 (4) 160  
 (SSC CGL Tier-I (CBE)  
 Exam. 02.09.2016) (IIInd Sitting)
- 296.** Select the related number from the given alternatives :  
 $841 : 29 :: 289 : ?$   
 (1) 23 (2) 21  
 (3) 17 (4) 13  
 (SSC CGL Tier-I (CBE)  
 Exam. 03.09.2016) (IIIrd Sitting)
- 297.** Select the related number from the given alternatives :  
 $9 : 25 :: 49 : ?$   
 (1) 36 (2) 54  
 (3) 64 (4) 81  
 (SSC CGL Tier-I (CBE)  
 Exam. 04.09.2016) (IIIrd Sitting)
- 298.** Select the related number from the given alternatives :  
 $85 : 42 :: 139 : ?$   
 (1) 68 (2) 69  
 (3) 70 (4) 67  
 (SSC CGL Tier-I (CBE)  
 Exam. 06.09.2016) (IIIrd Sitting)
- 299.** Select the related number from the given alternatives :  
 $8 : 32 :: ? : 108$   
 (1) 22 (2) 24  
 (3) 27 (4) 29  
 (SSC CGL Tier-I (CBE)  
 Exam. 07.09.2016) (IIIrd Sitting)
- 300.** Select the related number from the given alternatives :  
 $12 : 20 :: 30 : ?$   
 (1) 15 (2) 35  
 (3) 42 (4) 48  
 (SSC CGL Tier-I (CBE)  
 Exam. 08.09.2016) (IIIrd Sitting)
- 301.** Select the related number from the given alternatives :  
 $12 : 54 :: 15 : ?$   
 (1) 56 (2) 64  
 (3) 67 (4) 69  
 (SSC CGL Tier-I (CBE)  
 Exam. 09.09.2016) (IIInd Sitting)
- 302.** Select the related number from the given alternatives :  
 $21 : 3 :: 574 : ?$   
 (1) 23 (2) 82  
 (3) 97 (4) 113  
 (SSC CGL Tier-I (CBE)  
 Exam. 10.09.2016) (IIIrd Sitting)
- 303.** Select the related number from the given alternatives :  
 $3 : 243 :: 5 : ?$   
 (1) 125 (2) 625  
 (3) 3025 (4) 3125  
 (SSC CGL Tier-I (CBE)  
 Exam. 03.09.2016) (IIInd Sitting)
- 304.** Select the related numbers from the given alternatives :  
 $5 : 30 :: 7 : ?$   
 (1) 54 (2) 50  
 (3) 49 (4) 56  
 (SSC CGL Tier-I (CBE)  
 Exam. 04.09.2016) (IIInd Sitting)
- 305.** Select the related number from the given alternatives :  
 $15 : 225 :: 12 : ?$   
 (1) 144 (2) 122  
 (3) 112 (4) 222  
 (SSC CGL Tier-I (CBE)  
 Exam. 06.09.2016) (IIInd Sitting)
- 306.** Select the related number from the given alternatives :  
 $4 : 12 :: 5 : ?$   
 (1) 25 (2) 20  
 (3) 22 (4) 30  
 (SSC CGL Tier-I (CBE)  
 Exam. 07.09.2016) (IIInd Sitting)
- 307.** Select the related number from the given alternatives:  
 $342 : 453 :: 831 : ?$   
 (1) 720 (2) 740  
 (3) 922 (4) 942  
 (SSC CGL Tier-I (CBE)  
 Exam. 08.09.2016) (IIInd Sitting)
- 308.** Select the related numbers from the given alternatives :  
 $42 : 20 :: 64 : ?$

**ANALOGY OR SIMILARITY**

- (1) 31                      (2) 32  
(3) 33                      (4) 34

(SSC CGL Tier-I (CBE)  
Exam. 09.09.2016) (IInd Sitting)

**309.** Select the related number from the given alternatives :

- 27 : 125 :: 64 : ?  
(1) 162                      (2) 216  
(3) 273                      (4) 514

(SSC CGL Tier-I (CBE)  
Exam. 10.09.2016) (IInd Sitting)

**310.** Select the related number from the given alternatives :

- 13 : 20 :: 17 : ?  
(1) 25                      (2) 26  
(3) 27                      (4) 28

(SSC CGL Tier-I (CBE)  
Exam. 11.09.2016) (1st Sitting)

**311.** Select the related number from the given alternatives :

- 72 : 90 :: 156 : ?  
(1) 184                      (2) 168  
(3) 182                      (4) 176

(SSC CGL Tier-I (CBE)  
Exam. 11.09.2016) (IInd Sitting)

**312.** Select the related number from the given alternatives :

- 8 : 32 :: 6 : ?  
(1) 12                      (2) 18  
(3) 22                      (4) 26

(SSC CGL Tier-I (CBE)  
Exam. 27.10.2016) (1st Sitting)

**313.** Select the related number from the given alternatives :

- 50 : 90 :: 134 : ?  
(1) 206                      (2) 202  
(3) 208                      (4) 186

(SSC CGL Tier-I (CBE)  
Exam. 27.10.2016) (IInd Sitting)

**314.** Select the related number from the given alternatives :

- 534 : 645 :: 381 : ?  
(1) 446                      (2) 486  
(3) 492                      (4) 412

(SSC CHSL (10+2) Tier-I (CBE)  
Exam. 15.01.2017) (IInd Sitting)

**315.** Select the related number from the given alternatives :

- 12 : 72 :: 13 : ?  
(1) 31                      (2) 84  
(3) 100                      (4) 78

(SSC CHSL (10+2) Tier-I (CBE)  
Exam. 16.01.2017) (IInd Sitting)

**316.** Select the related number from the given alternatives :

- 9 : 8 :: 16 : ?  
(1) 18                      (2) 17  
(3) 14                      (4) 27

(SSC Multi-Tasking Staff  
Exam. 30.04.2017 1st Sitting)

**TYPE-IV**

**Directions :** In each of the following questions, select the related letter from the given alternatives.

**1.** TALE : LATE :: ? : CAFE

- (1) FACE                      (2) CAEF  
(3) CEFA                      (4) FEAC

(SSC Combined Graduate Level Prelim  
Exam. 04.07.1999 (1st Sitting))

**2.** A D H M : Z W S N : C F J O : ?

- (1) YVRM                      (2) WTPK  
(3) XWTP                      (4) ZXVT

(SSC Combined Graduate Level Prelim  
Exam. 04.07.1999 (IInd Sitting))

**3.** BOOD : ERTG :: ANPC : ?

- (1) DQSF                      (2) FSHU  
(3) SHFU                      (4) DSQF

(SSC Combined Graduate Level Prelim  
Exam. 27.02.2000 (1st Sitting))

**4.** AFKP : ZUPK :: BGLQ : ?

- (1) YUQM                      (2) XURO  
(3) YXWV                      (4) YTOJ

(SSC Combined Graduate Level Prelim  
Exam. 27.02.2000 (1st Sitting))

**5.** BVSC : YEHX :: MRCP : ?

- (1) NJXK                      (2) LKXM  
(3) NIXK                      (4) OIYM

(SSC Combined Graduate Level Prelim  
Exam. 27.02.2000 (IInd Sitting))

**6.** EGIK : FILO :: FHJL : ?

- (1) GJMP                      (2) GMJP  
(3) JGMP                      (4) JGPM

(SSC Combined Graduate Level Prelim  
Exam. 27.02.2000 (IInd Sitting))

**7.** ACEG : NPRT :: ADGJ : ?

- (1) NRTX                      (2) ORVX  
(3) NQSU                      (4) NQTW

(SSC Combined Graduate Level Prelim  
Exam. 24.02.2002 (1st Sitting))

**8.** FHEG : JLIK :: PROQ : ?

- (1) TVSU                      (2) VTUS  
(3) TVUS                      (4) SUVT

(SSC Combined Graduate Level Prelim  
Exam. 24.02.2002 (1st Sitting))

**9.** AZBY : DWEV :: HSIR : ?

- (1) JQKO                      (2) KPOL  
(3) KPLO                      (4) KOLP

(SSC Combined Graduate Level Prelim  
Exam. 24.02.2002 (IInd Sitting))

**10.** AKU : ? :: CMW : DNX

- (1) BGL                      (2) BLQ  
(3) BGQ                      (4) BLV

(SSC Combined Graduate Level Prelim  
Exam. 24.02.2002 (IInd Sitting))

**11.** EGIK : WUSQ :: DFHJ : ?

- (1) XVTR                      (2) BDFH  
(3) ECGI                      (4) SQON

(SSC Combined Graduate Level Prelim  
Exam. 24.02.2002 (Middle Zone))

**12.** RED : EFS :: BLUE : ?

- (1) FVMC                      (2) DTKA  
(3) FUNC                      (4) GVND

(SSC Combined Graduate Level Prelim  
Exam. 24.02.2002 (Middle Zone))

**13.** PARTS : STRAP :: WOLF : ?

- (1) FOX                      (2) ANIMAL  
(3) WOOD                      (4) FLOW

SSC Combined Matric Level (Pre)  
Exam. 16.06.2002 (Re-Exam)

**14.** ADBC : WZXY :: EHFG : ?

- (1) STUV                      (2) TUSV  
(3) STVU                      (4) SVTU

(SSC CPO Sub-Inspector  
Exam. 12.01.2003)

**15.** JLNP : OMKI :: SUWY : ?

- (1) MLKJ                      (2) PLHD  
(3) XVTR                      (4) Fghi

(SSC CPO Sub-Inspector  
Exam. 12.01.2003)

**16.** FILM : ADGH :: MILK : ?

- (1) ADGF                      (2) HDGE  
(3) HDGF                      (4) HEGF

(SSC Combined Graduate Level Prelim  
Exam. 11.05.2003 (1st Sitting))

**17.** BJNT : CIOS :: DHPV : ?

- (1) EGQU                      (2) EIOW  
(3) ELPV                      (4) EIOU

(SSC Combined Graduate Level Prelim  
Exam. 11.05.2003 (1st Sitting))

**18.** KIJM : QOPS :: MKLO : ?

- (1) LMOR                      (2) OMNS  
(3) KMOQ                      (4) OMNQ

(SSC Combined Graduate Level Prelim  
Exam. 11.05.2003 (1st Sitting))

**19.** ACEG : IKMO :: PRTV : ?

- (1) QRUV                      (2) JLMP  
(3) WXAC                      (4) XZBD

(SSC Combined Graduate Level Prelim  
Exam. 11.05.2003 (IInd Sitting))

**20.** CLOSE : DNRWJ :: OPEN : ?

- (1) PRJQ                      (2) RPJB  
(3) PRHR                      (4) RZWR

(SSC Combined Graduate Level Prelim  
Exam. 11.05.2003 (IInd Sitting))

**21.** DRIVEN : EIDRVN :: BEGUM : ?

- (1) UEBGM                      (2) EUBGM  
(3) BGMEU                      (4) BGMUE

(SSC Combined Graduate Level Prelim  
Exam. 11.05.2003 (IInd Sitting))

**22.** DCHG : LKQP :: FEJI : ?

- (1) MLSR                      (2) NMRQ  
(3) ONTS                      (4) QPUT

(SSC CPO Sub-Inspector  
Exam. 07.09.2003)

**ANALOGY OR SIMILARITY**

- 23. CAD : FDG :: XZW : ?**  
 (1) IQJ (2) CAD  
 (3) ZBY (4) UWT  
 (SSC CPO Sub-Inspector Exam. 07.09.2003)
- 24. N U M B E R : U N B M R E :: GHOST : ?**  
 (1) HOGST (2) HOGTS  
 (3) HGSOT (4) HGOST  
 (SSC Combined Graduate Level Prelim Exam. 08.02.2004 (1st Sitting))
- 25. SKIP : RIFL :: KYKZ : ?**  
 (1) WJHV (2) WJVH  
 (3) JWVH (4) JWHV  
 (SSC Combined Graduate Level Prelim Exam. 08.02.2004 (1st Sitting))
- 26. HKNQ : GDAX :: SVYB : ?**  
 (1) TQMK (2) ROLI  
 (3) ZVTQ (4) ADGJ  
 (SSC Combined Graduate Level Prelim Exam. 08.02.2004 (1st Sitting))
- 27. REASON : SFBTPO :: THINK : ?**  
 (1) S G H M J (2) U I J O L  
 (3) U H N K I (4) U J K P M  
 (SSC Combined Graduate Level Prelim Exam. 08.02.2004 (IInd Sitting))
- 28. BCFE : HILK :: NORQ : ?**  
 (1) T X W U (2) T X U W  
 (3) T U X W (4) T V W X  
 (SSC Combined Graduate Level Prelim Exam. 08.02.2004 (IInd Sitting))
- 29. A Z B Y : C X D W :: E V F U : ?**  
 (1) G T H S (2) G H T S  
 (3) G S T H (4) T G S H  
 (SSC Combined Graduate Level Prelim Exam. 08.02.2004 (IInd Sitting))
- 30. ACEG : IKMO :: QSUW : ?**  
 (1) XBDF (2) MOQS  
 (3) YACE (4) BDFH  
 (SSC CPO Sub-Inspector Exam. 05.09.2004)
- 31. EHGI : LONP :: ? : ORQS**  
 (1) GJIK (2) GIHJ  
 (3) HKJL (4) HJIK  
 (SSC CPO Sub-Inspector Exam. 05.09.2004)
- 32. BEHK : YVSP :: CFIL : ?**  
 (1) XVSQ (2) XWUT  
 (3) XURO (4) XUSP  
 (SSC CPO Sub-Inspector Exam. 26.05.2005)
- 33. ADHM : ZWSN :: CFJO : ?**  
 (1) YVRM (2) WSPK  
 (3) XUQL (4) ZXVT  
 (SSC CPO Sub-Inspector Exam. 26.05.2005)
- 34. ACFJ : ZXUQ :: EGJN : ?**  
 (1) VUSQ (2) VTRP  
 (3) VRPM (4) VTQM  
 (SSC Statistical Investigators Grade-IV Exam. 31.07.2005)
- 35. M A S T E R : O C U V G T :: LABOUR : ?**  
 (1) NCDQWT (2) NDERWT  
 (3) NBCRWT (4) NEDRWT  
 (SSC Combined Graduate Level Prelim Exam. 13.11.2005 (1st Sitting))
- 36. ABCD : WXYZ :: EFGH : ?**  
 (1) STUV (2) ZYXW  
 (3) VUTS (4) WXZY  
 (SSC Combined Graduate Level Prelim Exam. 13.11.2005 (1st Sitting))
- 37. WRITE : JEVGR :: WRONG : ?**  
 (1) JEBAT (2) JECAT  
 (3) JEDAT (4) JEDAD  
 (SSC Combined Graduate Level Prelim Exam. 13.11.2005 (IInd Sitting))
- 38. EJOT : VQLG :: BGLQ : ?**  
 (1) ZUPK (2) AFKP  
 (3) AEIM (4) YTOJ  
 (SSC Combined Graduate Level Prelim Exam. 13.11.2005 (IInd Sitting))
- 39. DEAD : WVZW :: FGCF : ?**  
 (1) UTXU (2) TUUX  
 (3) UXTU (4) UUTX  
 (SSC Combined Graduate Level Prelim Exam. 13.11.2005 (IInd Sitting))
- 40. PCWL : REXM :: THNY : ?**  
 (1) OZPL (2) KOVZ  
 (3) PMKZ (4) VJOZ  
 (SSC Statistical Investigators Grade-IV Exam. 13.08.2006)
- 41. QPRS : TUWV :: JIKL : ?**  
 (1) NMOP (2) NMPO  
 (3) MNPO (4) MNOP  
 (SSC CPO Sub-Inspector Exam. 03.09.2006)
- 42. ACCE : EGGI :: IKKM : ?**  
 (1) MOOQ (2) NOOP  
 (3) MPPQ (4) NPPR  
 (SSC Combined Graduate Level Prelim Exam. 04.02.2007 (1st Sitting))
- 43. SRPQ : ONLM :: KJHI : ?**  
 (1) GEDF (2) GFED  
 (3) GFDC (4) GFDE  
 (SSC Combined Graduate Level Prelim Exam. 04.02.2007 (1st Sitting))
- 44. IKKL : JLLM :: SUUV : ?**  
 (1) FFGH (2) CEFE  
 (3) WXXZ (4) TVVW  
 (SSC Combined Graduate Level Prelim Exam. 04.02.2007 (IInd Sitting))
- 45. FIGUR : FGIRU :: STRES : ?**  
 (1) STERS (2) TRSES  
 (3) SRSET (4) SRTSE  
 (SSC Combined Graduate Level Prelim Exam. 04.02.2007 (IInd Sitting))
- 46. IJL : MNP :: ?**  
 (1) RSU : VXY (2) QRT : UVX  
 (3) KLN : QPR (4) GHI : JKO  
 (SSC CPO Sub-Inspector Exam. 16.12.2007)
- 47. AZYB : CXWD : EVUF : ?**  
 (1) GTSH (2) GSTH  
 (3) GSHT (4) GSPH  
 (SSC CPO Sub-Inspector Exam. 16.12.2007)
- 48. MAT : NCW :: APE : ?**  
 (1) CRH (2) BRH  
 (3) BSG (4) BSH  
 (SSC Combined Graduate Level Prelim Exam. 27.07.2008 (1st Sitting))
- 49. ADBC :: WZXY :: EHFG : ?**  
 (1) SVTU (2) STUV  
 (3) TUSV (4) STVU  
 (SSC Combined Graduate Level Prelim Exam. 27.07.2008 (1st Sitting))
- 50. KITCAT : CATTIK :: PENTOP : ?**  
 (1) TOPPEN (2) TOPNEP  
 (3) POPTEN (4) POPNET  
 (SSC Combined Graduate Level Prelim Exam. 27.07.2008 (1st Sitting))
- 51. LJH : KKI :: CIA : ?**  
 (1) BJB (2) BBC  
 (3) DBB (4) CBZ  
 (SSC Combined Graduate Level Prelim Exam. 27.07.2008 (IInd Sitting))
- 52. EGIK : FILO :: FHJL : ?**  
 (1) JGMP (2) JGPM  
 (3) GJPM (4) GJMP  
 (SSC Combined Graduate Level Prelim Exam. 27.07.2008 (IInd Sitting))
- 53. DRIVE : EIDRV :: BEGUM : ?**  
 (1) EUBGM (2) MGBEU  
 (3) BGMEU (4) UEBGM  
 (SSC Combined Graduate Level Prelim Exam. 27.07.2008 (IInd Sitting))

**ANALOGY OR SIMILARITY**

54. ADHM : ZWSN :: CFJO : ?

- (A) YVRM (2) WSPK  
(3) XWTP (4) ZXVT

(SSC Combined Graduate Level Prelim Exam. 27.07.2008 (IInd Sitting))

55. BYDW : FUHS :: AZCX : ?

- (1) EVGT (2) FVGT  
(3) EGVV (4) FGVV

(SSC CPO Sub-Inspector Exam. 09.11.2008)

56. BIRD : WIRY :: RAIN : ?

- (1) YRIW (2) NIAR  
(3) MRZI (4) QAIM

(SSC CPO Sub-Inspector Exam. 09.11.2008)

57. AYBZ : CWDX :: EUFV : ?

- (1) GSHT (2) GHST  
(3) SHGT (4) MVGT

(SSC CPO Sub-Inspector Exam. 06.09.2009)

58. DCEF : QPRS :: XWYZ : ?

- (1) IHGF (2) STUV  
(3) SRQP (4) NMOP

(SSC CPO Sub-Inspector Exam. 06.09.2009)

59. AZCX : BYDW :: HQJO : ?

- (1) GRFP (2) IPKM  
(3) IPKN (4) GRJP

(SSC Combined Graduate Level Tier-1 Exam. 16.05.2010 (IInd Sitting))

60. QIOK : MMKO :: YAWC : ?

- (1) USGA (2) UESG  
(3) VUES (4) SUEG

(SSC Combined Graduate Level Tier-1 Exam. 16.05.2010 (IInd Sitting))

61.  $\frac{ABC}{F} : \frac{BCD}{I} :: \frac{CDE}{L} : ?$

- (1)  $\frac{DEF}{O}$  (2)  $\frac{DEF}{N}$   
(3)  $\frac{EDF}{O}$  (4)  $\frac{DEF}{M}$

(SSC Combined Graduate Level Tier-1 Exam. 16.05.2010 (IInd Sitting))

62. EXCUSE : CXEESU :: ERODES : ?

- (1) OREESD (2) ORESED  
(3) REOSDE (4) ERODSE

(SSC SAS Exam. 26.06.2010 (Paper-I))

63. LJH : KKI :: CIA : ?

- (1) DBB (2) BJB  
(3) CBZ (4) BBZ

(SSC SAS Exam. 26.06.2010 (Paper-I))

64. CFDB : XUWY :: GJHF : ?

- (1) SPRT (2) TSQU  
(3) TQSU (4) SPTR

(SSC SAS Exam. 26.06.2010 (Paper-I))

65. KML : NPO :: CED : ?

- (1) EGF (2) GHF  
(3) FHG (4) HGF

(SSC CISF ASI Exam. 29.08.2010 (Paper-I))

66. ADGJ : MPSV :: ? : NQTW

- (1) BEHK (2) EHKM  
(3) DGJN (4) QTVZ

(SSC CISF ASI Exam. 29.08.2010 (Paper-I))

67. UPSET : SETUP :: TIPTOP : ?

- (1) TOTPOP (2) TOTPIP  
(3) TITPOP (4) TOPTIP

(SSC CISF ASI Exam. 29.08.2010 (Paper-I))

68. BYW : DWU :: FUS : ?

- (1) ESQ (2) GST  
(3) HSQ (4) EST

(SSC CPO Sub-Inspector Exam. 12.12.2010 (Paper-I))

69. JLNP : OMKI :: SUWY : ?

- (1) MLKI (2) PLHD  
(3) XVTR (4) PGHI

(SSC CPO Sub-Inspector Exam. 12.12.2010 (Paper-I))

70. NUMBER : UNBMRE :: GHOST : ?

- (1) HOGST (2) HOGTS  
(3) HGOTS (4) HGSOT

(SSC CPO Sub-Inspector Exam. 12.12.2010 (Paper-I))

71. CFIL : ORUX :: DGJM : ?

- (1) HJLN (2) NQST  
(3) PSVY (4) RTVX

(SSC Combined Graduate Level Prelim Exam. 19.06.2011 (Ist Sitting))

72. BEHK : YVSP :: DGJM : ?

- (1) JGDA (2) ROLI  
(3) WTQN (4) ZWTQ

(SSC Combined Graduate Level Prelim Exam. 19.06.2011 (Ist Sitting))

73. MKOO : LNPR :: ? : XVTZ

- (1) WYTS (2) SVWY  
(3) VTWY (4) YSUW

(SSC Combined Graduate Level Prelim Exam. 19.06.2011 (Ist Sitting))

74. TEKCAR : RACKET :: TCEJBO : ?

- (1) TCEOBJ (2) OBJECT  
(3) CEJBOT (4) REJECT

(SSC Combined Graduate Level Prelim Exam. 19.06.2011 (IInd Sitting))

75. JIHK : PONQ :: WVUX : ?

- (1) KNML (2) RSTU  
(3) HIGJ (4) MLKN

(SSC Combined Graduate Level Prelim Exam. 19.06.2011 (IInd Sitting))

76. UUWX : WWYZ :: OOQR : ?

- (1) OOPG (2) MMPQ  
(3) XXYZ (4) QQST

(SSC Combined Graduate Level Prelim Exam. 19.06.2011 (IInd Sitting))

77. BIMN : CKPR :: CURD : ?

- (1) DWUH (2) WUHC  
(3) UHDW (4) HUVN

(SSC Combined Graduate Level Prelim Exam. 19.06.2011 (IInd Sitting))

78. BCFE : HILK :: NORQ : ?

- (1) TXWU (2) TXUW  
(3) TUXW (4) TUWX

(SSC Combined Graduate Level Prelim Exam. 19.06.2011 (IInd Sitting))

79. NUMERAL : UEALRMN :: ALGEBRA : ?

- (1) LRBAGEA (2) BARLAGE  
(3) LERAGBA (4) LERABGA

(SSC Combined Graduate Level Tier-1 Exam. 26.06.2011 (Ist Sitting))

80. BDAC : FHEC :: NPMO : ?

- (1) RQTS (2) QTRC  
(3) TRQS (4) RTQS

(SSC Combined Graduate Level Tier-1 Exam. 26.06.2011 (Ist Sitting))

81. FGHI : OPQR :: BCDE : ?

- (1) KLMJ (2) KLMN  
(3) IUVW (4) STUW

(SSC Combined Graduate Level Tier-1 Exam. 26.06.2011 (Ist Sitting))

82. PNLJ : IGEC :: VTRP : ?

- (1) OMKI (2) RSTU  
(3) QSRC (4) RPOM

(SSC Combined Graduate Level Tier-1 Exam. 26.06.2011 (Ist Sitting))

83. LOCKER : KMNPDJLDFQS :: LEFT : ?

- (1) KNCDSGSU (2) KMDFEGSU  
(3) KMDFEGUS (4) KMDFEGUS

(SSC Combined Graduate Level Tier-1 Exam. 26.06.2011 (IInd Sitting))

84. YWUS : BDFH :: WUSQ : ?

- (1) DFHJ (2) FHJL  
(3) JLNP (4) RTVX

(SSC Combined Graduate Level Tier-1 Exam. 26.06.2011 (IInd Sitting))

85. ADCB : KNML :: EHGJ : ?

- (1) DGFE (2) RUST  
(3) QRST (4) ZYXW

(SSC Combined Graduate Level Tier-1 Exam. 26.06.2011 (IInd Sitting))

86. BCDF : GHIK :: LMNP : ?

- (1) QRST (2) QRTS  
(3) QRSU (4) QRSV

(SSC Combined Graduate Level Tier-1 Exam. 26.06.2011 (IInd Sitting))

**ANALOGY OR SIMILARITY**

**87. ABCD : WXYZ :: EFGH : ?**

- (1) STUV (2) ZYXW  
(3) VUTS (4) WXYZ

(SSC Combined Graduate Level Tier-1  
Exam. 26.06.2011 (IInd Sitting))

**88. RIDE: LNBE :: HELP: ?**

- (1) NINP (2) BAJP  
(3) JPCH (4) BJJP

(SSC CPO (SI, ASIn& Intelligence Officer)  
Exam. 28.08.2011 (Paper-I))

**89. BCDE : LMNO :: FGHI : ?**

- (1) RSTU (2) JKLM  
(3) HIJK (4) PQRS

(SSC Combined Matric Level (PRE)  
Exam.24.10.1999 (Ist Sitting))

**90. Earn : near :: reef : ?**

- (1) feer (2) free  
(3) fere (4) efre

(SSC Combined Matric Level (PRE)  
Exam.24.10.1999 (Ist Sitting))

**91. ACEG : BDFH :: CEGI : ?**

- (1) DFHJ (2) EGIK  
(3) EGIH (4) DHIK

(SSC Combined Matric Level (PRE)  
Exam.24.10.1999 (IInd Sitting))

**92. N U M B E R : U N B M R E :: GHOSTS : ?**

- (1) HGOSTS (2) HOGSTS  
(3) HGSOST (4) HGSOTS

(SSC Combined Matric Level (PRE)  
Exam.24.10.1999 (IInd Sitting))

**93. BDFH : CFIL :: EGIK : ?**

- (1) FHKN (2) FGKN  
(3) FILO (4) FLIO

(SSC Combined Matric Level (PRE)  
Exam. 21.05.2000 (Ist Sitting)  
(East Zone))

**94. HKNQ : ADGJ :: ORUX : ?**

- (1) ACEG (2) ADGH  
(3) MPSV (4) LMNO

(SSC Combined Matric Level (PRE)  
Exam. 21.05.2000 (Ist Sitting)  
(East Zone))

**95. BCD : QPO :: EFG : ?**

- (1) TSR (2) HIJ  
(3) SRT (4) JIH

(SSC Combined Matric Level (PRE) }  
Exam. 21.05.2000 (Ist Sitting)  
(East Zone)

**96. ABCD : HGFE :: OPQR : ?**

- (1) STUV (2) TUSV  
(3) VTSU (4) VUTS

(SSC Combined Matric Level (PRE)  
Exam.21.05.2000 (Ist Sitting)  
(Raipur, Madhya Pradesh))

**97. ABDE : HIKL :: NOQR : ?**

- (1) SUVX (2) UVXY  
(3) STUV (4) UWYZ

(SSC Combined Matric Level (PRE)  
Exam.21.05.2000 (Ist Sitting)  
(Raipur, Madhya Pradesh))

**98. BDFH : IKMO :: QSUW : ?**

- (1) GIKL (2) XZBD  
(3) OPQR (4) BDFG

(SSC Combined Matric Level (PRE)  
Exam. 21.05.2000 (Ist Sitting)  
(Middle Zone))

**99. CEGI : KMOQ :: SUWY : ?**

- (1) ACEG (2) ZBDF  
(3) MOQS (4) UWYA

(SSC Combined Matric Level (PRE)  
Exam. 21.05.2000 (Ist Sitting)  
(Middle Zone))

**100. ACF : PRU :: EGK : ?**

- (1) JMO (2) ZAD  
(3) OQT (4) UWA

(SSC Combined Matric Level (PRE)  
Exam. 21.05.2000 (IInd Sitting)  
(Middle Zone, Allahabad))

**101. GECA : BDFH :: PNLJ : ?**

- (1) KMOQ (2) RPNI  
(3) KNPR (4) JLNP

(SSC Combined Matric Level (PRE)  
Exam. 21.05.2000 (IInd Sitting)  
(Middle Zone, Allahabad))

**102. ABEF : IJMN :: CDGH : ?**

- (1) JKNP (2) KLNQ  
(3) JKMN (4) KLOP

(SSC Combined Matric Level (PRE)  
Exam. 21.05.2000 (IInd Sitting)  
(Middle Zone, Allahabad))

**103. acme : mace :: alga : ?**

- (1) glaa (2) gaal  
(3) laga (4) gala

(SSC Combined Matric Level (PRE)  
Exam.13.05.2001 (Ist Sitting))

**104. ate : tea :: top : ?**

- (1) pot (2) opt  
(3) tpo (4) pto

(SSC Combined Matric Level (PRE)  
Exam.13.05.2001 (IInd Sitting))

**105. item : mite :: ache : ?**

- (1) heac (2) heca  
(3) each (4) ceha

(SSC Combined Matric Level (PRE)  
Exam. 27.05.2001 (IInd Sitting)  
(East Zone))

**106. NATION : ANTINO :: HUNGRY : ?**

- (1) HNUGRY (2) UNHGYR  
(3) YRNGUH (4) UHNGYR

(SSC Combined Matric Level (PRE)  
Exam. 05.05.2002 (Ist Sitting)  
(Eastern Zone, Guwahati))

**107. BCDA : STUR :: KLMJ : ?**

- (1) VWXU (2) EFHG  
(3) SRTU (4) QSRP

(SSC Combined Matric Level (PRE)  
Exam. 05.05.2002 (IInd Sitting)  
(Eastern Zone, Guwahati))

**108. EIGHTY : GIEYTH :: OUTPUT : ?**

- (1) UTOPTU (2) UOTUPT  
(3) TUOUTP (4) TUOTUP

(SSC Combined Matric Level (PRE)  
Exam.05.05.2002 (Ist Sitting)  
(North Zone, Delhi))

**109. RUX : TRP :: BEH : ?**

- (1) SQN (2) QON  
(3) QOM (4) QNL

(SSC Combined Matric Level (Pre)  
Exam. 05.05.2002 (IInd Sitting)  
(North Zone Delhi))

**110. XZY : WVU :: CAB : ?**

- (1) UVW (2) ABC  
(3) FED (4) DEF

(SSC Combined Matric Level (Pre)  
Exam. 05.05.2002 (IInd Sitting)  
(North Zone Delhi))

**111. QPON : MLKJ :: XWVU : ?**

- (1) PQRS (2) TSRQ  
(3) SRQP (4) GFED

(SSC Combined Matric Level (Pre)  
Exam. 12.05.2002 (Ist Sitting))

**112. NOPQ : MLKJ :: HIJK : ?**

- (1) GFED (2) EFGH  
(3) DEFG (4) FEDC

(SSC Combined Matric Level (Pre)  
Exam. 12.05.2002 (IInd Sitting))

**113. Bat : Cat :: ? : Fat**

- (1) Eat (2) Mat  
(3) Pat (4) Hat

(SSC Combined Matric Level (Pre)  
Exam.16.06.2002 (Re-Exam))

**114. DumB : BonD :: RusT : ?**

- (1) MOst (2) TeNt  
(3) PaTH (4) WorK

(SSC Combined Matric Level (Pre)  
Exam.16.06.2002 (Re-Exam))

**115. LNPR : TUXZ :: NPRT : ?**

- (1) FHJL (2) FLJH  
(3) HFLJ (4) JLHF

(SSC Combined Matric Level (Pre)  
Exam.16.06.2002 (Re-Exam))

**116. DEVIL : LIVED :: STRAP : ?**

- (1) PRATS (2) PARTS  
(3) TRAPS (4) SPART

(SSC Combined Matric Level (Pre)  
Exam.30.07.2006 (Ist Sitting)  
(East Zone))

**117. HOUSE : GNTRD :: ? : KHFGS**

- (1) SIGHT (2) FIGHT  
(3) MIGHT (4) LIGHT

(SSC Combined Matric Level (Pre)  
Exam.30.07.2006 (Ist Sitting)  
(East Zone))

**ANALOGY OR SIMILARITY**

- 118. METAPHOR : EMATHPRO :: NORMAL : ?**  
 (1) ORMLAN (2) ONRMLA  
 (3) ONMRLA (4) ONMRAL  
 SSC Combined Matric Level (Pre)  
 Exam.30.07.2006 (1st Sitting)  
 (East Zone)
- 119. WOLF : FLOW :: WARD : ?**  
 (1) BROW (2) DRAW  
 (3) CRAW (4) SLAW  
 SSC Combined Matric Level (Pre)  
 Exam.30.07.2006 (IIInd Sitting)  
 (Central Zone)
- 120. GRAIN : TIZRM :: BRAIN : ?**  
 (1) XRIKL (2) YIZRM  
 (3) OPRST (4) ASQMI  
 SSC Combined Matric Level (Pre)  
 Exam.30.07.2006 (IIInd Sitting)  
 (Central Zone)
- 121. CUT : BDTVSU :: TIP : ?**  
 (1) UVHJOQ (2) SUHJOQ  
 (3) USJHQO (4) SUJHQO  
 SSC Combined Matric Level (Pre)  
 Exam.30.07.2006 (IIInd Sitting)  
 (Central Zone)
- 122. AC : CF :: MO : ?**  
 (1) OQ (2) PQ  
 (3) QR (4) OR  
 SSC Combined Matric Level (Pre)  
 Exam. 30.03.2008 (1st Sitting)
- 123. BCD : GFE :: HIJ : ?**  
 (1) KLM (2) MLK  
 (3) MKL (4) LMK  
 SSC Combined Matric Level (Pre)  
 Exam. 30.03.2008 (1st Sitting)
- 124. OPRS : TUUV :: JIKL : ?**  
 (1) NMOP (2) NMPO  
 (3) MNPO (4) MNOP  
 SSC Combined Matric Level (Pre)  
 Exam. 30.03.2008 (1st Sitting)
- 125. AZBY : CXDW :: HSIR : ?**  
 (1) JQKP (2) KPLO  
 (3) YBXC (4) TGSH  
 SSC Data Entry Operator  
 Exam. 31.08.2008
- 126. DMVE : ? :: HQZI : JSBK**  
 (1) GOXF (2) FOXG  
 (3) GOXG (4) FNWG  
 SSC Data Entry Operator  
 Exam. 31.08.2008
- 127. AN : BO :: LY : ?**  
 (1) MN (2) JW  
 (3) MZ (4) IV  
 SSC Data Entry Operator  
 Exam. 02.08.2009
- 128. ACE : HIL :: MOQ : ?**  
 (1) TVX (2) TUX  
 (3) XVT (4) SUW  
 SSC DEO Exam. 02.08.2009

- 129. BDFH : JLNP :: RTVX : ?**  
 (1) BDHF (2) BDFZ  
 (3) ZBDF (4) YZAB  
 SSC Data Entry Operator  
 Exam. 02.08.2009
- 130. NLO : RPS :: VTW : ?**  
 (1) X V Y (2) V T R  
 (3) T R P (4) V U W  
 SSC Stenographer (Grade'C & D')  
 Exam. 26.09.2010
- 131. BELL : AFKM :: DOOR : ?**  
 (1) CNPQ (2) ENPS  
 (3) EPNS (4) CPNS  
 SSC Stenographer (Grade'C & D')  
 Exam. 26.09.2010
- 132. JLNP : OMKI :: SUWY : ?**  
 (1) MLKJ (2) PLHD  
 (3) XVTR (4) FGHI  
 SSC Stenographer (Grade'C & D')  
 Exam. 26.09.2010
- 133. VXZ : JLN :: GIK : ?**  
 (1) QSO (2) QRS  
 (3) OQS (4) LMO  
 (SSC Higher Secondary Level  
 Data Entry Operator & LDC  
 Exam.27.11.2010)
- 134. ABZY : CDXW :: EFVU : ?**  
 (1) IJRQ (2) KLPO  
 (3) MNST (4) GHST  
 (SSC Higher Secondary Level  
 Data Entry Operator & LDC  
 Exam.27.11.2010)
- 135. NUMBER : UNBMRE :: GHOST : ?**  
 (1) HOGST (2) HOGTS  
 (3) HGOTS (4) HGSOT  
 (SSC Higher Secondary Level  
 Data Entry Operator & LDC  
 Exam.27.11.2010)
- 136. UNDATED : ATEDUND :: CORRECT : ?**  
 (1) PRECTOC (2) RECTROC  
 (3) ECTRORC (4) RECTCOR  
 (SSC Higher Secondary Level  
 Data Entry Operator & LDC  
 Exam. 28.11.2010 (1st sitting))
- 137. AEHN : BGKR :: DFGN : ?**  
 (1) EHJR (2) EIJR  
 (3) EHKQ (4) DHKQ  
 (SSC Higher Secondary Level  
 Data Entry Operator & LDC  
 Exam. 28.11.2010 (1st sitting))
- 138. NJMP : PLOR :: RTVX : ?**  
 (1) VTXZ (2) TVXZ  
 (3) TVZX (4) SVZX  
 (SSC Higher Secondary Level  
 Data Entry Operator & LDC  
 Exam. 28.11.2010 (1st sitting))

- 139. CHAIR : RIAHC :: TABLE : ?**  
 (1) BATLE (2) EBATL  
 (3) ELBAT (4) ELTAB  
 (SSC Higher Secondary Level  
 Data Entry Operator & LDC  
 Exam. 28.11.2010 (IIInd sitting))
- 140. LKJ : MNO :: DCB : ?**  
 (1) FEG (2) EGF  
 (3) FGH (4) EFG  
 (SSC Higher Secondary Level  
 Data Entry Operator & LDC  
 Exam. 28.11.2010 (IIInd sitting))
- 141. ABCD : WXYZ :: EFGH : ?**  
 (1) STUV (2) STOU  
 (3) STUE (4) TSUV  
 (SSC Higher Secondary Level  
 Data Entry Operator & LDC  
 Exam. 28.11.2010 (IIInd sitting))
- 142. FLRX : EJOT :: CKTY : ?**  
 (1) BIQV (2) DIPO  
 (3) DHOU (4) BIQU  
 (SSC Stenographer Grade 'C' & 'D'  
 Exam. 09.01.2011)
- 143. BEHK : YVSP :: ADGJ : ?**  
 (1) ZUTR (2) ZVSP  
 (3) ZWTQ (4) ZWXZ  
 (SSC Stenographer Grade 'C' & 'D'  
 Exam. 09.01.2011)
- 144. AGMS : CIOU :: DJPV : ?**  
 (1) BHNY (2) STUV  
 (3) FLRX (4) MNOP  
 (SSC Multi-Tasking (Non-Technical)  
 Staff Exam. 20.02.2011)
- 145. CAT : DDY :: BIG : ?**  
 (1) CLL (2) CLM  
 (3) CML (4) CEP  
 (SSC Multi-Tasking (Non-Technical)  
 Staff Exam. 20.02.2011)
- 146. KMF : LLH :: RMS : ?**  
 (1) SLR (2) SLU  
 (3) SSU (4) SUS  
 (SSC Multi-Tasking (Non-Technical)  
 Staff Exam. 27.02.2011)
- 147. CEGI : RTVX :: IKMO : ?**  
 (1) JKLNP (2) LNPR  
 (3) MNPO (4) DFHI  
 (SSC Multi-Tasking (Non-Technical)  
 Staff Exam. 27.02.2011)
- 148. ACDF : MOPR :: TVWY : ?**  
 (1) LNPR (2) PRSU  
 (3) STVW (4) RUWZ  
 (SSC CISF Constable (GD)  
 Exam. 05.06.2011)
- 149. BDFH : JLNP :: ? : KMOQ**  
 (1) HIJK (2) CEGI  
 (3) EGJL (4) CFGI  
 (SSC Stenographer (Grade 'C' & 'D')  
 Exam. 16.10.2011)

**ANALOGY OR SIMILARITY**

- 150. DAM : MAD :: WARD : ?**  
 (1) DWAR (2) DWOR  
 (3) DRAW (4) DROW  
 (SSC Stenographer (Grade 'C' & 'D')  
 Exam. 16.10.2011)
- 151. AL : CN :: DA : ?**  
 (1) BL (2) AA  
 (3) HR (4) FC  
 SSC (10+2) Level Data Entry  
 Operator & LDC Exam. 04.12.2011  
 (Ist Sitting (North Zone))
- 152. ABC : ZYX :: CBA : ?**  
 (1) XYZ (2) BCA  
 (3) YZX (4) XZY  
 SSC (10+2) Level Data Entry  
 Operator & LDC Exam. 04.12.2011  
 (Ist Sitting (North Zone))
- 153. AZBY : ZAYB :: CXDW : ?**  
 (1) AYBZ (2) EVFU  
 (3) BYAZ (4) XCWD  
 SSC (10+2) Level Data Entry  
 Operator & LDC Exam. 04.12.2011  
 (Ist Sitting (North Zone))
- 154. BC : DI :: DE : ?**  
 (1) PY (2) FP  
 (3) EI (4) RU  
 SSC (10+2) Level Data Entry  
 Operator & LDC Exam. 04.12.2011  
 (IInd Sitting (North Zone))
- 155. ACE : KIG :: MOQ : ?**  
 (1) WUS (2) WVU  
 (3) WVT (4) WUT  
 SSC (10+2) Level Data Entry  
 Operator & LDC Exam. 04.12.2011  
 (IInd Sitting (North Zone))
- 156. DCEF : WXVU :: KJLM : ?**  
 (1) QPRS (2) STRQ  
 (3) PQNO (4) NMKL  
 SSC (10+2) Level Data Entry  
 Operator & LDC Exam. 04.12.2011  
 (IInd Sitting (North Zone))
- 157. BD : CI :: DP : ?**  
 (1) EZ (2) EY  
 (3) DF (4) EX  
 SSC (10+2) Level Data Entry  
 Operator & LDC Exam. 04.12.2011  
 (Ist Sitting (East Zone))
- 158. ACE : GIK :: MOQ : ?**  
 (1) SUW (2) STU  
 (3) STW (4) SVW  
 SSC (10+2) Level Data Entry  
 Operator & LDC Exam. 04.12.2011  
 (Ist Sitting (East Zone))
- 159. EGIK : LJHF :: SUWY : ?**  
 (1) ZXVT (2) LNPR  
 (3) MOQS (4) TVXZ  
 SSC (10+2) Level Data Entry  
 Operator & LDC Exam. 04.12.2011  
 (Ist Sitting (East Zone))

- 160. RT : WZ :: PR : ?**  
 (1) UX (2) TU  
 (3) RV (4) XU  
 SSC (10+2) Level Data Entry  
 Operator & LDC Exam. 04.12.2011  
 (IInd Sitting (East Zone))
- 161. ACF : JLO :: UWZ : ?**  
 (1) CEG (2) MOP  
 (3) QRV (4) GIL  
 SSC (10+2) Level Data Entry  
 Operator & LDC Exam. 04.12.2011  
 (IInd Sitting (East Zone))
- 162. BDGH : OQTU :: FHKL : ?**  
 (1) JKLM (2) BCDE  
 (3) SUXY (4) WXYZ  
 SSC (10+2) Level Data Entry  
 Operator & LDC Exam. 04.12.2011  
 (IInd Sitting (East Zone))
- 163. AN : BO :: CP : ?**  
 (1) DQ (2) FS  
 (3) DS (4) FQ  
 SSC (10+2) Level Data Entry  
 Operator & LDC Exam. 11.12.2011  
 (Ist Sitting (Delhi Zone))
- 164. DDW : ECV :: FBU : ?**  
 (1) GAW (2) GAV  
 (3) VAG (4) GAT  
 SSC (10+2) Level Data Entry  
 Operator & LDC Exam. 11.12.2011  
 (Ist Sitting (Delhi Zone))
- 165. BCDZ : CDEV :: DEFT : ?**  
 (1) FFGQ (2) EGFR  
 (3) EFGP (4) EFGS  
 SSC (10+2) Level Data Entry  
 Operator & LDC Exam. 11.12.2011  
 (Ist Sitting (Delhi Zone))
- 166. LO : PK :: IR : ?**  
 (1) GT (2) SH  
 (3) MN (4) FU  
 SSC (10+2) Level Data Entry  
 Operator & LDC Exam. 11.12.2011  
 (IInd Sitting (Delhi Zone))
- 167. QTU : ILM :: BEF : ?**  
 (1) PSZ (2) CFH  
 (3) WZA (4) UXB  
 SSC (10+2) Level Data Entry  
 Operator & LDC Exam. 11.12.2011  
 (IInd Sitting (Delhi Zone))
- 168. ACEG : ZXVT :: HJLM : ?**  
 (1) QOMK (2) SRPO  
 (3) RPNL (4) SQON  
 SSC (10+2) Level Data Entry  
 Operator & LDC Exam. 11.12.2011  
 (IInd Sitting (Delhi Zone))

- 169. AD : NQ :: EH : ?**  
 (1) RT (2) RU  
 (3) RS (4) RV  
 SSC (10+2) Level Data Entry  
 Operator & LDC Exam. 11.12.2011  
 (Ist Sitting (East Zone))
- 170. AZB : BYC :: MVN : ?**  
 (1) NUO (2) NVO  
 (3) NVQ (4) NRO  
 SSC (10+2) Level Data Entry  
 Operator & LDC Exam. 11.12.2011  
 (Ist Sitting (East Zone))
- 171. BEHI : JMPQ :: KNQR : ?**  
 (1) SUXY (2) RUXY  
 (3) RVXY (4) RUYX  
 SSC (10+2) Level Data Entry  
 Operator & LDC Exam. 11.12.2011  
 (Ist Sitting (East Zone))
- 172. ACFJ : ZXUQ :: DFIM : ?**  
 (1) WURN (2) WURP  
 (3) WUQO (4) WTQP  
 SSC (10+2) Level Data Entry  
 Operator & LDC Exam. 11.12.2011  
 (IInd Sitting (East Zone))
- 173. EFI : IJL :: KLO : ?**  
 (1) OPR (2) PQS  
 (3) OPS (4) OPW  
 SSC (10+2) Level Data Entry  
 Operator & LDC Exam. 11.12.2011  
 (IInd Sitting (East Zone))
- 174. ZA : YB :: XC : ?**  
 (1) YZ (2) BC  
 (3) OP (4) WD  
 SSC (10+2) Level Data Entry  
 Operator & LDC Exam. 11.12.2011  
 (IInd Sitting (East Zone0))
- 175. EFG : IJK :: MNO : ?**  
 (1) PQR (2) OPQ  
 (3) QRS (4) NOP  
 SSC Constable (GD) & Rifleman (GD)  
 Exam. 22.04.2012 (Ist Sitting)
- 176. RAT : TAR :: PIT : ?**  
 (1) BIT (2) CAT  
 (3) TIP (4) TOP  
 SSC Constable (GD) & Rifleman (GD)  
 Exam. 22.04.2012 (IInd Sitting)
- 177. Rig : Ofd :: Met : ?**  
 (1) Jcr (2) Kbr  
 (3) Jbr (4) Kcr  
 (SSC Level Data Entry Operator &  
 LDC Exam. 21.10.2012 (Ist Sitting))
- 178. BDAC : FHEG :: NPMO : ?**  
 (1) RTQS (2) TRQS  
 (3) RQTS (4) QTRS  
 (SSC Level Data Entry Operator &  
 LDC Exam. 21.10.2012 (Ist Sitting))

**ANALOGY OR SIMILARITY**

- 179. SHOE : NCJZ :: REWA : ?**  
 (1) MZRV (2) CAAR  
 (G) WJBF (4) CITY  
 (SSC Level Data Entry Operator & LDC Exam. 21.10.2012 (1st Sitting))
- 180. QYGO : SAIQ :: UCKS : ?**  
 (1) VFNU (2) WEMU  
 (3) WDMV (4) WDLU  
 (SSC Level Data Entry Operator & LDC Exam. 21.10.2012 (IInd Sitting))
- 181. AZBZ : CYDY :: EXFX : ?**  
 (1) FWFV (2) GWHW  
 (3) IVJW (4) HWIW  
 (SSC Level Data Entry Operator & LDC Exam. 21.10.2012 (IInd Sitting))
- 182. CHAIR : RIAHC :: TABLE : ?**  
 (1) UBCMF (2) ELTAB  
 (3) ELBAT (4) SJBID  
 (SSC Level Data Entry Operator & LDC Exam. 21.10.2012 (IInd Sitting))
- 183. DHPV : EGQU :: BJNT : ?**  
 (1) CIOS (2) CHMR  
 (3) CGPU (4) CKPU  
 (SSC Level Data Entry Operator & LDC Exam. 28.10.2012 (1st Sitting))
- 184. xxyzzy : ccbabb :: xyzyzy :**  
 (1) abbacc (2) bbacca  
 (3) abbcca (4) cbbaab  
 (SSC Level Data Entry Operator & LDC Exam. 28.10.2012 (1st Sitting))
- 185. SHI : RIJ :: QJK : ?**  
 (1) TDE (2) PKL  
 (3) UGH (4) VPQ  
 (SSC Level Data Entry Operator & LDC Exam. 04.11.2012 (IInd Sitting))
- 186. BEHK : PSVY :: ADGJ : ?**  
 (1) KMOR (2) DHLP  
 (3) PRTV (4) MPSV  
 (SSC Level Data Entry Operator & LDC Exam. 04.11.2012 (IInd Sitting))
- 187. DEVIL : ABSFI :: OTHER : ?**  
 (1) MRFCP (2) RWKHU  
 (3) LQEBO (4) LRECO  
 (SSC Graduate Level Tier-I Exam. 11.11.2012 (1st Sitting))
- 188. AFKP : ZUPK :: BGLQ : ?**  
 (1) XSNI (2) YTOJ  
 (3) ZVOM (4) WRMH  
 (SSC Assistant Grade-III Exam. 11.11.2012 (IInd Sitting))
- 189. ABZ : BDX :: CFV : ?**  
 (1) HIT (2) DHI  
 (3) DHO (4) DHT  
 (FCI Assistant Grade-II Exam. 22.01.2012 Paper-I)

- 190. BCDE : VWXY :: FGHI : ?**  
 (1) JKLM (2) KLIJ  
 (3) NOPO (4) RSTU  
 (FCI Assistant Grade-II Exam. 22.01.2012 Paper-I)
- 191. LOM : NMK :: PKI : ?**  
 (1) RIH (2) SHG  
 (3) RIG (4) RHG  
 (FCI Assistant Grade-III Exam. 25.02.2012 (Paper-I) North Zone (1st Sitting))
- 192. JTIS : HRGQ :: FPEO : ?**  
 (1) DNCM (2) DCNQ  
 (3) CNDM (4) CNDQ  
 (FCI Assistant Grade-III Exam. 25.02.2012 (Paper-I) North Zone (1st Sitting))
- 193. BAD : CBE :: ? : IVSU**  
 (1) GOOD (2) HSPR  
 (3) HALT (4) HURT  
 (FCI Assistant Grade-III Exam. 25.02.2012 (Paper-I) North Zone (1st Sitting))
- 194. JLJH : OOQS :: FHFQ : ?**  
 (1) VWVS (2) VWUS  
 (3) USUW (4) USUV  
 (FCI Assistant Grade-III Exam. 05.02.2012 (Paper-I) East Zone (IInd Sitting))
- 195. CDE : ZXY :: EDC : ?**  
 (1) XYZ (2) YXZ  
 (3) XZY (4) YZX  
 (FCI Assistant Grade-III Exam. 05.02.2012 (Paper-I) East Zone (IInd Sitting))
- 196. MUG : GUM :: LENS : ?**  
 (1) GLASS (2) SPECTACLE  
 (3) SNEL (4) OBJECT  
 (FCI Assistant Grade-III Exam. 05.02.2012 (Paper-I) East Zone (IInd Sitting))
- 197. AB : L :: BC : ?**  
 (1) X (2) V  
 (3) Y (4) W  
 (SSC (10+2) Level Data Entry Operator & LDC Exam. 04.11.2012, 1st Sitting)
- 198. BDGJ : OQTW :: AFIM :**  
 (1) MUSY (2) MRUY  
 (3) NSVZ (4) NRZV  
 (SSC (10+2) Level Data Entry Operator & LDC Exam. 04.11.2012, 1st Sitting)
- 199. ABCD : QRST :: BACD : ?**  
 (1) RQST (2) STQR  
 (3) QRST (4) RSTQ  
 (SSC Multi-Tasking Staff Exam. 17.03.2013, Kolkata Region)

- 200. BGEK : YTVP :: AFEJ : ?**  
 (1) UZBK (2) BGFK  
 (3) ZUVQ (4) ZEDI  
 (SSC Multi-Tasking Staff Exam. 17.03.2013, Kolkata Region)
- 201. ABCD : EFGH :: IJKL : ?**  
 (1) OPQR (2) UVWX  
 (3) MNPO (4) NOPO  
 (SSC Multi-Tasking Staff Exam. 17.03.2013, Kolkata Region)
- 202. HCM : FAK :: SGD : ?**  
 (1) ESQ (2) GES  
 (3) QEB (4) QIB  
 (SSC Graduate Level Tier-I Exam. 21.04.2013, 1st Sitting)
- 203. FILM : ADGH :: MILK : ?**  
 (1) HDGE (2) HDGF  
 (3) HEGF (4) ADGF  
 (SSC Graduate Level Tier-I Exam. 21.04.2013, 1st Sitting)
- 204. A H O P : C K S U :: B J M F : ?**  
 (1) D Q K M (2) C J W M  
 (3) E Z U Q (4) D M Q K  
 (SSC Graduate Level Tier-I Exam. 21.04.2013, 1st Sitting)
- 205. A-E : R-V :: B-F : F - J**  
 (1) BSCG (2) FUGK  
 (2) CSCG (4) CTDH  
 (SSC Graduate Level Tier-I Exam. 21.04.2013, 1st Sitting)
- 206. BJCI : JBIC :: CXDW : ?**  
 (1) JCDU (2) BCJU  
 (3) EVFU (4) XCWD  
 (SSC Graduate Level Tier-I Exam. 21.04.2013, IInd Sitting)
- 207. AB : NO :: LM : ?**  
 (1) OL (2) KP  
 (3) PK (4) YZ  
 (SSC Graduate Level Tier-I Exam. 21.04.2013, IInd Sitting)
- 208. AG : IO :: EK : ?**  
 (1) LR (2) MS  
 (3) PV (4) SY  
 (SSC Graduate Level Tier-I Exam. 21.04.2013, IInd Sitting)
- 209. ACF : GIL :: MOR : ?**  
 (1) SUX (2) TUX  
 (3) UWZ (4) SVY  
 (SSC Constable (GD) Exam. 12.05.2013 1st Sitting)
- 210. XZG : CAT :: DOG : ?**  
 (1) TIW (2) GAD  
 (3) OWT (4) WLT  
 (SSC Graduate Level Tier-I Exam. 19.05.2013, 1st Sitting)

**ANALOGY OR SIMILARITY**

- 211. CARD : IGXJ :: POST : ?**  
 (1) UTXY (2) VUYZ  
 (3) UTYZ (4) VUXY  
 (SSC Graduate Level Tier-I Exam. 19.05.2013, IInd Sitting)
- 212. MOUSE : KPSTC :: LIGHT : ?**  
 (1) MJHIU (2) MGHFU  
 (3) JGEFR (4) JJEIR  
 (SSC Graduate Level Tier-I Exam. 19.05.2013, Ist Sitting)
- 213. ADHM : ZUQN :: GIKM : ?**  
 (1) NOQS (2) TORN  
 (3) TRPN (4) TNRP  
 (SSC CAPFs SI & CISF ASI Exam. 23.06.2013)
- 214. HAND : JBPE :: PALM : ?**  
 (1) RBNM (2) RBMN  
 (3) QBNN (4) RBNN  
 (SSC CAPFs SI & CISF ASI Exam. 23.06.2013)
- 215. AZ : BY :: DW : ?**  
 (1) EV (2) CX  
 (3) EX (4) CV  
 (SSC Cabinet Secretariat RO (ECO), DFO (T) & DFO (GD) Tier-I Exam. 23.06.2013)
- 216. ABC : XYZ :: DEF : ?**  
 (1) UVW (2) PQR  
 (3) HIJ (4) KLM  
 (SSC Cabinet Secretariat RO (ECO), DFO (T) & DFO (GD) Tier-I Exam. 23.06.2013)
- 217. FEDCBA : RQPONM :: LKJIHG : ?**  
 (1) ABCDEF (2) MNOPQR  
 (3) STUVWX (4) XWVUTS  
 (SSC Cabinet Secretariat RO (ECO), DFO (T) & DFO (GD) Tier-I Exam. 23.06.2013)
- 218. ABC : RQP :: CBA : ?**  
 (1) QRP (2) PRQ  
 (3) PQR (4) RPQ  
 (SSC Multi-Tasking (Non-Tech.) Staff Exam. 16.02.2014)
- 219. ACE : BDF :: MOQ : ?**  
 (1) BMW (2) NQP  
 (3) NPR (4) BEF  
 (SSC Multi-Tasking Staff (Patna) Exam. 16.02.2014)
- 220. BFG : EIJ :: RVW : ?**  
 (1) UWY (2) UYZ  
 (3) SWX (4) QUV  
 (SSC Multi-Tasking (Non-Tech.) Staff Exam. 23.02.2014, IInd Sitting)
- 221. BED : GJI :: LON : ?**  
 (1) QTS (2) PTS  
 (3) QST (4) KNH  
 (SSC CGL Tier-I Re-Exam-2013, 27.04.2014)

- 222. CDGF : HILK :: NORQ : ?**  
 (1) UVWY (2) PQTS  
 (3) STWX (4) IGNL  
 (SSC CGL Tier-I Re-Exam-2013, 27.04.2014)
- 223. KMNP : ACDF :: PRSU : ?**  
 (1) STVW (2) TVWY  
 (3) VXYZ (4) LNPR  
 (SSC CGL Tier-I Re-Exam-2013, 27.04.2014)
- 224. AB : ZY :: CD : ?**  
 (1) WX (2) UV  
 (3) XW (4) VU  
 (SSC CGL Tier-I Re-Exam-2013, 27.04.2014 & Bihar SSC 2nd Graduate Level (Pre) Exam-16.02.2015)
- 225. FLOWER : REWOLF : FRUITS : ?**  
 (1) STUIRF (2) STIURF  
 (3) STUIFR (4) STRUIF  
 (SSC CGL Tier-I Re-Exam-2013, 27.04.2014 & Bihar SSC 2nd Graduate Level (Pre) Exam-23.02.2015)
- 226. AFKP : DINS :: WBGL % ?**  
 (1) ORUX (2) OSWA  
 (3) OTYD (4) OQSU  
 (SSC CAPFs SI, CISF ASI & Delhi Police SI Exam. 22.06.2014)
- 227. SINGER : QGLECP :: MONSTER % ?**  
 (1) KLNSCP (2) KLMSCP  
 (3) KMLRCP (4) KLMTDO  
 (SSC CAPFs SI, CISF ASI & Delhi Police SI Exam. 22.06.2014)
- 228. BDAC : FHEG :: NPMO : ?**  
 (1) RTQS (2) QTRS  
 (3) RQTS (4) SQRT  
 (SSC CAPFs SI, CISF ASI & Delhi Police SI Exam. 22.06.2014)
- 229. BOMBAY : CNNABX :: ? : DM-MBLY**  
 (1) CNCLBZ (2) CNLCAZ  
 (3) CNLCBX (4) CNLCKZ  
 (SSC CAPFs SI, CISF ASI & Delhi Police SI Exam. 22.06.2014)
- 230. VOHA : WPIB :: CJQX : ?**  
 (1) DKRY (2) YRKD  
 (3) RKDY (4) YDKR  
 (SSC GL Tier-I Re-Exam. (2013) 20.07.2014, Ist Sitting)
- 231. PRINTING : RPNITGN :: PROTOCOL : ?**  
 (1) RPTOCOL (2) RPOTCOLO  
 (3) PRTOOCOL (4) RPTOCOLO  
 (SSC GL Tier-I Re-Exam. (2013) 20.07.2014, Ist Sitting)

- 232. AFKP : BGLO :: CHMR : ?**  
 (1) DINS (2) DFKP  
 (3) DNIS (4) EJOT  
 (SSC GL Tier-I Re-Exam. (2013) 20.07.2014, IInd Sitting)
- 233. PREMONITION : MONITIONERP :: LINSEEDOIL : ?**  
 (1) SEEDOILNLI  
 (2) SEEDOILLIN  
 (3) SEEDOILNIL  
 (4) SEEDOILILN  
 (SSC GL Tier-I Re-Exam. (2013) 20.07.2014, IInd Sitting)
- 234. SOCIAL : OCIALS :: DRIVEN : ?**  
 (1) VENRID (2) NEVIRD  
 (3) RIVEND (4) VIREND  
 (SSC GL Tier-I Exam. 19.10.2014, Ist Sitting)
- 235. AYRRJC : CATTLE : NCPDCAR : ?**  
 (1) SUBJECT (2) NEGLECT  
 (3) PERFECT (4) OPERATE  
 (SSC GL Tier-I Exam. 19.10.2014, Ist Sitting)
- 236. RIAHC : CHAIR :: OGNAM : ?**  
 (1) OGNMA (2) TANGO  
 (3) MANGO (4) ANGMO  
 (SSC GL Tier-I Exam. 19.10.2014)
- 237. PNS : OOT :: DBH : ?**  
 (1) PPI (2) BBI  
 (3) CCI (4) DDB  
 (SSC GL Tier-I Exam. 19.10.2014)
- 238. DLIP : FNKR :: JROV : ?**  
 (1) MURY (2) LTQX  
 (3) NVSZ (4) KSPW  
 (SSC GL Tier-I Exam. 26.10.2014)
- 239. YAWC : UESG :: QIOK : ?**  
 (1) MMKO (2) KOME  
 (3) MINC (4) MIKE  
 (SSC GL Tier-I Exam. 26.10.2014)
- 240. LJHF : USQO :: QOMK : ?**  
 (1) QPSR (2) PNMK  
 (3) VTRP (4) YXWU  
 (SSC CHSL (10+2) DEO & LDC Exam. 02.11.2014, Patna Region : Ist Sitting)
- 241. COUNTRY : FRXQWUB :: EXAMINE : ?**  
 (1) HAPDLQH (2) HADPLQH  
 (3) HAHPLDQ (4) GBQDVWB  
 (SSC CHSL (10+2) DEO & LDC Exam. 02.11.2014, Patna Region : Ist Sitting)

**ANALOGY OR SIMILARITY**

- 242. MONEY : YENOM :: RIGHT : ?**  
 (1) HTIRG (2) THGIR  
 (3) GIRHT (4) IRGHT  
 (SSC CHSL (10+2) DEO & LDC Exam. 02.11.2014, IInd Sitting)
- 243. NIILUSL : ILLUSION :: TBERVARE : ?**  
 (1) STRANGE (2) VERTEBRA  
 (3) VABTERE (4) ERAVEBT  
 (SSC CHSL (10+2) DEO & LDC Exam. 02.11.2014, IInd Sitting)
- 244. DEF : EFD :: FGH : ?**  
 (1) FHG (2) HGF  
 (3) HFG (4) GHF  
 (SSC CHSL (10+2) DEO & LDC Exam. 09.11.2014)
- 245. AZB : CYD :: EXF : ?**  
 (1) GWH (2) FGV  
 (3) TMR (4) QSV  
 (SSC CHSL (10+2) DEO & LDC Exam. 09.11.2014)
- 246. HGUOR : HTOOMS :: ? : REDNET**  
 (1) TOUGH (2) THOUG  
 (3) HUGOT (4) HGUOT  
 (SSC CHSL (10+2) DEO & LDC Exam. 09.11.2014)
- 247. ZX : AC :: VT : ?**  
 (1) EG (2) DF  
 (3) AB (4) AE  
 (SSC CHSL (10+2) DEO & LDC Exam. 16.11.2014, Patna Region : Ist Sitting)
- 248. ABCXYZ : DEFUVW :: GHIRST : ?**  
 (1) JNOPKL (2) MNOLKJ  
 (3) JKLOPQ (4) JOKPLN  
 (SSC CHSL (10+2) DEO & LDC Exam. 16.11.2014, Patna Region : Ist Sitting)
- 249. ACE : BDF :: MOQ : ?**  
 (1) NPR (2) NZV  
 (3) MZU (4) MVT  
 (SSC CHSL (10+2) DEO & LDC Exam. 16.11.2014, Patna Region : Ist Sitting)
- 250. VZS : EAH :: ? : JFM**  
 (1) QSM (2) NUQ  
 (3) QUN (4) QNU  
 (SSC CHSL (10+2) DEO & LDC Exam. 16.11.2014)
- 251. HJLN : PRTV :: BDFH : ?**  
 (1) JMOR (2) JLNP  
 (3) KLOR (4) JKOR  
 (SSC CHSL (10+2) DEO & LDC Exam. 16.11.2014)
- 252. DLOC : ECI :: TOH : ?**  
 (1) EET (2) EAT  
 (3) AET (4) ETA  
 (SSC CHSL (10+2) DEO & LDC Exam. 16.11.2014)

- Directions :** In each of the following questions, select the related letter from the given alternatives.
- 253. AROUND : RAUODN :: GROUND : ?**  
 (1) RGUODN (2) NDOOGR  
 (3) OUNDGR (4) DNUURG  
 (SSC CGL Tier-I Exam. 19.10.2014 TF No. 022 MH 3)
- 254. APPROACHED : ROACHEDAPP :: BARGAINED : ?**  
 (1) AINEDBARG (2) GAINEDBAR  
 (3) GAINEDRAB (4) RABGAINED  
 (SSC CGL Tier-I Exam. 19.10.2014 TF No. 022 MH 3)
- 255. BDG : HJM :: NPS : ?**  
 (1) TVY (2) UVY  
 (3) WXZ (4) TWZ  
 (SSC CHSL (10+2) DEO & LDC Exam. 16.11.2014, Ist Sitting TF No. 333 LO 2)
- 256. ABC : ZYX :: CBA : ?**  
 (1) BCA (2) XZY  
 (3) YZX (4) XYZ  
 (SSC CHSL (10+2) DEO & LDC Exam. 16.11.2014, Ist Sitting TF No. 333 LO 2)
- 257. AEI : OUA :: IEA : ?**  
 (1) AOU (2) AUO  
 (3) EOU (4) EUO  
 (SSC CHSL (10+2) DEO & LDC Exam. 16.11.2014, Ist Sitting TF No. 333 LO 2)
- 258. C : I :: D : ?**  
 (1) L (2) M  
 (3) N (4) O  
 (SSC CHSL (10+2) DEO & LDC Exam. 16.11.2014, IInd Sitting TF No. 545 QP 6)
- 259. YAD : NUS :: ? : NOOM**  
 (1) NTHIG (2) HIGIN  
 (3) GHTIN (4) THGIN  
 (SSC CHSL (10+2) DEO & LDC Exam. 16.11.2014, IInd Sitting TF No. 545 QP 6)
- 260. DCBA : WXYZ :: IJKL : ?**  
 (1) ROPO (2) QPON  
 (3) PONM (4) SRQP  
 (SSC CAPFs SI, CISF ASI & Delhi Police SI Exam, 21.06.2015 (Ist Sitting) TF No. 8037731)
- 261. hive % bee % % eyrie % ?**  
 (1) Parrot (2) Pigeon  
 (3) Eagle (4) Sparrow  
 (SSC CAPFs SI, CISF ASI & Delhi Police SI Exam, 21.06.2015 (Ist Sitting) TF No. 8037731)

- 262. DHLPTX : BFJNRV :: CGKOSW : ?**  
 (1) IJKLMN (2) UMQEIA  
 (3) AEIMQU (4) AIOMUQ  
 (SSC CAPFs SI, CISF ASI & Delhi Police SI Exam, 21.06.2015 (Ist Sitting) TF No. 8037731)
- 263. D : B :: I : C :: P : D :: ?**  
 (1) Y : E (2) X : E  
 (3) Y : D (4) Z : E  
 (SSC CAPFs SI, CISF ASI & Delhi Police SI Exam, 21.06.2015 IInd Sitting)
- 264. A : B :: B : D :: C : F :: ?**  
 (1) E : L (2) D : F  
 (3) F : L (4) L : F  
 (SSC CAPFs SI, CISF ASI & DP SI Exam, 21.06.2015 IInd Sitting)
- 265. AEFJ : KOPT :: ? : QUVZ**  
 (1) HKQL (2) GLKP  
 (3) GKLP (4) HLKP  
 (SSC CGL Tier-I Exam, 09.08.2015 (Ist Sitting) TF No. 1443088)
- 266. MAN : PDQ :: WAN : ?**  
 (1) YDQ (2) ZDQ  
 (3) NAW (4) YQD  
 (SSC CGL Tier-I Exam, 09.08.2015 (Ist Sitting) TF No. 1443088)
- 267.  $\sqrt{AFI} = M$  :  $\sqrt{ADD} = L$  ::  $\sqrt{ABA} = ?$**   
 (1) I (2) N  
 (3) O (4) K  
 (SSC CGL Tier-I Exam, 09.08.2015 (IInd Sitting) TF No. 4239378)
- 268. MIKE : OGMK :: CIAD : ?**  
 (1) EGCB (2) EICB  
 (3) AJCF (4) ENCF  
 (SSC CGL Tier-I Exam, 09.08.2015 (IInd Sitting) TF No. 4239378)
- 269. FIG : EGHJFH :: BIN : ?**  
 (1) ACJHMO (2) CAHJMOC  
 (3) CAJHOM (4) ACHJMO  
 (SSC CGL Tier-I Exam, 16.08.2015 (Ist Sitting) TF No. 3196279)
- 270. D B U : E E Z :: C J H : ?**  
 (1) D N N (2) D M N  
 (3) D M M (4) D N M  
 (SSC CGL Tier-I Exam, 16.08.2015 (Ist Sitting) TF No. 3196279)
- 271. BLOCKED : YOLXPVW :: ? : OZFMMXS**  
 (1) RESULTS (2) DEBATES  
 (3) LAUNNCH (4) LABOURS  
 (SSC CGL Tier-I Exam, 16.08.2015 (Ist Sitting) TF No. 3196279)

**ANALOGY OR SIMILARITY**

- 272.** DFHJ : WUSQ :: HJLN : ?  
 (1) PRTW (2) RTVX  
 (3) SQOM (4) TWYZ  
 (SSC CGL Tier-I Exam, 16.08.2015 (IInd Sitting) TF No. 2176783)
- 273.** JOKE : GLHB :: RISK : ?  
 (1) OFPH (2) SJTL  
 (3) ULVN (4) QHRJ  
 (SSC CGL Tier-I Exam, 16.08.2015 (IInd Sitting) TF No. 2176783)
- 274.** ODXM : SFYN :: UIOZ : ?  
 (1) PAQM (2) LPWA  
 (3) QNLA (4) WKPA  
 (SSC CGL Tier-I Re-Exam, 30.08.2015)
- 275.** BAD : DDH :: CUT : ?  
 (1) DCV (2) DDX  
 (3) ECW (4) EXX  
 (SSC CGL Tier-I Re-Exam, 30.08.2015)
- 276.** DIMO : DMIO :: JUVR : ?  
 (1) JRVU (2) JVRU  
 (3) JVUR (4) JUVR  
 (SSC Constable (GD) Exam, 04.10.2015, Ist Sitting)
- 277.** AK : FP :: XD : ?  
 (1) SJ (2) CI  
 (3) BH (4) TE  
 (SSC Constable (GD) Exam, 04.10.2015, IInd Sitting)
- 278.** HIJK : GFED :: NOPO : ?  
 (1) EFGH (2) BCDE  
 (3) FDEC (4) MLKJ  
 (SSC (10+2) LDC/DEO/PA/SA Exam, 01.11.2015 TF No. 1098066)
- 279.** CEIM : DGLQ :: FGIO : ?  
 (1) GMSI (2) GMIS  
 (3) GILS (4) GLIS  
 (SSC (10+2) LDC/DEO/PA/SA Exam, 01.11.2015 TF No. 1098066)
- 280.** GFEH : ROPS :: LKJM : ?  
 (1) ONMP (2) VUWX  
 (3) LKNM (4) IHJG  
 (SSC (10+2) LDC/DEO/PA/SA Exam, 01.11.2015 TF No. 1098066)
- 281.** 4 : 36 :: ? : 49  
 (1) 6 (2) 8  
 (3) 7 (4) 5  
 (SSC (10+2) LDC/DEO/PA/SA Exam, 01.11.2015 TF No. 1098066)
- 282.** FE : HG :: ML : ?  
 (1) ON (2) PO  
 (3) QP (4) JI  
 (SSC CHSL (10+2) LDC, DEO & PA/SA Exam, 01.11.2015, IInd Sitting)
- 283.** SNAKE : VODNH :: CRADLE : ?  
 (1) FUDGOH (2) FVDGPH  
 (3) EUDGOH (4) EVFGOF  
 (SSC CHSL (10+2) LDC, DEO & PA/SA Exam, 01.11.2015, IInd Sitting)
- 284.** JKPO : LMNM :: ? : PQJI.  
 (1) KOLN (2) LKNO  
 (3) NOLK (4) NOKL  
 (SSC CHSL (10+2) LDC, DEO & PA/SA Exam, 15.11.2015 (Ist Sitting) TF No. 6636838)
- 285.** QPOR : XWVY :: LKJM : ?  
 (1) SRTU (2) DEGF  
 (3) CBAD (4) FHGI  
 (SSC CHSL (10+2) LDC, DEO & PA/SA Exam, 15.11.2015 (Ist Sitting) TF No. 6636838)
- 286.** VVXY : RRTU :: FFHI : ?  
 (1) XXYB (2) CCDF  
 (3) UUVZ (4) SSUV  
 (SSC CHSL (10+2) LDC, DEO & PA/SA Exam, 15.11.2015 (Ist Sitting) TF No. 6636838)
- 287.** SUMO : PRJL :: TAXI : ?  
 (1) ODNF (2) WDXJ  
 (3) QDVF (4) QXUF  
 (SSC CHSL (10+2) LDC, DEO & PA/SA Exam, 15.11.2015 (IInd Sitting) TF No. 7203752)
- 288.** PS : VY :: FI : ?  
 (1) UX (2) VZ  
 (3) WZ (4) LO  
 (SSC CHSL (10+2) LDC, DEO & PA/SA Exam, 15.11.2015 (IInd Sitting) TF No. 7203752)
- 289.** KcaC : CacK :: XgmF : ?  
 (1) EgmX (2) FmgX  
 (3) Gmef (4) EmgF  
 (SSC CHSL (10+2) LDC, DEO & PA/SA Exam, 15.11.2015 (IInd Sitting) TF No. 7203752)
- 290.** RORRIM : MIRROR :: TNESERP : ?  
 (1) TNERESP (2) PRESENT  
 (3) CRESENT (4) STNERPE  
 (SSC CHSL (10+2) LDC, DEO & PA/SA Exam, 06.12.2015 (Ist Sitting) TF No. 1375232)
- 291.** EAC : KGI :: HDF : ?  
 (1) PLN (2) KIJ  
 (3) FBD (4) NJL  
 (SSC CHSL (10+2) LDC, DEO & PA/SA Exam, 06.12.2015 (Ist Sitting) TF No. 1375232)
- 292.** BUT : TUB :: NET : ?  
 (1) TEN (2) PET  
 (3) LET (4) TWO  
 (SSC CHSL (10+2) LDC, DEO & PA/SA Exam, 06.12.2015 (Ist Sitting) TF No. 1375232)
- 293.** ABDE : GHJK :: MNPO : ?  
 (1) RSUV (2) CEFH  
 (3) STVX (4) RTUW  
 (SSC CHSL (10+2) LDC, DEO & PA/SA Exam, 06.12.2015 (IInd Sitting) TF No. 3441135)
- 294.** ACE : GIK :: MOQ : ?  
 (1) SUW (2) STU  
 (3) RTU (4) VXZ  
 (SSC CHSL (10+2) LDC, DEO & PA/SA Exam, 06.12.2015 (IInd Sitting) TF No. 3441135)
- 295.** GNIDAEER : READING :: NOITU-LOS : ?  
 (1) SOLUTION (2) SOLUNOIT  
 (3) NOILOSUT (4) POLLUTION  
 (SSC CHSL (10+2) LDC, DEO & PA/SA Exam, 06.12.2015 (IInd Sitting) TF No. 3441135)
- 296.** CAT : DDY :: BIG : ?  
 (1) CLM (2) CML  
 (3) CEP (4) CLL  
 (SSC CHSL (10+2) LDC, DEO & PA/SA Exam, 20.12.2015 (Ist Sitting) TF No. 9692918)
- 297.** EAGLE : FCJJPJ :: CRAWL : ?  
 (1) DTDBRC (2) DTFRCR  
 (3) DTDAQ (4) DTEZQ  
 (SSC CHSL (10+2) LDC, DEO & PA/SA Exam, 20.12.2015 (Ist Sitting) TF No. 9692918)
- 298.** CEGI : DHLP :: KSEA : ?  
 (1) LVJH (2) LSGF  
 (3) LTGI (4) LUIH  
 (SSC CHSL (10+2) LDC, DEO & PA/SA Exam, 20.12.2015 (Ist Sitting) TF No. 9692918)
- 299.** GHJM : QRTW :: CDFI : ?  
 (1) NOPR (2) MNPS  
 (3) XYZQ (4) GHIJ  
 (SSC (10+2) Stenographer Grade 'C' & 'D' Exam, 31.01.2016 TF No. 3513283)
- 300.** CIQY : DJRZ :: AGOW : ?  
 (1) BJPX (2) BHPX  
 (3) BHPU (4) BJRZ  
 (SSC (10+2) Stenographer Grade 'C' & 'D' Exam, 31.01.2016 TF No. 3513283)
- 301.** CAFD : IGLJ :: OMRP : ?  
 (1) ZYXW (2) USXV  
 (3) UTSR (4) PONM  
 (SSC (10+2) Stenographer Grade 'C' & 'D' Exam, 31.01.2016 TF No. 3513283)

**ANALOGY OR SIMILARITY**

**Directions (302-304) :** In each of the following questions, select the related letters from the given alternatives.  
(SSC (10+2) Stenographer Grade 'C' & 'D'  
Exam. 31.07.2016)

- 302.** MAD : JXA :: RUN : ?  
(1) PRJ (2) UXQ  
(3) ORK (4) OSQ
- 303.** BEGK : ADFJ :: PSVY : ?  
(1) ROUX (2) LQUT  
(3) LOQT (4) ORUX
- 304.** AZBY : CXDW :: EVFU : ?  
(1) TGSH (2) GTHS  
(3) GSTH (4) GHTS
- 305.** Select the related letters from the given alternatives:  
RIGT : WDBY :: FUSH : ?  
(1) PKJQ (2) BYWD  
(3) DXWB (4) QKJR  
(SSC CGL Tier-I (CBE) Exam.10.09.2016)
- 306.** Select the related letters from the given alternatives:  
DCBA : WXYZ :: IJKL : ?  
(1) SRQP (2) QPON  
(3) RQPO (4) PONM  
(SSC CGL Tier-I (CBE) Exam.11.09.2016) (1st Sitting)
- 307.** Select the related letters/words from the given alternatives.  
JAUNDICE : AJNUIDEC :: MET-APHOR : ?  
(1) EMATHPRO (2) EMAPROTH  
(3) ETHPMARO (4) EAMTHPRO  
(SSC CPO SI, ASI Online Exam.05.06.2016) (1Ind Sitting)
- 308.** Select the related letters from the given alternatives.  
ACFJ : QUXZ :: DFIM : ?  
(1) MRUW (2) NRUW  
(3) WURN (4) BURN  
(SSC CPO Exam. 06.06.2016) (1st Sitting)
- 309.** Select the related letters from the given alternatives:  
BDGK : ACFJ :: ? : DFIM  
(1) FKGH (2) EGJN  
(3) EGIK (4) FGHI  
(SSC CHSL (10+2) Tier-I (CBE) Exam. 08.09.2016) (1st Sitting)
- 310.** Select the related letters from the given alternatives:  
ACEG : IKMO :: QSUW : ?  
(1) YZCE (2) YACD  
(3) YACE (4) YBCE  
(SSC CGL Tier-I (CBE) Exam. 09.09.2016) (1st Sitting)

**Directions (311-312) :** In each of the following questions, select the related word/letters/number from the given alternatives.

- (SSC CAPFs (CPO) SI & ASI, Delhi Police Exam. 20.03.2016) (1Ind Sitting)
- 311.** R : ARE :: U : ?  
(1) URE (2) VEE  
(3) IUE (4) YOU
- 312.** UASC : YEWG :: DHLO : ?  
(1) LHUS (2) HSPL  
(3) HLPS (4) HLOD
- 313.** Select the related letters from the given alternatives.  
LMK : STR :: IJH : ?  
(1) QSR (2) SUT  
(3) ZAY (4) ADC  
(SSC CAPFs (CPO) SI & ASI, Delhi Police Exam. 05.06.2016) (1st Sitting)
- 314.** Select the related letters from the given alternatives.  
PRT : QSU :: VXZ : ?  
(1) WYB (2) WYA  
(3) ACE (4) VYB  
(SSC CAPFs (CPO) SI & ASI, Delhi Police Exam. 05.06.2016) (1st Sitting)
- 315.** Select the related letters from the given alternatives.  
YAC : CEG :: NOQ : ?  
(1) RSU (2) RUS  
(3) STV (4) SVT  
(SSC CAPFs (CPO) SI & ASI, Delhi Police Exam. 05.06.2016) (1st Sitting)
- 316.** Select the related letters from the given alternatives.  
HAPPY : ibqqz :: FRESH : ?  
(1) gsfti (2) gsdti  
(3) gsftj (4) esftg  
(SSC CPO SI & ASI, Online Exam. 06.06.2016) (1Ind Sitting)
- 317.** Select the related letters from the given alternatives.  
GAYATRI : AAR :: PALLAVI : ?  
(1) ALI (2) AAL  
(3) ALA (4) ALV  
(SSC CPO SI & ASI, Online Exam. 06.06.2016) (1Ind Sitting)
- 318.** Select the related letters from the given alternatives :  
DHL : PTX :: BFJ : ?  
(1) NRV (2) RVZ  
(3) CGK (4) KOS  
(SSC CGL Tier-I (CBE) Exam. 27.08.2016) (1st Sitting)

**319.** Select the related letters from the given alternatives :

- DHL : PTX :: BFJ : ?  
(1) KOS (2) NRV  
(3) NRU (4) NPS  
(SSC CGL Tier-I (CBE) Exam. 27.08.2016) (1Ind Sitting)
- 320.** Select the related letters from the given alternatives.  
ABDE : FGIJ :: IJLM : ?  
(1) NMOP (2) NOPQ  
(3) NOQR (4) NPQR  
(SSC CGL Tier-I (CBE) Exam. 27.08.2016) (1Ind Sitting)
- 321.** Select the related letters from the given alternatives.  
PZQW : NXOU :: FISK : ?  
(1) EFPJ (2) FERI  
(3) DGQI (4) HKVM  
(SSC CGL Tier-I (CBE) Exam. 28.08.2016) (1Ind Sitting)
- 322.** Select the related letters from the given alternatives.  
BDFH : YWUS :: JLNP : ?  
(1) QOMK (2) ACEF  
(3) ZXUT (4) UVWX  
(SSC CGL Tier-I (CBE) Exam. 29.08.2016) (1Ind Sitting)
- 323.** Select the related letters from the given alternatives :  
AEIM : BFJN :: CGKO : ?  
(1) DHLI (2) ZVRP  
(3) BCDK (4) MPQR  
(SSC CGL Tier-I (CBE) Exam. 30.08.2016) (1st Sitting)
- 324.** Select the related letters from the given alternatives:  
DBCE : QOPR :: JLKI : ?  
(1) YWXU (2) WYXV  
(3) WXYV (4) WYVX  
(SSC CGL Tier-I (CBE) Exam. 31.08.2016) (1st Sitting)
- 325.** Select the related letters from the given alternatives.  
EGIK : FHJL :: MOQS : ?  
(1) LNOQ (2) NPRT  
(3) KMOQ (4) NRPT  
(SSC CGL Tier-I (CBE) Exam. 01.09.2016) (1st Sitting)
- 326.** Select the related letters from the given alternatives.  
AKU : ? :: CMW : DNX  
(1) BGL (2) BLO  
(3) BGQ (4) BLV  
(SSC CGL Tier-I (CBE) Exam. 02.09.2016) (1st Sitting)

**ANALOGY OR SIMILARITY**

**327.** Select the related letters from the given alternatives.

TSR : FED :: WVU : ?

- (1) CAB (2) MLK  
(3) PQS (4) GFH

(SSC CGL Tier-I (CBE)

Exam. 02.09.2016) (IInd Sitting)

**328.** Select the related letters from the given alternatives.

DHLP : WSOK :: FJNR : ?

- (1) UQMI (2) TPLH  
(3) SOKG (4) VRNJ

(SSC CGL Tier-I (CBE)

Exam. 03.09.2016) (IInd Sitting)

**329.** Select the related letters from the given alternatives :

EGIK : FILO :: FHJL : ?

- (1) JGMP (2) JGPM  
(3) GJMP (4) GMJP

(SSC CGL Tier-I (CBE)

Exam. 04.09.2016) (1st Sitting)

**330.** Select the related letters from the given alternatives:

DCEF : QPRS :: XWYZ : ?

- (1) SRQP (2) NMOP  
(3) STOV (4) IMGF

(SSC CGL Tier-I (CBE)

Exam. 06.09.2016) (1st Sitting)

**331.** Select the related letters from the given alternatives :

LNPR : TVXZ :: ? : NPRT

- (1) FHJL (2) FLJH  
(3) HFLJ (4) JLHF

(SSC CGL Tier-I (CBE)

Exam. 07.09.2016) (1st Sitting)

**332.** Select the related letters from the given alternatives.

EJOT : 2 :: YDIN : VAFK

- (1) LQGB (2) BGLQ  
(3) QBGL (4) BGQL

(SSC CGL Tier-I (CBE)

Exam. 30.08.2016) (IInd Sitting)

**333.** Select the related letters from the given alternatives :

GrTK : KtrG :: FjbH : ?

- (1) HbjF (2) jHbF  
(3) FbjH (4) Hjbf

(SSC CGL Tier-I (CBE)

Exam. 31.08.2016) (IInd Sitting)

**334.** Select the related letters from the given alternatives.

GDM : ROX :: AOP : ?

- (1) MZA (2) LAB  
(3) LZA (4) MBA

(SSC CPO SI, ASI Online

Exam.05.06.2016) (IInd Sitting)

**335.** Select the related letters from the given alternatives :

ABDG : CDFI :: EFHK : ?

- (1) GHJM (2) HILN  
(3) HIMN (4) HIKM

(SSC CGL Tier-I (CBE)

Exam. 01.09.2016) (1st Sitting)

**336.** Select the related letters from the given alternatives :

BDCE : FHGI :: RTSU : ?

- (1) VYWX (2) XYVW  
(3) VWXY (4) VXWY

(SSC CGL Tier-I (CBE)

Exam. 02.09.2016) (1st Sitting)

**337.** Select the related letters from the given alternatives :

ACXZ : BDWY :: CEVX : ?

- (1) DFUZ (2) DFUW  
(3) DGUW (4) DFUV

(SSC CGL Tier-I (CBE)

Exam. 28.08.2016) (1st Sitting)

**338.** Select the related letters from the given alternatives :

ACEG : ZXVT :: IKMO : ?

- (1) MNOP (2) PQRS  
(3) RPNL (4) LNPR

(SSC CGL Tier-I (CBE)

Exam. 29.08.2016) (1st Sitting)

**339.** Select the related letters from the given alternatives :

ADFG : KNPQ :: DGIJ : ?

- (1) NORS (2) NPQS  
(3) NOST (4) NQTU

(SSC CGL Tier-I (CBE)

Exam. 30.08.2016) (IInd Sitting)

**340.** Select the related letters from the given alternatives :

MOLTU : ? :: HOPE : IPQF

- (1) MPNUV (2) NPMUV  
(3) NPMVU (4) MPNVU

(SSC CGL Tier-I (CBE)

Exam. 31.08.2016) (IInd Sitting)

**341.** Select the related letters from the given alternatives :

LNPO : ACEF :: TVXY : ?

- (1) IMKL (2) IKMO  
(3) IKMN (4) PKLR

(SSC CGL Tier-I (CBE)

Exam. 01.09.2016) (IInd Sitting)

**342.** Select the related letters from the given alternatives :

BDCE : GIHJ :: QSRT : ?

- (1) VWXY (2) UWMX  
(3) VXWY (4) UWNX

(SSC CGL Tier-I (CBE)

Exam. 02.09.2016) (IInd Sitting)

**343.** Select the related letters from the given alternatives :

JMPS : ADGJ :: QTWZ : ?

- (1) OLRU (2) LORU  
(3) LOSU (4) LPRU

(SSC CGL Tier-I (CBE)

Exam. 03.09.2016) (IIIrd Sitting)

**344.** Select the related letters from the given alternatives :

FED : IHG :: ? : ?

- (1) ACB : GUV  
(2) TSR : WVU  
(3) VUK : LMO  
(4) DEF : IGH

(SSC CGL Tier-I (CBE)

Exam. 04.09.2016) (IIIrd Sitting)

**345.** Select the related letters from the given alternatives :

EFG : VUT :: KLM : ?

- (1) KJH (2) PON  
(3) ZXY (4) FDC

(SSC CGL Tier-I (CBE)

Exam. 06.09.2016) (IIIrd Sitting)

**346.** Select the related letters from the given alternatives :

BEF : GJK :: LOP : ?

- (1) QUV (2) QTU  
(3) QST (4) QUT

(SSC CGL Tier-I (CBE)

Exam. 07.09.2016) (IIIrd Sitting)

**347.** Select the related letters from the given alternatives :

ACEG : BDFH :: IKMO : ?

- (1) IJKL (2) JLNP  
(3) KLMN (4) HIJK

(SSC CGL Tier-I (CBE)

Exam. 08.09.2016) (IIIrd Sitting)

**348.** Select the related letters from the given alternatives :

QSUW : TVXZ :: ACEG : ?

- (1) KMNP (2) EGMN  
(3) DFHJ (4) FHIL

(SSC CGL Tier-I (CBE)

Exam. 09.09.2016) (IInd Sitting)

**349.** Select the related letters from the given alternatives :

FJSP : DLQR :: GMIL : ?

- (1) EOGN (2) JNIO  
(3) HOGN (4) IONG

(SSC CGL Tier-I (CBE)

Exam. 10.09.2016) (IIIrd Sitting)

**350.** Select the related letters from the given alternatives :

ECFG : FDGH :: SQTU : ?

- (1) TRVU (2) TVUR  
(3) TRUV (4) SRTV

(SSC CGL Tier-I (CBE)

Exam. 03.09.2016) (IInd Sitting)

**ANALOGY OR SIMILARITY**

**351.** Select the related letters from the given alternatives :

BFJ : NRV :: DHL : ?

- (1) PTA (2) PTX  
(3) KQS (4) MQV

(SSC CGL Tier-I (CBE)

Exam. 04.09.2016) (IInd Sitting)

**352.** Select the related letters from the given alternatives :

ACEG : BDFH :: PRTV : ?

- (1) QSUW (2) WUSQ  
(3) QOSU (4) CEGI

(SSC CGL Tier-I (CBE)

Exam. 06.09.2016) (IInd Sitting)

**353.** Select the related letters from the given alternatives :

ZXVT : ACEG :: SQOM : ?

- (1) FHJL (2) HJLN  
(3) JLMO (4) IKMO

(SSC CGL Tier-I (CBE)

Exam. 07.09.2016) (IInd Sitting)

**354.** Select the related letters from the given alternatives :

OOQR : QQST :: UUWX : ?

- (1) WWYZ (2) YYWZ  
(3) ZZWY (4) YYZZ

(SSC CGL Tier-I (CBE)

Exam. 08.09.2016) (IInd Sitting)

**355.** Select the related letters from the given alternatives :

ZXVT : YWUS :: RPNL : ?

- (1) XVTS (2) TSQP  
(3) SQPM (4) QOMK

(SSC CGL Tier-I (CBE)

Exam. 09.09.2016) (IInd Sitting)

**356.** Select the related letters from the given alternatives :

BECD : GJHI :: LOMN : ?

- (1) PSRQ (2) PQRS  
(3) QTSR (4) QTRS

(SSC CGL Tier-I (CBE)

Exam. 10.09.2016) (IInd Sitting)

**357.** Select the related letters from the given alternatives :

LAMP : IXJM :: FISH : ?

- (1) CGPF (2) CFQE  
(3) CFPE (4) CGQF

(SSC CGL Tier-I (CBE)

Exam. 11.09.2016) (Ist Sitting)

**358.** Select the related letters from the given alternatives.

JK : QR :: \_\_\_\_ ? : \_\_\_\_ ?

- (1) ST : UV (2) WX : ZY  
(3) BC : IJ (4) MN : OR

(SSC CGL Tier-I (CBE)

Exam. 11.09.2016) (IInd Sitting)

**359.** Select the related letters from the given alternatives.

ABDF : GHJL :: MNPR : ?

- (1) STVX (2) TVXZ  
(3) UWXZ (4) TSXZ

(SSC CGL Tier-I (CBE)

Exam. 27.10.2016) (Ist Sitting)

**360.** Select the related letters from the given alternatives.

BFG : EIJ :: RVW : ?

- (1) UWY (2) UYZ  
(3) SWX (4) QUV

(SSC CGL Tier-I (CBE)

Exam. 27.10.2016) (IInd Sitting)

**361.** Select the related letters from the given alternatives :

GLIDERS : ERSDGLI :: TOAST-ER : ?

- (1) TERSTAO (2) TESRTOA  
(3) TERSTOA (4) TERRTOA

(SSC CHSL (10+2) Tier-I (CBE)

Exam. 15.01.2017) (IInd Sitting)

**362.** Select the related letters from the given alternatives :

OFFICIAL : QHHKEKCN :: LAN-GUAGE : ?

- (1) NCPWICIG (2) NCPIWCIG  
(3) NCPIWICG (4) NCPIWCGI

(SSC CHSL (10+2) Tier-I (CBE)

Exam. 16.01.2017) (IInd Sitting)

**363.** Select the related letters from the given alternatives :

SPINSTER : ROHMRSDQ :: SE-MESTER : ?

- (1) RDDLRSDQ  
(2) RDLDSRDQ  
(3) RDLDRSDQ  
(4) RDLDRDSQ

(SSC CHSL (10+2) Tier-I (CBE)

Exam. 16.01.2017) (IInd Sitting)

**364.** Select the related letters from the given alternatives :

STAR : TSRA :: ROSE : ?

- (1) ORSE (2) ORES  
(3) ESOR (4) SORE

(SSC Multi-Tasking Staff

Exam. 30.04.2017 Ist Sitting)

**TYPE-V**

**Directions :** Select the related letter/number from the given alternatives.

1. DE : 45 :: BC : ?

- (1) 34 (2) 23  
(3) 56 (4) 43

(SSC Combined Matric Level (Pre)

Exam.16.06.2002 (Re-Exam)

2. C : 16 :: F : ?

- (1) 30 (2) 49  
(3) 40 (4) 50

(SSC Combined Graduate Level Prelim Exam. 11.05.2003 (Ist Sitting)

3. DE : 10 :: HI : ?

- (1) 17 (2) 20  
(3) 36 (4) 46

(SSC Combined Graduate Level Prelim Exam.11.05.2003 (IInd Sitting)

4. CE : 70 :: DE : ?

- (1) 90 (2) 60  
(3) 120 (4) 210

(SSC Combined Graduate Level Prelim Exam. 08.02.2004 (Ist Sitting)

5. M O : 13 11 :: H J : ?

- (1) 19 17 (2) 18 16  
(3) 8 10 (4) 16 18

(SSC Combined Graduate Level Prelim Exam. 08.02.2004 (IInd Sitting)

6. M × N : 13 × 14 :: F × R : ?

- (1) 14 × 15 (2) 5 × 17  
(3) 6 × 18 (4) 7 × 19

(SSC Combined Graduate Level Prelim Exam. 13.11.2005 (Ist Sitting)

7.  $\frac{T}{J} : 2 :: \frac{X}{H} : ?$

- (1) 2 (2) 3

- (3)  $\frac{23}{7}$  (4) 4

(SSC Combined Graduate Level Prelim Exam.13.11.2005 (IInd Sitting)

8. 987 : IHG :: 654 : ?

- (1) FDE (2) FED  
(3) EFD (4) DEF

(SSC Combined Graduate Level Tier-1 Exam.16.05.2010)

9. BORE : 10 :: HOTEL : ?

- (1) 12 (2) 15  
(3) 18 (4) 30

(SSC SAS Exam. 26.06.2010 (Paper-I) (IInd Sitting)

10. IC % 6 % DP : ?

- (1) 14 (2) 10  
(3) 12 (4) 16

(SSC Combined Graduate Level Tier-I Exam. 26.06.2011(IInd Sitting)

11. N × M : 14 × 13 :: X × Z : ?

- (1) 24 × 23 (2) 23 × 24  
(3) 24 × 26 (4) 26 × 23

(SSC CPO (SI, ASIn& Intelligence Officer) Exam. 28.08.2011 (Paper-I)

12. CD : 34 :: AB : ?

- (1) 25 (2) 68  
(3) 12 (4) 21

(SSC Combined Matric Level (PRE) Exam. 21.05.2000 (Ist Sitting (East Zone)

**ANALOGY OR SIMILARITY**

13. B : 16 :: D : ?

- (1) 120 (2) 150  
(3) 256 (4) 200

(SSC Combined Matric Level (PRE)  
Exam. 21.05.2000 (IInd Sitting)  
(Middle Zone, Allahabad)

14. K/T : 11/20 :: J/R : ?

- (1) 10/18 (2) 11/19  
(3) 10/8 (4) 9/10

(SSC Combined Matric Level (PRE)  
Exam. 05.05.2002 (Ist Sitting)  
(Eastern Zone, Guwahati)

15.  $\frac{K}{T} : \frac{20}{11} :: \frac{G}{L} : ?$

- (1)  $\frac{7}{11}$  (2)  $\frac{11}{7}$   
(3)  $\frac{8}{13}$  (4)  $\frac{12}{7}$

(SSC Combined Matric Level (PRE)  
Exam. 05.05.2002 (IInd Sitting)  
(Eastern Zone, Guwahati)

16.  $\frac{C}{L} : \frac{24}{27} :: \frac{E}{N} : ?$

- (1)  $\frac{54}{50}$  (2)  $\frac{56}{45}$   
(3)  $\frac{125}{197}$  (4)  $\frac{56}{54}$

(SSC Combined Matric Level (PRE)  
Exam.05.05.2002 (Ist Sitting)  
(North Zone, Delhi)

17.  $\frac{Z}{26} : \frac{Y}{25} :: \frac{B}{2} : ?$

- (1)  $\frac{S}{19}$  (2)  $\frac{T}{20}$   
(3)  $\frac{A}{1}$  (4)  $\frac{P}{20}$

(SSC Combined Matric Level (Pre) Exam.  
05.05.2002 (IInd Sitting)  
(North Zone Delhi)

18.  $\frac{L}{S} : \frac{12}{19} :: \frac{I}{T} : ?$

- (1)  $\frac{12}{20}$  (2)  $\frac{20}{9}$   
(3)  $\frac{9}{20}$  (4)  $\frac{19}{20}$

(SSC Combined Matric Level (Pre)  
Exam. 12.05.2002 (Ist Sitting)

19. MK :  $\frac{169}{121} :: JH : ?$

- (1)  $\frac{81}{100}$  (2)  $\frac{64}{120}$

(3)  $\frac{100}{81}$  (4)  $\frac{100}{64}$

(SSC Combined Matric Level (Pre) Exam.  
12.05.2002 (IInd Sitting)

20.  $\frac{C}{L} : \frac{24}{27} :: \frac{E}{N} : ?$

- (1)  $\frac{54}{50}$  (2)  $\frac{56}{45}$   
(3)  $\frac{125}{197}$  (4)  $\frac{56}{54}$

(SSC Stenographer Grade 'C' & 'D'  
Exam. 09.01.2011)

21. C 3 F 6 : I9L12 :: K 11 N 14 : ?

- (1) O 15 R 18 (2) R 18 U 21  
(3) Q 17 T 20 (4) L 12 O 15

(SSC Stenographer Grade 'C' & 'D'  
Exam. 09.01.2011)

22. F : 216 :: L : ?

- (1) 1723 (2) 1728  
(3) 1700 (4) 1600

(SSC Graduate Level Tier-I  
Exam. 19.05.2013, Ist Sitting)

23. RUST : 9687 :: TSUR : ?

- (1) 7896 (2) 7869  
(3) 7689 (4) 6789

(SSC CHSL (10+2) DEO & LDC  
Exam. 02.11.2014, IInd Sitting)

24. CAT : 3120 :: MAT : ?

- (1) 1312 (2) 10120  
(3) 13120 (4) 12120

(SSC CHSL (10+2) DEO & LDC  
Exam. 16.11.2014, Patna Region :  
Ist Sitting)

25. Which of the following sets contains correctly matched pairs ?

- (1) (Pulitzer, Cinema), (Templeton, Journalism), (Phalke, Religion), (Kalinga, Science)  
(2) (Pulitzer, Journalism), (Templeton, Religion), (Phalke, Science), (Kalinga, Cinema)  
(3) (Pulitzer, Journalism), (Templeton, Science), (Phalke, Religion), (Kalinga, Cinema)  
(4) (Pulitzer, Journalism, (Templeton, Religion), (Phalke, Cinema), (Kalinga, Science)

(SSC CHSL (10+2) DEO & LDC  
Exam. 16.11.2014, Ist Sitting  
TF No. 333 LO 2)

**Directions** % In each of the following questions, select the related letter/word/number from the given alternatives.

26. TTT : 777 :: RRR : ?

- (1) 555 (2) 666  
(3) 888 (4) 999

(SSC CHSL (10+2) DEO & LDC  
Exam. 16.11.2014, IInd Sitting  
TF No. 545 QP 6)

27. B : 16 :: D : ?

- (1) 256 (2) 64  
(3) 120 (4) 128

(SSC CAPFs SI, CISF ASI & DP SI  
Exam, 21.06.2015 IInd Sitting)

28. D × H : 4 × 8, as M × Q : ?

- (1) 14 × 18 (2) 12 × 17  
(3) 12 × 16 (4) 13 × 17

(SSC CGL Tier-I Exam, 09.08.2015  
(Ist Sitting) TF No. 1443088)

29. Pride of Lions : : \_\_\_\_\_ of Cats

- (1) Bunch (2) Herd  
(3) School (4) Clowder

(SSC CGL Tier-I Exam, 09.08.2015  
(Ist Sitting) TF No. 1443088)

30. Identify which one of the given alternatives will be another member of the group of that class.

- Lucknow, Patna, Bhopal, Jaipur,?  
(1) Shimla (2) Mysore  
(3) Pune (4) Indore

(SSC CGL Tier-I Exam, 09.08.2015  
(IInd Sitting) TF No. 4239378)

31. Find the number that is common for all of the clues given below :

- (a) Virgo (b) Volleyball  
(c) A highest scoring shot of a particular sport  
(d) Extra sensory perceptions

- (1) 8 (2) 2  
(3) 6 (4) 4

(SSC CGL Tier-I Exam, 16.08.2015  
(Ist Sitting) TF No. 3196279)

32.  $Y^2 : 4 :: V^2 : ?$

- (1) 9 (2) 25  
(3) 49 (4) 16

(SSC CGL Tier-I Exam, 16.08.2015  
(IInd Sitting) TF No. 2176783)

33. If PNLJ : 2468, then QOKL : ?

- (1) 3591 (2) 1367  
(3) 1276 (4) 1376

(SSC (10+2) LDC/DEO/PA/SA  
Exam. 01.11.2015 TF No. 1098066)

34.  $\sqrt{AFI} : 13 :: \sqrt{DDA} : ?$

- (1) 12 (2) 22  
(3) 21 (4) 24

(SSC CHSL (10+2) LDC, DEO & PA/SA  
Exam, 01.11.2015, IInd Sitting)

**ANALOGY OR SIMILARITY**

**ANSWERS**

**TYPE-I**

1. (2)	2. (4)	3. (2)	4. (4)
5. (3)	6. (3)	7. (3)	8. (2)
9. (1)	10. (1)	11. (2)	12. (3)
13. (3)	14. (1)	15. (4)	16. (2)
17. (2)	18. (3)	19. (2)	20. (3)
21. (1)	22. (3)	23. (3)	24. (3)
25. (1)	26. (1)	27. (1)	28. (4)
29. (2)	30. (3)	31. (3)	32. (3)
33. (3)	34. (3)	35. (1)	36. (2)
37. (3)	38. (3)	39. (2)	40. (4)
41. (1)	42. (2)	43. (1)	44. (1)
45. (1)	46. (2)	47. (2)	48. (4)
49. (1)	50. (4)	51. (2)	52. (3)
53. (2)	54. (2)	55. (2)	56. (3)
57. (3)	58. (1)	59. (3)	60. (1)
61. (2)	62. (3)	63. (1)	64. (2)
65. (4)	66. (1)	67. (2)	68. (4)
69. (4)	70. (3)	71. (3)	72. (3)
73. (3)	74. (3)	75. (3)	76. (3)
77. (1)	78. (4)	79. (1)	80. (2)
81. (4)	82. (2)	83. (3)	84. (4)
85. (1)	86. (4)	87. (4)	88. (3)
89. (1)	90. (1)	91. (4)	92. (2)
93. (1)	94. (3)	95. (2)	96. (1)
97. (1)	98. (1)	99. (2)	100. (3)
101. (3)	102. (3)	103. (1)	104. (3)
105. (3)	106. (2)	107. (4)	108. (2)
109. (4)	110. (4)	111. (2)	112. (2)
113. (3)	114. (3)	115. (1)	116. (3)
117. (4)	118. (1)	119. (2)	120. (1)
121. (4)	122. (4)	123. (3)	124. (3)
125. (4)	126. (2)	127. (2)	128. (2)
129. (2)	130. (4)	131. (3)	132. (1)
133. (1)	134. (1)	135. (4)	136. (2)
137. (1)	138. (2)	139. (3)	140. (1)
141. (1)	142. (1)	143. (3)	144. (3)
145. (3)	146. (3)	147. (3)	148. (4)

149. (2)	150. (2)	151. (2)	152. (4)
153. (3)	154. (3)	155. (4)	156. (2)
157. (3)	158. (3)	159. (2)	160. (3)
161. (1)	162. (4)	163. (1)	164. (2)
165. (1)	166. (3)	167. (4)	168. (1)
169. (4)	170. (3)	171. (3)	172. (4)
173. (3)	174. (2)	175. (3)	176. (2)
177. (4)	178. (1)	179. (2)	180. (3)
181. (1)	182. (1)	183. (1)	184. (4)
185. (3)	186. (3)	187. (3)	188. (2)
189. (4)	190. (2)	191. (4)	192. (1)
193. (3)	194. (2)	195. (2)	196. (1)
197. (2)	198. (4)	199. (4)	200. (1)
201. (4)	202. (2)	203. (2)	204. (3)
205. (4)	206. (4)	207. (2)	208. (3)
209. (3)	210. (4)	211. (3)	212. (3)
213. (1)	214. (4)	215. (3)	216. (1)
217. (3)	218. (4)	219. (2)	220. (3)
221. (3)	222. (2)	223. (4)	224. (2)
225. (3)	226. (4)	227. (3)	228. (3)
229. (1)	230. (3)	231. (2)	232. (3)
233. (3)	234. (3)	235. (4)	236. (2)
237. (3)	238. (2)	239. (2)	240. (3)
241. (3)	242. (2)	243. (2)	244. (2)
245. (1)	246. (2)	247. (2)	248. (2)
249. (1)	250. (1)	251. (1)	252. (2)
253. (2)	254. (3)	255. (4)	256. (1)
257. (3)	258. (4)	259. (3)	260. (1)
261. (3)	262. (1)	263. (3)	264. (1)
265. (2)	266. (4)	267. (1)	268. (2)
269. (3)	270. (3)	271. (2)	272. (1)
273. (3)	274. (1)	275. (4)	276. (3)
277. (3)	278. (1)	279. (1)	280. (4)
281. (4)	282. (2)	283. (2)	284. (3)
285. (2)	286. (4)	287. (1)	288. (1)
289. (2)	290. (2)	291. (2)	292. (3)
293. (3)	294. (4)	295. (3)	296. (4)
297. (2)	298. (3)	299. (4)	300. (2)
301. (3)	302. (3)	303. (2)	304. (1)
305. (3)	306. (2)	307. (4)	308. (3)

309. (3)	310. (4)	311. (3)	312. (2)
313. (3)	314. (2)	315. (3)	316. (1)
317. (4)	318. (2)	319. (4)	320. (1)
321. (4)	322. (1)	323. (4)	324. (2)
325. (1)	326. (3)	327. (3)	328. (3)
329. (4)	330. (4)	331. (3)	332. (3)
333. (4)	334. (4)	335. (3)	336. (4)
337. (1)	338. (2)	339. (3)	340. (3)
341. (2)	342. (3)	343. (3)	344. (1)
345. (3)	346. (4)	347. (3)	348. (4)
349. (4)	350. (2)	351. (1)	352. (1)
353. (1)	354. (1)	355. (2)	356. (3)
357. (3)	358. (4)	359. (3)	360. (2)
361. (4)	362. (4)	363. (1)	364. (4)
365. (1)	366. (1)	367. (3)	368. (2)
369. (3)	370. (2)	371. (3)	372. (4)
373. (3)	374. (1)	375. (3)	376. (1)
377. (2)	378. (1)	379. (2)	380. (1)
381. (3)	382. (2)	383. (4)	384. (4)
385. (4)	386. (3)	387. (2)	388. (4)
389. (2)	390. (3)	391. (4)	392. (1)
393. (3)	394. (2)	395. (4)	396. (2)
397. (4)	398. (3)	399. (1)	400. (1)
401. (3)	402. (4)	403. (2)	404. (1)
405. (3)	406. (2)	407. (3)	408. (2)
409. (3)	410. (4)	411. (3)	412. (2)
413. (4)	414. (3)	415. (4)	416. (3)
417. (1)			

**TYPE-II**

1. (3)	2. (3)	3. (4)	4. (1)
5. (2)	6. (2)	7. (3)	8. (2)
9. (3)	10. (1)	11. (1)	12. (3)
13. (2)	14. (4)	15. (2)	16. (2)
17. (1)	18. (1)	19. (3)	20. (3)
21. (1)	22. (2)	23. (2)	24. (4)
25. (4)	26. (4)	27. (3)	28. (2)
29. (3)	30. (2)	31. (4)	32. (3)
33. (4)	34. (1)	35. (2)	36. (2)
37. (4)	38. (4)	39. (3)	40. (4)

**ANALOGY OR SIMILARITY**

**TYPE-III**

1. (3)	2. (4)	3. (3)	4. (4)
5. (1)	6. (2)	7. (3)	8. (2)
9. (2)	10. (2)	11. (1)	12. (2)
13. (4)	14. (3)	15. (1)	16. (1)
17. (2)	18. (3)	19. (4)	20. (2)
21. (3)	22. (1)	23. (2)	24. (2)
25. (2)	26. (1)	27. (2)	28. (1)
29. (2)	30. (3)	31. (4)	32. (3)
33. (2)	34. (2)	35. (2)	36. (2)
37. (1)	38. (1)	39. (1)	40. (3)
41. (2)	42. (3)	43. (4)	44. (4)
45. (2)	46. (3)	47. (1)	48. (1)
49. (1)	50. (1)	51. (2)	52. (3)
53. (4)	54. (3)	55. (3)	56. (4)
57. (3)	58. (3)	59. (2)	60. (2)
61. (2)	62. (4)	63. (2)	64. (2)
65. (4)	66. (4)	67. (1)	68. (2)
69. (2)	70. (2)	71. (3)	72. (2)
73. (3)	74. (3)	75. (*)	76. (2)
77. (2)	78. (2)	79. (1)	80. (2)
81. (4)	82. (1)	83. (1)	84. (2)
85. (2)	86. (2)	87. (2)	88. (3)
89. (2)	90. (2)	91. (2)	92. (1)
93. (2)	94. (1)	95. (1)	96. (4)
97. (1)	98. (2)	99. (4)	100. (2)
101. (3)	102. (1)	103. (3)	104. (2)
105. (2)	106. (2)	107. (3)	108. (1)
109. (1)	110. (1)	111. (3)	112. (3)
113. (1)	114. (2)	115. (3)	116. (1)
117. (1)	118. (2)	119. (4)	120. (4)
121. (4)	122. (3)	123. (1)	124. (3)
125. (2)	126. (4)	127. (4)	128. (4)
129. (2)	130. (1)	131. (3)	132. (3)
133. (2)	134. (2)	135. (1)	136. (3)
137. (2)	138. (4)	139. (3)	140. (2)
141. (3)	142. (2)	143. (2)	144. (1)
145. (2)	146. (4)	147. (3)	148. (1)
149. (2)	150. (3)	151. (1)	152. (1)
153. (4)	154. (3)	155. (2)	156. (2)

157. (2)	158. (1)	159. (3)	160. (4)
161. (2)	162. (3)	163. (3)	164. (3)
165. (2)	166. (2)	167. (2)	168. (2)
169. (2)	170. (1)	171. (2)	172. (4)
173. (3)	174. (3)	175. (2)	176. (3)
177. (3)	178. (1)	179. (2)	180. (2)
181. (4)	182. (1)	183. (3)	184. (2)
185. (2)	186. (2)	187. (1)	188. (3)
189. (4)	190. (2)	191. (3)	192. (1)
193. (4)	194. (4)	195. (1)	196. (1)
197. (3)	198. (4)	199. (3)	200. (3)
201. (2)	202. (3)	203. (3)	204. (3)
205. (4)	206. (1)	207. (3)	208. (2)
209. (1)	210. (2)	211. (2)	212. (4)
213. (4)	214. (3)	215. (2)	216. (2)
217. (3)	218. (1)	219. (2)	220. (4)
221. (2)	222. (1)	223. (2)	224. (2)
225. (1)	226. (4)	227. (2)	228. (4)
229. (1)	230. (2)	231. (3)	232. (1)
233. (2)	234. (1)	235. (3)	236. (1)
237. (3)	238. (1)	239. (3)	240. (3)
241. (4)	242. (1)	243. (4)	244. (4)
245. (3)	246. (3)	247. (1)	248. (2)
249. (1)	250. (2)	251. (*)	252. (4)
253. (4)	254. (4)	255. (3)	256. (4)
257. (1)	258. (1)	259. (2)	260. (4)
261. (4)	262. (3)	263. (4)	264. (2)
265. (2)	266. (2)	267. (1)	268. (4)
269. (2)	270. (2)	271. (3)	272. (1)
273. (3)	274. (2)	275. (1)	276. (3)
277. (2)	278. (4)	279. (2)	280. (2)
281. (3)	282. (1)	283. (2)	284. (2)
285. (3)	286. (1)	287. (2)	288. (4)
289. (3)	290. (3)	291. (4)	292. (3)
293. (2)	294. (3)	295. (3)	296. (3)
297. (4)	298. (2)	299. (3)	300. (3)
301. (4)	302. (2)	303. (4)	304. (4)
305. (1)	306. (2)	307. (4)	308. (1)
309. (2)	310. (4)	311. (3)	312. (2)
313. (1)	314. (3)	315. (4)	316. (4)

**TYPE-IV**

1. (1)	2. (1)	3. (1)	4. (4)
5. (3)	6. (1)	7. (4)	8. (1)
9. (3)	10. (4)	11. (1)	12. (1)
13. (4)	14. (4)	15. (3)	16. (3)
17. (1)	18. (4)	19. (4)	20. (3)
21. (1)	22. (2)	23. (4)	24. (3)
25. (4)	26. (2)	27. (2)	28. (3)
29. (1)	30. (3)	31. (3)	32. (3)
33. (3)	34. (4)	35. (1)	36. (1)
37. (1)	38. (4)	39. (1)	40. (4)
41. (3)	42. (1)	43. (4)	44. (4)
45. (4)	46. (2)	47. (1)	48. (2)
49. (1)	50. (2)	51. (1)	52. (4)
53. (2)	54. (1)	55. (1)	56. (3)
57. (1)	58. (4)	59. (3)	60. (2)
61. (1)	62. (2)	63. (2)	64. (3)
65. (3)	66. (1)	67. (4)	68. (3)
69. (3)	70. (3)	71. (3)	72. (3)
73. (4)	74. (2)	75. (4)	76. (4)
77. (1)	78. (3)	79. (4)	80. (4)
81. (2)	82. (1)	83. (2)	84. (1)
85. (1)	86. (3)	87. (1)	88. (4)
89. (4)	90. (2)	91. (1)	92. (3)
93. (3)	94. (3)	95. (4)	96. (4)
97. (2)	98. (2)	99. (1)	100. (4)
101. (1)	102. (4)	103. (4)	104. (2)
105. (3)	106. (4)	107. (1)	108. (4)
109. (3)	110. (4)	111. (2)	112. (1)
113. (1)	114. (4)	115. (1)	116. (2)
117. (4)	118. (3)	119. (2)	120. (2)
121. (2)	122. (4)	123. (2)	124. (3)
125. (1)	126. (2)	127. (3)	128. (2)
129. (3)	130. (1)	131. (4)	132. (3)
133. (3)	134. (4)	135. (3)	136. (4)
137. (1)	138. (2)	139. (3)	140. (4)
141. (1)	142. (4)	143. (3)	144. (3)
145. (1)	146. (2)	147. (2)	148. (2)
149. (2)	150. (3)	151. (4)	152. (1)
153. (4)	154. (1)	155. (1)	156. (2)
157. (2)	158. (1)	159. (1)	160. (1)

## ANALOGY OR SIMILARITY

161. (4)	162. (3)	163. (1)	164. (4)
165. (3)	166. (3)	167. (3)	168. (4)
169. (2)	170. (1)	171. (2)	172. (1)
173. (1)	174. (4)	175. (3)	176. (3)
177. (3)	178. (1)	179. (1)	180. (2)
181. (2)	182. (3)	183. (1)	184. (4)
185. (2)	186. (4)	187. (3)	188. (2)
189. (4)	190. (4)	191. (3)	192. (1)
193. (4)	194. (3)	195. (2)	196. (3)
197. (4)	198. (3)	199. (1)	200. (3)
201. (1)	202. (3)	203. (2)	204. (4)
205. (4)	206. (4)	207. (4)	208. (2)
209. (1)	210. (4)	211. (2)	212. (4)
213. (3)	214. (4)	215. (1)	216. (1)
217. (4)	218. (3)	219. (3)	220. (2)
221. (1)	222. (2)	223. (2)	224. (3)
225. (2)	226. (3)	227. (*)	228. (1)
229. (4)	230. (1)	231. (4)	232. (1)
233. (3)	234. (3)	235. (3)	236. (3)
237. (3)	238. (2)	239. (1)	240. (3)
241. (2)	242. (2)	243. (2)	244. (4)
245. (1)	246. (4)	247. (1)	248. (3)
249. (1)	250. (3)	251. (2)	252. (3)
253. (1)	254. (2)	255. (1)	256. (4)
257. (2)	258. (1)	259. (4)	260. (1)
261. (3)	262. (3)	263. (4)	264. (3)
265. (3)	266. (2)	267. (4)	268. (1)
269. (4)	270. (3)	271. (3)	272. (3)
273. (1)	274. (4)	275. (4)	276. (3)
277. (2)	278. (4)	279. (3)	280. (1)
281. (4)	282. (1)	283. (1)	284. (3)
285. (3)	286. (4)	287. (4)	288. (4)
289. (2)	290. (2)	291. (4)	292. (1)
293. (*)	294. (1)	295. (1)	296. (4)
297. (3)	298. (1)	299. (2)	300. (2)
301. (2)	302. (3)	303. (4)	304. (2)
305. (2)	306. (3)	307. (1)	308. (2)
309. (2)	310. (3)	311. (4)	312. (3)
313. (3)	314. (2)	315. (1)	316. (1)
317. (4)	318. (1)	319. (2)	320. (3)
321. (3)	322. (1)	323. (*)	324. (2)
325. (4)	326. (4)	327. (2)	328. (1)

329. (3)	330. (2)	331. (1)	332. (2)
333. (1)	334. (3)	335. (1)	336. (4)
337. (2)	338. (3)	339. (3)	340. (2)
341. (3)	342. (3)	343. (2)	344. (2)
345. (2)	346. (2)	347. (2)	348. (3)
349. (1)	350. (3)	351. (2)	352. (1)
353. (2)	354. (1)	355. (4)	356. (4)
357. (3)	358. (3)	359. (1)	360. (2)
361. (3)	362. (2)	363. (3)	364. (2)

### TYPE-V

1. (2)	2. (2)	3. (3)	4. (1)
5. (2)	6. (3)	7. (2)	8. (2)
9. (1)	10. (3)	11. (3)	12. (3)
13. (3)	14. (1)	15. (4)	16. (2)
17. (3)	18. (3)	19. (4)	20. (2)
21. (3)	22. (2)	23. (2)	24. (3)
25. (4)	26. (4)	27. (1)	28. (4)
29. (4)	30. (1)	31. (3)	32. (2)
33. (4)	34. (3)		

## EXPLANATIONS

### TYPE-I

1. (2) A Touch has Feeling effect. Similarly, Greet is Acknowledged.
2. (4) Room is a part of the house. Similarly, nation is a part of the world.
3. (2) Diamond is a transparent precious stone of pure carbon. Similarly, corundum is equivalent to Ruby.
4. (4) Smoke leads to pollution. Similarly, War leads to destruction.
5. (3) Pen is filled with ink. Similarly, vein is filled with blood.
6. (3) The second term is antonym of the first term. Hence, Roof : Floor.
7. (3) The habitat (living place) of lion is called Den. Similarly, the living place of rabbit is burrow.
8. (2) Novelty means the quality of being new, different or strange. Oldness shows just the opposite meaning of novelty.  
Antiquity means the ancient past, an object from ancient times.

9. (1) Detective collects vital information with the help of informer. Similarly, Reporter collects news from source.
10. (1) **Genuine** news real, not artificial, sincere, honest etc.  
**Authentic** means known to be true or genuine.  
Thus, Genuine and Authentic are synonymous to each other.  
**Mirage** is an illusion caused by hot air conditions.
11. (2) Thunder is immediately followed by rain. Similarly, dusk is followed by night.
12. (3) Scientific study of plants is called Botany. Similarly, scientific study of insects is called Entomology.
13. (3) The legislative house (Parliament) of Great Britain is called Parliament. Similarly, the Parliament of USA is called Congress.
14. (1) The water in river flows. The water in pool remains stagnant.
15. (4) Psychology is the study of mind, mental condition. Similarly, the scientific study of birds is called ornithology.
16. (2) 'Demand' is of greater intensity than suggestion. Similarly, Snatch is of greater intensity than Take.
17. (2) Maximum and Excess are synonymous to each other. Similarly, Sly and Conservative are synonymous to each other.
18. (3) Mother gives birth to child. Similarly, cloud causes rain.
19. (2) Mountain and hill are similar things. Similarly, tree and shrub are of same type.
20. (3) Book is published by Publisher. Similarly, film is directed by director.
21. (1) The list of food items is called menu. Similarly, the list of books is called catalogue.
22. (3) House rests on framework. Similarly, body is built on skeleton.
23. (3) January is the first month of a year and November is the second last month of a year. Similarly, Sunday is the first day of a week and Friday is the second last day of a week.
24. (3) Tongue is used to taste something. Similarly, leg is used to walk.

## ANALOGY OR SIMILARITY

25. (1) Smoke is emitted through chimney. Similarly, bullet is fired from gun.
26. (1) Camera contains a lens. Similarly flash contains bulb.
27. (1) House is lent on rent. Similarly, capital is lent on interest
28. (4) Architect is responsible for the construction of building. Similarly, statues are carved out by Sculptor.
29. (2) Coldness is the inherent property of ice. Similarly, gravitation is the property of Earth.
30. (3) The lack of blood is called Anaemia. Similarly, the absence of Government is called Anarchy.
31. (3) Editor is responsible for the production of newspaper. Similarly, author writes novel.
32. (3) The smallest form of hour is second. Similarly, primary is the smallest stage.
33. (3) A magnet has two poles, i.e., North and South. Similarly, a battery has two terminals known as positive and negative.
34. (3) **Chaos** is opposite in meaning to **peace**. Similarly, **destruction** is opposite in meaning to **creation**.
35. (1) The pair of synonyms is given.
36. (2) Treatment is done by physician. Judgement is delivered by judge.
37. (3) Stethoscope is an instrument used by doctor. Similarly, Chisel is used by sculptor.
38. (3) Knowledge is acquired through study. Similarly, experience is acquired through work.
39. (2) As Paddy grows in field, so steel is produced in a factory.
40. (4) As there is laughter after a joke, similarly there is explosion after a cracker is burst.
41. (1) As President is the constitutional head of India, similarly the constitutional head of England is king.
42. (2) Light propagates in the form of rays. Similarly, sound travels in the form of waves.
43. (1) If we rotate direction indicator through  $135^\circ$  in clockwise direction the pointer indicating West would show North - East direction.

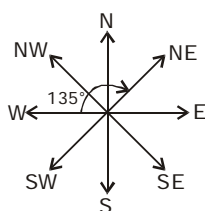

Similarly, if we rotate the direction indicator through  $135^\circ$  in clockwise direction South will become North - West.

44. (1) Oasis is an area with water and trees etc, in desert. Similarly, Island is a piece of land surround by water (sea).
45. (1) Pound and Yen are currencies of different countries. Similarly, Polo and Hockey are names of different games.
46. (2) Quack is the voice of Duck. Similarly, Neigh is the voice of Horse.
47. (2) Dream is antonym of Reality. Similarly, Falsehood is antonym of Truth.
48. (4) A large group of soldiers is called regiment. Similarly, herd refers a group of animals, horses.
49. (1) One who collects stamps is called Philatelist. Similarly, one who collects coins is called Numismatist.
50. (4) Photo is clicked on film. Similarly, photostat is done on paper.
51. (2) Sorrow is antonym of Joy. Similarly, Pleasure is antonym of Pain.
52. (3) Surgeon uses forceps. Similarly, Blacksmith uses hammer.
53. (2) Cloth is woven from thread and mesh is made from wire.
54. (2) A pair of scissors is used to cut cloth. Similarly, axe is used to cut wood.
55. (2) Yesterday  $\rightarrow$  Today  $\rightarrow$  Tomorrow  
March  $\rightarrow$  April  $\rightarrow$  May
56. (3) Bifurcate and Divide imply similar meanings. Similarly, Loathe and Detest imply similar meanings.
57. (3) The flow of river is controlled by constructing dam. Similarly, traffic is controlled by Signal light.
58. (1) The one who studies different varieties of birds is known as Ornithologist. Similarly, Archaeologist studies artifacts.
59. (3) Here animal-behaviour relationship has been shown. Fox is characterised by its cunningness. Similarly, rabbit is considered as timid.
60. (1) Flexible is antonym of Rigid. Similarly, Confidence is antonym of Diffidence.
61. (2) A person cries in the state of sorrow. Similarly, one laughs in the state of mirth.
62. (3) Love is antonym of Hate. Similarly, Proud is antonym of Humble.
63. (1) Light wards off Darkness. Similarly, Knowledge wards off Ignorance.
64. (2) Scissors are used to cut cloth. Similarly, Razor is used to shave.
65. (4) Stethoscope is a scientific instrument which measures heart-beat. Similarly, Thermometer measures temperature.
66. (1) Summer comes after spring. Similarly, Monday comes after Sunday.
67. (2) Ass is considered as Timid. Fox is considered as Cunning.
68. (4) Ecstasy is opposite of Gloom. Similarly, Humiliation is opposite of Exaltation.
69. (4) President is the head of Union Executive of a India. Similarly, Governor is the head of State Executive.
70. (3) Mirage is an illusion caused by hot air conditions making one see something that is not there, especially the appearance of a sheet of water on a hot road or in a desert.  
Rainbow is an arch of seven colours formed in the sky when the sun shines through rain.
71. (3) The body of fish remains covered with scales externally. Similarly, the body of bear remains covered with fur.
72. (3) Here, Worker - Tool relationship has been shown. Writer uses pen for writing. Similarly, painter works on canvas.
73. (3) Procession proceeds on a certain route. Similarly, Earth revolves round the Sun in its orbit.
74. (3) Fertiliser is used for improving crop yield. Similarly, tonic makes body healthy.

---

**ANALOGY OR SIMILARITY**

---

75. (3) The second term is the property of the first term.
76. (3) The second term is analogous to the fourth term. Therefore, the first term would be analogous to the third term.
77. (1) Expression is reflected on the face similarly, Tune is related to the music.
78. (4) The first term is antonymous to the second term.
79. (1) Audio-visual effect is telecast on the television. Similarly, sound wave is broadcast through radio.
80. (2) The first is kept in the second.
81. (4) In this question the first term is related to the third term. Bird and Aeroplane make movement in the air. Similarly, Fish and Ship move in water.
82. (2) The first is the constituent of the second.
83. (3) Spacious means having or providing a lot of space. Spacious denotes capacity  
Scanty means small in size or amount. Thus, Scanty denotes scarcity.
84. (4) First is the instrument used for measuring the second.
85. (1) Lock can be opened with the help of key. Similarly, the cases of crime can be solved investigation.
86. (4) The first is meant for the second.
87. (4) A large number of books are kept in library. Similarly, varieties of animals are kept in zoo.
88. (3) The second term is the opposite of the first term.
89. (1) By breathing we intake air and in the same way blood is circulated.
90. (1) Mathematics is based logic . Similarly, experiment establishes or verifies the theory in science.
91. (4) Editor supervises magazine in the same way as director does in the case of drama and film also.
92. (2) The foot of human being is analogous to the hoof of cow.
93. (1) The ocean contains a large number of drops of water. Similarly, several stars twinkle in the sky.
94. (3) Doctor cures patients in the hospital. Similarly, priest offers prayer and worships god in the temple.
95. (2) Author writes novel and books and designer carves designs or embroidery on dress.
96. (1) Tailor prepares cloth and farmer produces crop.
97. (1) Food is stored in the stomach Similarly, fuel is stored in the engine.
98. (1) Bullet is fired from the gun. Similarly fire emits smoke.
99. (2) The sound made by duck is called quack. Similarly, the roar of bull is called bellow.
100. (3) Elbow is analogous to knee and wrist is analogous to ankle.
101. (3) Scribble is related to writing. Similarly, stammer is related to speak.
102. (3) Mine is possessive case of I. Similarly, his is possessive case of he.
103. (1) Feline is related to the cat family. Similarly, equine is related to horse.
104. (3) Respiratory organ of fish is gills. Similarly, lung is the respiratory organ of man.
105. (3) Brush is used for painting. Similarly, shovel is used for lifting and moving coal.
106. (2) Rough is antonym of smooth. Similarly, systematic is antonym of carefree.
107. (4) Thermometer measures temperature. Barometer measures pressure.
108. (2) Destroy is opposite to create. Similarly, expand is opposite to condense.
109. (4) Audience gathers to see Cinema. Similarly, congregation prays in Church.
110. (4) Reaction is opposite to Action. Similarly, Death is opposite to Birth.
111. (2) The person who eats meat is called carnivorous (Non-Vegetarian). The person who consumes liquor is called Alcoholic and the person who does not consume liquor is called teetotaler.
112. (2) Monday is related to Moon in the same way as Tuesday is related to Mars.
113. (3) The living place of horse is called stable. Similarly, the living place of pig is called sty.
114. (3) Whole is the complete form of Part. Similarly, Circle is the complete form of Arc.
115. (1) The opposite of Immigration is Arrival. Similarly, the opposite of Emigration is Leaving.
116. (3) Blinds possess visual defects. Similarly, a person having auditory defect is called Deaf.
117. (4) The opposite of Monotony is Variety. Similarly, the opposite of Crudeness is Refinement.
118. (1) Raw material of paper is pulp. Similarly, the raw material of rope is hemp.
119. (2) Injury causes pain. Similarly, thunder causes lightning.
120. (1) Critic evaluates book critically. Similarly, appraiser evaluates building.
121. (4) Microphone makes sound louder. Similarly, Microscope helps in viewing micro-organisms by magnifying them.
122. (4) Cup is used to drink something with the help of lips. Similarly, bird collects grasses with the help of beaks to make nest.
123. (3) Glove is wore on hands. Similarly, socks are wore on feet.
124. (3) Umbrella protects us from rain. Similarly, dam checks flood.
125. (4) Receptionist welcomes visitors in an office. Similarly, hostess welcomes passengers in aircraft.
126. (2) Baby grows into adult. Similarly, bud develops into flower.
127. (2) Typist uses Typewriter to write anything. Similarly, writer writes with pen.
128. (2) Carrot is a modified root. Similarly, apple is a fruit.
129. (2) Pigeon symbolises peace. Similarly, White Flag symbolises surrender.
130. (4) Chisel is the tool of Sculptor, Similarly, Pen is the tool of Author.
131. (3) Book is kept in Bookcase. Similarly, Clothes are kept in Wardrobe.
132. (1) Music is systematic arrangement of notation (musical notes). Similarly, poem is systematic arrangement of verses.

| ANALOGY OR SIMILARITY |

133. (1) Fishes live in water while birds fly in the sky. Similarly, submarine floats under water and aeroplanes fly in the sky.
134. (1) Scissors is used to cut cloth. Similarly, axe is used to chop wood.
135. (4) Wrist is the part of body between the hand and the arm. Similarly, ankle is the joint connecting the foot with leg.
136. (2) Rat is prey of Cat. Similarly, worm is prey of bird.
137. (1) Here **worker and raw material** relationship has been shown. Goldsmith works on gold. Similarly, Carpenter works on wood.
138. (2) Druggist (Pharmacist) is responsible for preparing and dispensing of drugs (Pharmacy). Similarly, Librarian prepares catalogue
139. (3) Car is kept in Garage. Similarly, aeroplane is kept in Hangar.
140. (1) Cruel and kind are antonymous to each other. Similarly, Humility and Arrogance are antonymous to each other.
141. (1) Goldsmith uses gold as raw material. Similarly, tanner uses leather as raw material.
142. (1) Bee is an insect. Similarly, man is a mammal.
143. (3) Date is given in calendar. Similarly words are arranged in alphabetical order in Dictionary.
144. (3) Editor is the overall incharge of a magazine. Similarly, a drama is played under the supervision of Director.
145. (3) Hinduism, Christianity and Islam are different religions. Similarly, Winter, Spring and Summer are different seasons.
146. (3) Poet writes poem. Similarly, Dramatist writes play.
147. (3) Handsome is used for man. Similarly, Beautiful is used for woman.
148. (4) Here Worker – Tool relationship has been shown. The tool of mechanic is spanner. Similarly, the tool of carpenter is saw.
149. (2) Grain is stored in warehouse. Similarly, water is stored by constructing dam.
150. (2) Hunger is quenched with food. Similarly, Disease is ward off with medicine.
151. (2) Thin and Thick are antonymous to each other. Similarly, Dwarf and Tall are antonymous to each other.
152. (4) The story of a man is called Biography. Similarly, the story of a nation is called History.
153. (3) Crop is grown in the farm. Similarly, Ore is extracted from mine.
154. (3) Dog is causative organism of Rabies. Similarly, Mosquito is causative organism of Malaria.
155. (4) Clock shows time. Similarly, thermometer shows temperature.
156. (2) Doctor treats patient. Similarly, Lawyer serves client.
157. (3) Victory gives encouragement. Similarly, failure results in frustration.
158. (3) Dog is a canine animal. Similarly, horse is a hoofed animal.
159. (2) The young one of frog is called tadpole. Similarly, the young one of lion is called cub.
160. (3) Mason uses bricks to construct buildings. Similarly, Painter uses colour to make art-pieces.
161. (1) Sleeping is a mode of taking rest. Similarly, one plays for enjoyment.
162. (4) We feel hungry when we do not eat, i.e., fasting. Similarly, we feel tired after running.
163. (1) Synonym and Antonym represent opposite meaning to each other. Similarly, Synthesis is opposite in meaning to Analysis.
164. (2) Saw is the tool of Carpenter. Similarly, Scissors are used by Tailors.
165. (1) Here, animal and its child relation has been shown. The young one of human is called child. The young one of lion is called cub.
166. (3) Copper is a good conductor of heat and electricity. Wood is a bad conductor of electricity.
167. (4) Lava is erupted from a Volcano. Similarly, fire emits ashes.
168. (1) Necklace is used for adornment. Similarly, Medal is a Decoration.
169. (4) Black is opposite of White. Similarly, Up is opposite of Down.
170. (3) Book is written by Author. Similarly, Statue is carved by Sculptor.
171. (3) 'Life' is opposite in meaning to 'Death'. Similarly, 'Hope' is opposite in meaning to 'Despair'.
172. (4) Christian and Muslim represent people of two different religions. Bible is the holy epic of Christians and Quran is the holy epic for Muslims.
173. (3) 'Large' and 'Enormous' are similar in meaning. 'Plump' and 'Fat' are similar in meaning.
174. (2) 'Life' is opposite in meaning to 'Death'. Similarly, 'Beginning' is opposite in meaning to 'End'.
175. (3) 'Leg' is analogous to 'Arm' and 'Knee' is analogous to 'Elbow'.
176. (2) **Interrupt (Verb)** means 'to stop the continuous progress of something temporarily', 'to stop somebody speaking or doing something by speaking oneself or by causing some other sort of disturbance'.
- Intrude (Verb)** means 'to put oneself into a place or situation where one is not welcome', 'to disturb'.
177. (4) Here, the relation of opposite meaning has been shown. 'Love' is opposite in meaning to Hate. Similarly, Friend is opposite in meaning to Enemy.
178. (1) Unemployment results into poverty. Unemployment and poverty are related words. Malnutrition causes Anaemia.
179. (2) 'Encourage' is opposite in meaning to 'Restrict'. Similarly, Dearth : is opposite in meaning to 'Surplus'.
180. (3) 'Defy' is opposite in meaning to 'Obey'. Similarly, 'Rest' is opposite in meaning to 'Labour'.
181. (1) We can move in water by swimming. Similarly, we can move on land by walking.
182. (1) Doctor gives advice to patients. Similarly, Advisor gives guidelines to students.
183. (1) The hoof of horse is analogous to foot of man.
184. (4) After night comes morning. Similarly, after evening comes night.
185. (3) Oxygen helps in burning. Carbon dioxide extinguishes fire.

| ANALOGY OR SIMILARITY |

186. (3) 'Yes' is opposite in meaning to 'No'. Similarly, 'Alive' is opposite in meaning to 'Dead'.
187. (3) Today → Yesterday → Day before Yesterday  
January → December → November
188. (2) Man lives in House. Similarly, Beast lives in Den.
189. (4) Here Diet-Animal relationship has been shown. Fodder is the food of cattle. Similarly, grass is food of horses.
190. (2) Stammering is the defect of speech. Similarly, deafness is the defect of hearing.
191. (4) RIGHT is opposite of WRONG. Similarly, PLEASURE is opposite of DISPLEASURE.
192. (1) Son and Nephew are males. Similarly, Daughter and Niece are females.
193. (3) Ring (Ear ring) is worn in the ear. Similarly, bangle is put on wrist.
194. (2) Wod pulp is the basic raw material used in the production of paper. Similarly, steel is used to make nail.
195. (2) Sun can be seen in day time. Similarly, moon appears in night.
196. (1) Gold is used to make jewellery. Similarly, wood is used to make furniture.
197. (2) One who writes novel is called author. Similarly, Choreographer organises dance.
198. (4) Carbohydrate is required for human body. Similarly, Petrol is required for engine.
199. (4) Mobile Phone is wireless telephone and it is portable. It can be carried away easily. Similarly, laptop is portable computer.
200. (1) We take food to satiate hunger. Similarly, we sleep to ward off weariness.
201. (4) Sapling grows into tree. Similarly, girls matures into a woman.
202. (2) Here Worker and Working place relationship has been shown. The working place of doctor is hospital. Similarly, Chef cooks meal in the kitchen.
203. (2) Hen lays egg and egg develops into its offspring. Similarly, tree produces seeds which germinate into sapling.
204. (3) Nail Cutter is used to clip nails. Gillete is a brand name of a razor.
205. (4) Pane is smaller compartment or side of a window. Similarly, pages are components of a book.
206. (4) Mattress is spread over cot. Similarly, carpet is spread over floor.
207. (2) The excess intake of salt causes hypertension. Similarly, high sugar in blood causes diabetes.
208. (3) Prologue is just opposite in meaning to Epilogue. Similarly, the early morning is called Dawn and early evening is referred to as Twilight.
209. (3) Bar chart is referred to as Histogram. Histogram is a chart consisting of rectangles. The art of hand-writing is referred to as Calligraphy.
210. (4) Ear is attached to Temple. Hand is attached to shoulder. Similarly, Tooth remains attached with Gum.
211. (3) Pea-hen is feminine gender of Pea-cock. Similarly, Bitch is feminine gender of Dog.
212. (3) Manipuri is the classical dance form of Manipur. Similarly, Kathakali is the Classical dance form of Kerala.
213. (1) Teacher teaches students. Similarly, Pontiff trains disciples.
214. (4) The sound of Bees is called Hum. Similarly, the sound made by Owl is called Hoot.
215. (3) Confirmed and Inveterate are related terms. Similarly, Financial and Bankrupt are related terms.
216. (1) Bench comes under the class Furniture. Similarly, Pen is a stationery item.
217. (3) Coal is referred to as Black Diamond. Similarly, Petroleum is called Liquid Gold.
218. (4) Poster is fixed on the wall. Similarly, Photograph is fixed in the Frame.
219. (2) tide ⇒ edit  
Reverse order of letters.  
Similarly,  
spit ⇒ tips
220. (3) Poet composes poetry by imagining something. Historian gathers facts to reconstruct the story of past.
221. (3) Gifted and Intelligent are synonymous to each other. Similarly, Creative and Productive are synonymous to each other.
222. (2) Triangle consists of three straight lines. Hexagon consists of six lines. Similarly, rectangle consists of four lines and that of Octagon consists of eight lines.
223. (4) Students carry and study books. Similarly, Postman carries mails.
224. (2) Illiteracy is warded off through education. Similarly, Drought is warded off by rain.
225. (3) Carpenter makes furniture. Similarly, Cook prepares soup. In this problem Worker-Product relationship has been shown.
226. (4) Caffeine is present in coffee. Similarly, nicotin is present in Tobacco.
227. (3) Intimate is opposite in meaning to Unfamiliar. Similarly, Interested is opposite in meaning to Indifference.
228. (3) Oil is extracted from coconut. Similarly, juice is extracted from fruit.
229. (1) Symphony is a long complex musical composition for a large Orchestra. Composer composes music.  
Fresco is a picture painted on a wall or ceiling while the plaster is still wet.
230. (3) Tusk is either of a pair of very long pointed teeth that projects from the mouth of elephant and other animals.  
Beak is the hard pointed or curved part of a bird's mouth.
231. (2) The causative agent of small-pox is virus. Similarly. The causative agent of Typhoid is Bacteria.
232. (3) Kitchen is a room in the home where meals are cooked or prepared. Similarly, Leaf is the part of plant where photosynthesis takes places and food is manufactured for plants.
233. (3) Books are kept on shelf. Similarly, clothes are stored in wardrobe.
234. (3) Gramophone record is a thin circular piece of plastic on which sound, especially music, has been recorded. Video is the

| ANALOGY OR SIMILARITY |

process of recording, reproducing or broadcasting films on magnetic tape, i.e., video cassette.

235. (4) Axe is used for chopping wood. Needle is used for knitting.
236. (2) The body of bird remains covered with feathers. Similarly, the body of fish remains covered with scales.
237. (3) A person is aroused in need. Similarly, effort is required to succeed.
238. (2) Wheat is a cereal. Similarly, water is a liquid.
239. (2) Up is antonym of Down. Similarly, Back is antonym of Front.
240. (3) The scientific study and exploration of Stars and other heavenly bodies is known as Astronomy. Similarly, the scientific study of the Earth and its interior is called Geology.
241. (3) We take rest in the state of fatigue (the condition of being very tired).  
Similarly, we drink water in the state of dehydration (the loss of water).
242. (2) Author writes book. Similarly, Tailor stitches shirt.
243. (2) Repel is the antonym of Attract. Similarly, Elastic is the antonym of Rigid.
244. (2) Umpire is a person in charge of a game who makes decisions during it and makes sure that the rules are obeyed. Moderator is a person who makes sure that participants are represented fairly in debate.
245. (1) The sound made by horse is called Neigh. Similarly, the sound made by a bell is called chime.
246. (2) Video is recorded in cassette. Similarly, Floppy is storage device used in computer.
247. (2) Glucometer is an instrument used to measure blood sugar. Similarly, Sphygmomanometer is used to measure blood pressure.
248. (2) Psychology is the study of human behaviour. Similarly, Botany is the scientific study of plants.
249. (1) Mitochondria is referred to as the powerhouse of the cell in which respiration and energy production occur. DNA is the unit of inheritance.
250. (1) Mirage is a phenomena of desert. Similarly, El Nino is the abnormal warming of surface ocean waters.
251. (1) Here Tool-Worker relationship has been shown. Chisel is the tool of Sculptor. Similarly, Harrow is the tool of Gardener.
252. (2) Moon is a Satellite. Earth is a Planet.
253. (2) Psychology is the science or study of the mind. Arithmetic is the branch of Mathematics that deals with computing of numbers (Addition, Subtraction, Multiplication and Division).
254. (3) Coldness is the property of Ice. Similarly, Gravitation is the property of Earth.
255. (4) Here Worker-Working place relationship has been shown. Teacher teaches in school. Similarly, Nurse looks after patients in hospital.
256. (1) Carpenter makes window. Similarly, Sculptor makes statue, figure or objects by carving wood or stone.
257. (3) Cataract is a disease of eye. Cataract is a condition in which the eye lens becomes progressively opaque.  
Pyorrhoea is a disease of periodontal tissue causing shrinkage of the gums and loosening of teeth.  
Sinusitis is inflammation of a sinus. Sinus is a cavity of bone or tissue, especially in the skull connecting with the nostrils.  
Eczema refers to inflammation of the skin, with itching and discharge from blisters.
258. (4) Milk, butter, eggs, fish, cod liver oil, green vegetables, carrots, tomatoes, mangoes and sweet potatoes are sources of Vitamin A.  
Similarly, Citrous fruits such as, oranges, lemons, amla, tomatoes, and chillies are sources of Vitamin C.
259. (3) Wine is a fermented grape juice used as an alcoholic drink. Whiskey refers to a spirit distilled especially from malted barley (oats).
260. (1) **Defer** means 'to delay something until a later time', 'to postpone'.

**Put off** means 'to put something to a later time or date,' 'to delay'. Thus, **Defer** and **Put off** are synonymous to one another.

**Deduce** means 'to infer', 'to arrive at facts'.

**Infer** means 'to arrive at a conclusion'.

261. (3) 'Gill' is the opening on the side of a fish's head through which it breathes.  
'Nose' is the part of the face above the mouth, used for breathing and smelling.
262. (1) A king sits in a throne. Similarly, a rider sits on a saddle on the back of a horse.
263. (3) Tanning is the process of manufacturing leather. Similarly, Pyrotechnics is the process of manufacturing fireworks.
264. (1) Victory is joyful. Similarly, defeat is sorrowful.
265. (2) Stomach is a part of body. Similarly, library has different kinds of books.
266. (4) Sunderlal Bahuguna was the founder of Chipko Movement. Similarly, Medha Patkar leads the Narmada Bachao Andolan.
267. (1) Jute growing areas lie along the Hooghly river.  
Similarly, Ahmedabad is related to cotton production.
268. (2) Rain is related to agriculture. Similarly, market is related to economy.
269. (3) Teacher teaches students. Similarly, lawyer serves his client.
270. (3) The first belongs to the second. Mango is a fruit. Similarly, Jasmine is a flower.
271. (2) Dress is prepared by tailor. Similarly, furniture is manufactured by carpenter.
272. (1) Bow and Arrow are complementary to each other. Similarly, Pistol and Bullet are complementary to each other.
273. (3) The second develops into the first. Seed germinates to give rise plant. Similarly, Bud develops into flower.
274. (1) Editor edits and supervises the articles of a magazine. Similarly, Director directs the scenes of a drama.

| ANALOGY OR SIMILARITY |

275. (4) The second belongs to the first. Dictionary is a reference material. Similarly, Newspaper is a periodical.
276. (3) The first is contained or served in the second. Tea is served in the cup. Similarly, soup is served in the bowl.
277. (3) The flesh of sheep is called mutton. Similarly, the flesh of deer is called venison.
278. (1) A Cobbler makes shoes with leather. Similarly, tailor stitches cloth.
279. (1) Saint seeks peace and solace through meditation. Similarly, scientist does research to establish some principles.
280. (4) Palace is living place of king. Similarly, Eskimo lives in Igloo. Igloo is the dome-shaped dwelling unit built of blocks of snow.
281. (4) Erosion destroys soil by means of rain, wind, streams etc. Similarly, deforestation refers to the loss of forest.
282. (2) Plane is temporarily parked in the Hangar. Similarly, car is parked in the garage.
283. (2) Cotton is a natural fibre while nylon is an artificial fibre.
284. (3) Punishment is given for a crime. Similarly, honesty is rewarded considerably.
285. (2) Loss of memory is referred to as Amnesia. Similarly, loss of movement is referred to as Paralysis.
286. (4) Vigilant is a synonym of Alert. Similarly, Viable and Feasible are synonymous with each other.
287. (1) Embarras (Verb) means 'to make somebody feel awkward, ashamed'.  
Frighten means 'to fill somebody with fear, to make somebody afraid'.  
Terrify means 'to make somebody very frightened.'
288. (1) Macabre is just opposite to Lovely. Similarly, Baneful is just opposite to unharmed.
289. (2) Demographer studies the changing numbers of births, deaths, housing, civic amenities etc in a community over a period of time. In other words, a demographer collects various data about people. Similarly, Philatelist is a person who collects or knows a lot about postage stamps.
290. (2) Sepal is leaf like part which supports the petals of a flower. Similarly, tyres of a bicycle are the outer most parts on which bicycle rests.
291. (2) Seismometer (Seismograph) is a scientific instrument for measuring the intensity of earthquakes. Similarly, thermometer is used for measuring temperature.
292. (3) Actors take part in play. Similarly, musicians perform concert. Concert is a musical entertainment given in public by one or more musicians. Play is a work written to be performed by actors.
293. (3) Here country-currency relationship has been shown. Deutsche Mark is the currency of Germany. Dirham is the currency of Morocco.
294. (4) Red Blood Cells are also called Erythrocytes. Similarly, White Blood Cells are called Leucocytes.
295. (3) The spacecraft landed on moon was named Chandrayan by the Indian space Research Organisation. Similarly, the spacecraft which landed on Mars in 2014 was named Mangalyan.
296. (4) Forest is the habitat of Lion. Similarly, water body is the habitat of fish.
297. (2) The causative organism of polio is virus. Similarly, the causative organism of anthrax is bacteria.
298. (3) Tributary is a part of river. Similarly, branch is a part of tree and is analogous to tributary in the case of river.
299. (4) Maharashtra is a state of India. Similarly, Texas is a constituent of USA.
300. (2) Qualm causes nausea. Similarly, burn causes sear.
301. (3) Cardiologist studies and examine the functions and ailments of heart. Similarly, Nephrologist studies and examines functions and ailments of kidney.
302. (3) Here Worker-Working place relationship has been shown. Doctor attends patients in hospital or clinic while teacher teaches in school.
303. (2) First Prime Minister of India was Pt. Jawaharlal Nehru while the first President of India was Dr. Rajendra Prasad.
304. (1) International Literacy Day is celebrated on September 8 every year. Similarly, International Women's Day is celebrated on March 8.
305. (3) Ravishankar was a great exponent of sitar. Similarly, Bismillah Khan is a famous Shehnai player.
306. (2) India is famous for mango. Similarly kiwis are found in New Zealand.
307. (4) Christmas is celebrated with cake and sweets. Id-ul-Fitr is celebrated with Biryani.
308. (3) Sea sickness is caused due to voyage. Similarly, Giddiness is caused when one climbs up (Heights).
309. (3) Here, Worker-Working Place relationship has been shown. Waitress works in Restaurant. Similarly, teacher teaches in school.
310. (4) Violin is a musical instrument with strings. Similarly, Piano is a large musical instrument played by pressing the black or white keys of a keyboard.
311. (3) Picture is set in a frame. Similarly, book is protected with cover.
312. (2) Bihu is celebrated in Assam. Similarly, Onam is celebrated in Kerala.
313. (3) Cataract affects eye. Similarly, Pneumonia affects lungs.
314. (2) Whale is a mammal. Similarly, Turtle is a reptile.
315. (3) **Dominance** bears the same meaning as that of **Hegemony**. Similarly, **Independence** bears the same meaning as that of **Autonomy**.
316. (1) The letters have been written in the reverse order.  
STAR ⇒ RATS  
Similarly,  
WARD ⇒ DRAW
317. (4) Ophthalmologist is a person who is specialised in eye and its diseases. Similarly, composer is a person who composes music.
318. (2) GER - MANY ⇒ GERMANY  
Similarly,  
IRE - LAND ⇒ IRELAND  
Both Germany and Ireland are European countries.

| ANALOGY OR SIMILARITY |

319. (4) Haematology is that branch of science which deals with blood and its disorder.  
Similarly, Phycology is that branch of science which deals with algae.
320. (1) Palaeontology is that branch of science which deals with fossils. Phrenology is the study of the shape and size of the cranium (skull).
321. (4) Etymology is the study of the origin and history of words and their meanings.  
Psychology is the study of mind. Anatomy is the scientific study of the structure of human or animal bodies.  
Archaeology is the study of antiques.  
Philosophy means the search for knowledge and understanding of the nature; a set of beliefs etc. but not of language.  
Hence it is different.
322. (1) Garbage is domestic waste material. Similarly, Gangue is waste material of ore.
323. (4) Nephron is the basic structural and functional unit of the kidney. Similarly, neuron is the basic structural and functional unit of the Central Nervous System.
324. (2) Entomology is that branch of science which deals with insects. Similarly, the scientific study of snakes is called ophiology.
325. (1) The raw material of book is paper. Similarly, the raw material of bread is flour.
326. (3) Hot is antonym of cold. Similarly, light is antonym of dark.
327. (3) The natives of France are called French. Similarly, the natives of Holland are called Dutch.
328. (3) Library is a building or room in which collections of books, newspapers, journals etc. are kept. Similarly, forest is a large area of land thickly covered with trees, bushes etc.
329. (4) Joker is an additional card in a pack of cards. Similarly, Cover is an additional part of a book.
330. (4) Money is carried in the wallet. Similarly, Letter is carried in an envelope.
331. (3) Cardiologist is a physician specialised in heart and its diseases. Neurologist is specialised in brain and nervous system.
332. (3) Car is parked in Garage. Similarly, aeroplane is parked in Hangar.
333. (4) Governor is the chief Executive Head of the state in the Indian Union. Similarly, the president is the constitutional head of the Republic of India (country).
334. (4) Vacation and Holiday bear the similar meaning. Similarly, Vocation and Career bear the similar meaning.
335. (3) Tears come out of the eyes. Similarly, Lava erupts from the Volcano.
336. (4) Perch is found in fresh water. Similarly, cod is found in salty water. The two most important species of cod are the Atlantic cod and the Pacific cod.
337. (1) The second is meant for the first. Gym is a room or hall with apparatus for physical exercise. Similarly, Restaurant is a place where meals are prepared, served and eaten.
338. (2) Here working place - worker relationship has been shown. Teacher teaches in school and banker manages bank.
339. (3) Fowler Bed is a special type of bed meant for patient. Similarly, cradle is small bed for baby.
340. (3) Feminine refers to a class of words that are female persons, animals etc. Similarly, Masculine refers to a class of words that are male persons, animals etc.
341. (2) Carpentry is considered to be a skill. Similarly, Singing is considered to be a talent.
342. (3) Concord and Agreement are synonymous to each other. Similarly, Discord and Conflict are synonymous to each other.
343. (3) Wings are parts of a fan, Similarly, spokes are parts of a wheel.
344. (1) Mathematics is based on logic. Similarly, experiments are mainstay of the Science.
345. (3) Pane is a part of Window. Similarly, pages are parts of a Book.
346. (4) Hockey is the National Game of India. Similarly, Baseball is the National Game of USA.
347. (3) Ant, Fly and Bee are small insects. Similarly, Hamster, squirrel and mouse are more or less similar small animals.
348. (4) A wall is constructed with the help of bricks. Similarly, cells constitute tissue.
349. (4) Coil is an important part of the motor. Similarly, bearing is an important part of wheel.
350. (2) The second is the tool of the first. Hammer is the tool of blacksmith. Similarly, forceps is the tool of Surgeon.
351. (1) Bullock pulls cart. Similarly, Horse pulls Tonga.
352. (1) Inch and yard are units of length. Similarly, Ounce and quart are units of volume.  
Note that ounce is unit of weight, however an another unit fluid ounce is a unit of volume.
353. (1) Pesticides protect crops from insects and antiseptics protect wound from germs.
354. (1) Optimist is a person who is always hopeful and expects the best in all things and hence remains cheerful.  
Pessimist is a person who expects the worst to happen. Therefore, such person remains gloomy.
355. (2) **Prediction (Noun)** means a statement that says what you think will happen (in future).  
**Regret (Noun)** means a feeling of sadness or disappointment for committing some wrong or sin/ not doing something which has to be done.
356. (3) **Adversary** means a person that somebody is opposed to and competing with in an argument or a battle; opponent.  
**Enemy** means a person who hates somebody or who acts or speaks against somebody/something.  
**Adversity** means a difficult or unpleasant situation.  
**Difficulty** means a problem, a thing or situation that causes problems.
357. (3) Worm is the prey of Bird. Similarly, Mouse is the prey of Cat.
358. (4) Cytology is that branch of Biology which deals with cells and their functions. Similarly, Ornithology is the scientific study of birds.

| ANALOGY OR SIMILARITY |

359. (3) Both bird and aeroplane fly in the air. Similarly, fish and boat swim/ move in the water.
360. (2) Pilgrims undertake pilgrimage forming caravan. Similarly, rioters form gang to cause disturbances.
361. (4) The movement of horse is called gallop. Similarly, the movement of Lamb is called frisk.
362. (4) Farmer works in the field. Similarly, Engineer works at the site.
363. (1) Alluring and Beautiful are synonymous to each other. Similarly, Playful and Whimsical are synonymous to each other .
364. (4) The living place (Habitat) of pigs is called Sty. Similarly, the living place of dogs is called Kennel.
365. (1) Editor edits the articles, write-ups etc. of a magazine. Similarly, Director controls and directs scenes of a drama.
366. (1) Calorie and Joule are units of heat. Similarly, decibel is unit of sound.
367. (3) Brain is the organ of the body inside the head that controls thought, memory and feeling. It is found naturally.  
Computer is a device which performs a variety of functions and it is an example of artificial intelligence.
368. (2) The second term is a type of the first. Red is a colour. Similarly, English is a language.
369. (3) Bread is prepared by baking the dough. Similarly, curd is manufactured by the fermentation of milk.
370. (2) Happy is the antonym of Dismal. Similarly, Proud is the antonym of Humble.
371. (3) Powerful is antonym of weak. Similarly, victory is antonym of defeat.
372. (4) Students go to college to study different courses. Similarly, patients go to hospital for treatment.
373. (3) The sound made by Donkey is called Brays. Similarly, the sound made by Monkey is called Chatter.
374. (1) Head is a part of human body. Similarly, arc is a part of a circle.
- Here, 'Part-Whole' relationship has been shown.
375. (3) The scientific study of Fungi is called Mycology. Similarly, the scientific study of tissue is called Histology.
376. (1) Water flows continuously in the river but water remains stagnant in the pond.
377. (2) Disease is cured through medicine. Similarly, injury is healed through proper care.
378. (1) Psychology is the study of the mind (of human beings) and how it functions. Similarly, ornithology is the study of birds.
379. (2) The sound of owl is called Hoots. Similarly, the sound of hen is called clucks.
380. (1) Gibber is the sound produced by an ape. Similarly, Grunt is the sound produced by a camel.
381. (3) Cytology is that branch of Biology which deals with cell. Similarly, Ornithology is that branch of Biology which deals with birds.
382. (2) Actor performs a role of character in a play. Similarly, musician performs at a concert.
383. (4) 'Forecast' means a statement about what will happen in the future. Similarly, 'Regret' means a feeling of sadness or disappointment that has happened or not happened in the past.
384. (4) Bacteria are microorganisms which can be observed clearly with the help of a microscope. Similarly, moon is a distant heavenly body which can be observed minutely with the help of a telescope.
385. (4) Earth is a planet and Moon is a satellite.
386. (3) Sanitation is necessary to avoid illness. Similarly, care is required to avoid accident.
387. (2) Here worker - Function relationship has been shown. Aviator fly aeroplane. Similarly, Senator makes legislation.
388. (4) Peacock is the National Bird of India. Similarly, Bear is the National Animal of Russia.
389. (2) Second term is the unit of measurement of the first. Ampere is the unit of electric current. Similarly, Kilogram is the unit of weight.
390. (3) Foot of Man is analogous to Hoof of Horse.
391. (4) Grain is stored in warehouse. Similarly, water is stored by constructing dam.
392. (1) Coin is manufactured in mint. Similarly, bricks are made in kiln.
393. (3) Several pages together constitute a book. Similarly, wall is constructed with the help of bricks.
394. (2) A well arranged order of words makes a meaningful sentence. Similarly, several paragraphs together constitute an essay.
395. (4) Paw of Cat is analogous to Hoof of Horse.
396. (2) Jailor is the incharge of a jail and the prisoners in it. Similarly, Curator is a person in charge of a museum, an art gallery, etc.
397. (4) Preamble to the Constitution is the introduction to the Constitution containing basic philosophy of the Constitution. Similarly, Preface to a book summarises the main theme of the book.
398. (3) Poverty can be alleviated with the money. Similarly, illiteracy can be warded off through education.
399. (1) Birds fly in the air. Similarly, fish swims in water.
400. (1) Telescope is an instrument for viewing distant objects, such as stars, as magnified.  
Similarly, Periscope is an apparatus for viewing objects lying above the eye level of the observer, especially while travelling by ship.
401. (3) Here, Part : Whole relationship has been shown. Four lines make a square. Similarly, an arc is extended to form a circle.
402. (4) Rent is paid for accommodation. Similarly, fare is paid for journey.
403. (2) Aestivation means 'a state of inactivity and metabolic depression during summer.' Similarly, hibernation means 'a state of inactivity and metabolic depression during winter.'
404. (1) Calendar shows the dates. Similarly, Dictionary is a collection of words in a certain order.

405. (3) Pesticide protects plant from insects. Similarly, vaccination prevents baby from diseases.
406. (2) Fingers of hand are analogous to toes of feet.
407. (3) The second is the unit of measurement of the first. Metre is the unit of length. Similarly, Watt is the unit of power.
408. (2) Dark is antonym of Light. Similarly, Noise is antonym of Quiet.
409. (3) Medicine is administered to patient to cure him/her. Similarly, education is imparted to student to make him/her literate.
410. (4) Maharashtra is a State of India. Similarly, Texas is a province of USA.
411. (3) Yen is a currency. Similarly, Indian refers to Nationality.
412. (2) The day before today is called yesterday and the day after today will be tomorrow. Similarly, March comes before April and May comes after April.
413. (4) Sardar Vallabhbhai Patel is known as Iron Man of India. Similarly, Mahatma Gandhi is called Father of the Nation.

414. (3)

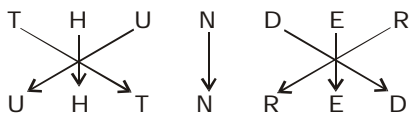

Similarly,

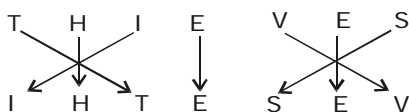

415. (4) In the game of football, scoring is done by kicking goal. Similarly, in the game of basketball, scoring is done through throwing ball into the basket.
416. (3) Pitch is an area of ground prepared and marked for the game of cricket. Similarly, Ring is an enclosed space in which the game of boxing is carried out.
417. (1) Nose is the part of the face above mouth. Similarly, finger is a part extending from palm.

**TYPE-II**

1. (3) **Given set** (3, 7, 15)  
1st Number + 4 = 2nd number  
2nd Number + 8 = 3rd number  
+ 4 = 7 and 7 + 8 = 15  
5 + 4 = 9 and 9 + 8 = 17
2. (3) **Given set**  
(3, 18, 36)  
3 × 6 = 18 and 18 × 2 = 36  
Similarly,  
(4, 24, 48)  
4 × 6 = 24 and 24 × 2 = 48
3. (4)  $\begin{matrix} 7 & 15 & 31 \\ \swarrow & \uparrow & \swarrow \\ & \times 2+1 & \end{matrix}$
- Similarly,  $\begin{matrix} 5 & 13 & 29 \\ \swarrow & \uparrow & \swarrow \\ & \times 2+3 & \end{matrix}$
4. (1)  $\begin{matrix} 63 & 49 & 35 \\ \downarrow & \downarrow & \downarrow \\ 7 \times 9 & 7 \times 7 & 7 \times 5 \end{matrix}$   
**Similarly,**  
 $\begin{matrix} 81 & 63 & 45 \\ \downarrow & \downarrow & \downarrow \\ 9 \times 9 & 9 \times 7 & 9 \times 5 \end{matrix}$
5. (2)  $2 \times 7 = 14$   
and,  $2 \times 8 = 16$   
Similarly,  
 $3 \times 7 = 21$   
 $3 \times 8 = 24$
6. (2) (6, 36, 63)
- $6 \times 6 = 36 \rightarrow 6 \times 3$
- Similarly,
- $8 \times 8 = 64 \rightarrow 4 \times 6$
7. (3) **Given set**  
 $4 + 6 = 10$  and  $10 + 5 = 15$   
Similarly,  
 $5 + 7 = 12$  and  $12 + 6 = 18$
8. (2) The differences between the consecutive numbers are 8, 16.
- $32 \underline{\hspace{1cm}} 24 \underline{\hspace{1cm}} 8$   
                  8                  16
- $24 \underline{\hspace{1cm}} 16 \underline{\hspace{1cm}} 0$   
                  8                  16
9. (3)  $5 + 4 = 9$  and  $9 + 7 = 16$   
Similarly,  $7 + 4 = 11$  and  
 $= 11 + 7 = 18$

10. (1)  $2+3 = 5$ ,  $5+1 = 6$ ,  $1+7 = 8$   
 $6 - 5 = 1$ ,  $8 - 6 = 2$   
 $2 + 9 = 11 \Rightarrow 1+1 = 2$   
 $5 + 7 = 12 \Rightarrow 1+2 = 3$   
 $1 + 4 = 5$   
 $3 - 2 = 1$ ,  $5 - 3 = 2$
11. (1)  $2 \times 5 = 10$   
 $10 \times 6 = 60$ ,  $60 - 2 = 58$   
 $4 \times 5 = 20$   
 $20 \times 3 = 60$ ,  
 $60 - 4 = 56$
12. (3) The consecutive numbers are given.
13. (2)  $17 + 13 = 30$  ;  $30 - 20 = 10$   
 $11 + 9 = 20$  ;  $30 - 20 = 10$
14. (4)  $6 \times 5 = 30$ ,  
 $30 \times 3 = 90$   
 $8 \times 6 = 48$ ,  
 $48 \times 4 = 192$
15. (2)  $6 + 8 = 14$   
 $14 + (8 \times 2) = 30$   
Similarly,  
 $7 + 5 = 12$   
 $12 + (5 \times 2) = 22$
16. (2)  $7 + 5 = 12$ ;  $12 + 10 = 22$ ;  
 $22 + 15 = 37$   
Similarly,  
 $3 + 5 = 8$ ;  $8 + 10 = 18$ ;  
 $18 + 15 = 33$
17. (1)  $10.5 + 4.5 = 15.0$ ;  
 $15.0 + 6.5 = 21.5$   
Similarly,  
 $32.5 + 4.5 = 37.0$ ;  
 $37.0 + 6.5 = 43.5$
18. (1)  $2 \times 5 = 10$ ;  $2 \times 14 = 28$   
 $4 \times 5 = 20$ ;  $4 \times 14 = 56$
19. (3) The numbers given in the Set are Perfect Squares.  
 $4 = (2)^2$ ;  $25 = (5)^2$ ;  
 $81 = (9)^2$   
Similarly,  
 $16 = (4)^2$ ;  $64 = (8)^2$ ;  
 $100 = (10)^2$
20. (3)  $8 \times 7 = 56$   
 $8 \times 9 = 72$   
Similarly,  
 $6 \times 7 = 42$   
 $6 \times 9 = 54$
21. (1)  $4 = (2)^2$   
 $9 = (2 + 1)^2 = (3)^2$   
 $25 = (3 + 2)^2 = (5)^2$   
Similarly,  
 $4 = (2)^2$   
 $25 = (5)^2$   
 $36 = (5 + 1)^2 = (6)^2$



**ANALOGY OR SIMILARITY**

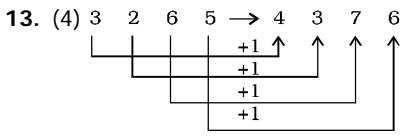

Similarly,

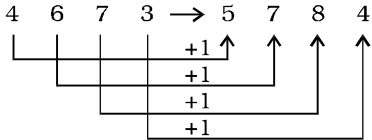

14. (3)  $(3)^3 - 3 = 27 - 3 = 24$   
 $(4)^3 = 4 = 64 - 4 = 60$   
 Similarly,  
 $(6)^3 - 6 = 216 - 6 = 210$   
 $(7)^3 - 7 = 343 - 7 = \boxed{336}$

15. (1)  $(6)^3 + 6 = 222$   
 Similarly,  
 $(7)^3 + 7 = 350$

16. (1)  $(5)^3 - 1 = 124$   
 Similarly,  $(7)^3 - 1 = 342$

17. (2)  $(19 \times 2) - 1 = 37$   
 Similarly,  
 $(26 \times 2) - 1 = 51$

18. (3)  $24 \times \frac{5}{2} = 60$

And,  $120 \times \frac{5}{2} = \boxed{300}$

19. (4)  $7 \times 7 + 1 = 50$   
 Similarly,  $11 \times 11 + 1 = 122$

20. (2)

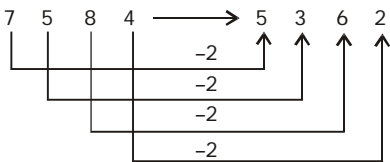

Similarly,

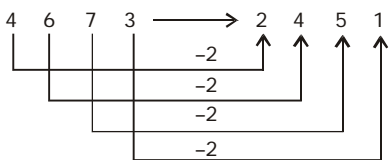

21. (3) 5 and  $(5 + 1)^2 = 36$   
 Similarly, 6 and  $(6 + 1)^2 = 49$

22. (1)  $210 = (15)^2 - 15$   
 $380 = (20)^2 - 20$   $\left. \begin{matrix} 15+5=20 \\ 20-5=15 \end{matrix} \right\}$

$182 = (14)^2 - 14$   
 $14 + 5 = 19$

Therefore,  $? = (19)^2 - 19$   
 $= 361 - 19 = 342$

23. (2)  $25 = 5 \times 5$   
 and  $37 = (5 + 1)^2 + 1$   
 $49 = 7 \times 7$

and  $? = (7 + 1)^2 + 1 = \boxed{65}$

24. (2)  $16 = 8 \times 2$ ;  $56 = 8 \times 7$   
 $32 = 16 \times 2$ ;  
 $? = 16 \times 7 = 112$

25. (2)  $9 \times 5 = 45$  and  $9 \times 4 = 36$   
 Similarly,  $9 \times 7 = 63$  and  
 $9 \times 6 = 54$

26. (1)  $42 - (7)^2 - 7 = 49 - 7$   
 $56 = (8)^2 - 8 = 64 - 8$

Similarly,  
 $110 = (11)^2 - 11 = 121 - 11$   
 Now,  $(12)^2 - 12 = 144 - 12 = 132$

27. (2)  $5 \times 20 = 100$ ,  $4 \times 16 = 64$   
 Similarly,  $4 \times 20 = 80$  and  
 $3 \times 16 = 48$

28. (1)  $42 = (7)^2 - 7 = 49 - 7$   
 $56 = (8)^2 - 8 = 64 - 8$

Similarly,  
 $132 = (12)^2 - 12 = 144 - 12$

Therefore,  
 $? = (13)^2 - 13 = 169 - 13 = 156$

29. (2) The second number is the square of the first number and the third number is obtained by subtracting first number from the second number.

$(11)^2 = 121$ , and  $121 - 11 = 110$   
 $(15)^2 = 225$ , and  $225 - 15 = 210$

Similarly,  
 $(19)^2 = 361$  and  $361 - 19 = 342$

30. (3)  $122 = (11)^2 + 1$   
 $145 = (12)^2 + 1$   
 $226 = (15)^2 + 1$   
 Therefore,  $? = (16)^2 + 1 = 257$

31. (4)  $2 \times 2 = 4$  and  $2 \times 4 = 8$   
 $10 \times 2 = 20$  and  $10 \times 4 = 40$   
 $\Rightarrow 3 \times 2 = 6$  and  $3 \times 3 = 9$

Therefore,  
 $15 \times 2 = 30$  and  $15 \times 3 = 45$

32. (3) We have  $5 \times (5 - 1) + 1 = 21$   
 Similarly,  $7 \times (7 - 1) + 1 = 43$

33. (2)  $4 \times 4 = 16$  and  $16 - 4 = 12$   
 Similarly,  
 $5 \times 5 = 25$  and  $25 - 5 = 20$

Alternatively,  
 $4 \times (4 - 1) = 12$   
 $5 \times (5 - 1) = 20$

34. (2)  $1 + 5 = 6$  and  $(6)^2 = 36$   
 $2 + 5 = 7$  and  $(7)^2 = 49$

35. (2)  $136 + 469 = 605$   
 $\therefore ? = 605 - 247 = 358$

36. (2)  $49 : 81$   
 $\downarrow \quad \downarrow$   
 $(7)^2 \quad (9)^2$

Similarly,

$64 : 100$   
 $\downarrow \quad \downarrow$

$(8)^2 \quad (10)^2$

37. (1)  $371 - 150 = 221$   
 $468 - 221 = 247$

38. (1)  $42 - 31 = 11$   
 $97 - 86 = 11$

39. (1)  $7 \times 2 + 3 = 17$   
 Similarly,  $23 \times 2 + 4 = 50$

40. (3)  $16 \times 3 = 48 \Rightarrow 1648$   
 $13 \times 3 = 39 \Rightarrow 1339$   
 $22 \times 3 = 66 \Rightarrow 2266$

Similarly,

$14 \times 3 = 42 \Rightarrow 1442$

41. (2) We have  
 $(12)^2 + 1 = 145$   
 $(14)^2 + 1 = 195$

Similarly,

$(4)^2 + 1 = 17$

$(6)^2 + 1 = 35$

42. (3)  $3222 \quad 3323$   
 $4000 \quad 4404$   
 $\overline{7222} \quad \overline{7727}$

43. (4)  $(1)^3 = 1$ ;  $(2)^3 = 8$

$(3)^3 = 27$ ;  $(4)^3 = \boxed{64}$

44. (4)  $5^2 - 1 = 24$ ;  $5^3 + 1 = 126$

$7^2 - 1 = 48$ ;  $7^3 + 1 = \boxed{344}$

45. (2)  $(2)^2 + 3 = 4 + 3 = 7$

Similarly,

$(6)^2 + 3 = 36 + 3 = 39$

46. (3)  $27 \times 3 = 81$

$24 \times 3 = 72$

47. (1)  $4 + 7 = 6 + 5 = 11$

$5 + 9 = 9 + 5 = 14$

48. (1)  $4 \times 5 = 20$ ;  $5 \times 6 = 30$

Similarly,

$7 \times 8 = 56$ ;  $8 \times 9 = 72$

49. (1) 3 4 2 → 4 5 3
-

**ANALOGY OR SIMILARITY**

Similarly,

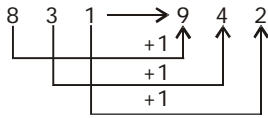

50. (1)  $30 \Rightarrow \boxed{1} 30$   
 Similarly, from given options  
 $20 \Rightarrow \boxed{1} 20$
51. (2)  $520 = 8 \times 8 \times 8 + 8 = 512 + 8$   
 $738 = 9 \times 9 \times 9 + 9 = 729 + 9$   
 $350 = 7 \times 7 \times 7 + 7 = 343 + 7$   
 $\therefore ? = 6 \times 6 \times 6 + 6 = 216 + 6 = 222$
52. (3)  $423 + 234 = 657$   
 $534 + 234 = 768$
53. (4)  $1 + 3 = 4; 2 + 4 = 6$   
 $6 - 4 = 2$   
 $5 + 7 = 12; 6 + 8 = 14$   
 $14 - 12 = 2$
54. (3)  $24 \times 2.5 = 60$   
 $120 \times 2.5 = 300$
55. (3)  $14 \times 14 \times 2 = 392$   
 $14 \times 2 = 28$   
 Similarly,  
 $19 \times 19 \times 2 = 722$   
 $19 \times 2 = \boxed{38}$
56. (4)  $1 + 2 + 3 = 6; (6)^2 = 36$   
 $2 + 2 + 1 = 5; (5)^2 = 25$
57. (3)  $6 = 2 \times 3$  and  $2 + 3 = 5$   
 $8 = 2 \times 4$  and  $2 + 4 = \boxed{6}$
58. (3)  $0 + 8 = 2 + 6$   
 So from given options  
 $1 + 8 = 6 + 3$
59. (2)  $7 + 2 = 9;$   
 $5 + 3 = 8$   
 $9 - 8 = 1$   
 $6 + 4 = 10;$   
 $10 - 9 = 1$   
 So first ratio :  
 $5 + 4 = \boxed{9}$
60. (2)  $17 \times 3 + 9 = 51 + 9 = 60$   
 Similarly,  
 $20 \times 3 + 9 = 60 + 9 = 69$
61. (2)  $(6 + 2)^2 = (8)^2 = 64$   
 Similarly,  $(11 + 2)^2 = (13)^2 = \boxed{169}$
62. (4)  $123 \Rightarrow 12 \div 3 = 4$   
 Similarly,  $726 \Rightarrow 72 \div 6 = \boxed{12}$

63. (2)  $8 - 3 = 5; (5)^2 = 25$   
 Similarly,  
 $9 - 2 = 7; (7)^2 = \boxed{49}$
64. (2)  $1 + 5 = 6$   
 $8 + 5 = 13$
65. (4) Two logics may be applied here:  
 $3, 1, 2, 2$  So,  $0, 2, 3, 3$   
 $\downarrow$  Squaring  $\downarrow$  Squaring  
 $9, 1, 4, 4$   $\boxed{0, 4, 9, 9}$   
 This answer is not given in options.  
 Now the second logic :  
 $3, 1, 2, 2$  So,  $0, 2, 3, 3$   
 $\times 3 \downarrow \times 1 \downarrow \times 2 \downarrow \times 2 \downarrow$   $\times 3 \downarrow \times 1 \downarrow \times 2 \downarrow \times 2 \downarrow$   
 $9, 1, 4, 4$   $\boxed{0, 2, 6, 6}$   
 Which is given in option (4).
66. (4) The second number is the square of the first number.  
 $(5.5)^2 = 30.25$   
 Similarly,  
 $(11.0)^2 = 121.00$
67. (1)  $8 \times 2.5 = 20$   
 Similarly,  
 $14 \times 2.5 = 35$
68. (2) The second number is the perfect cube of the first number  
 $(3)^3 = 3 \times 3 \times 3 = 27$   
 Similarly,  
 $(5)^3 = 5 \times 5 \times 5 = 125$
69. (2)
- 
- Similarly,
- 
70. (2)  $856 - 763 = 93$   
 Therefore,  
 $? = 637 + 93 = \boxed{730}$
71. (3)  $3 + 6 = 9$  and  $3 + 2 + 4 = 9$   
 Similarly,  
 $4 + 9 = 13$  and  
 $4 + 1 + 4 + 4 = 13$
72. (2)  $(7)^2 = 49$  and  $(7 + 2)^2 = 81$   
 Similarly,  
 $(8)^2 = 64$  and  $(8 + 2)^2 = 100$

73. (3)  $(3)^3 = 27$  and  $(3)^2 = 9$   
 Similarly,  
 $(4)^3 = 64$  and  $(4)^2 = 16$
74. (3)  $(9)^2 = 81 - 1 = 80$   
 Similarly,  
 $(100)^2 = 10000 - 1 = 9999$
75. (\*) Two logics can be applied to this question :  
 $11 \times 3 + 5 = 38$   
 $\Rightarrow 13 \times 3 + 5 = 44 \rightarrow$  option (2)  
 again from IInd logic :  
 $11 \times 4 - 6 = 38$   
 $\Rightarrow 13 \times 4 - 6 = 46 \rightarrow$  option (4)
76. (2)  $3 \times 6 = 18$  and  $13 \times 6 = 78$
77. (2)  $(10)^2 - 1 = 100 - 1 = 99$   
 Similarly,  
 $(09)^2 - 1 = 81 - 1 = 80$
78. (2)  $37 - 14 = 23$   
 Similarly,  
 $19 - 14 = 5$
79. (1)  $13 - 8 = 5$   
 Similarly,  $32 - 8 = 24$
80. (2)  $2 \times 4 = 8$  [First number]  
 Similarly,  $2 \times 3 = 6$
81. (4)  $76 \Rightarrow 7 \times \frac{6}{2} \times \left(\frac{6}{2} + 1\right) - 1$   
 $\Rightarrow 7 \times 3 \times 4 - 1 = 83$   
 Similarly,  
 $42 \Rightarrow 4 \times \frac{2}{2} \times \left(\frac{2}{2} + 1\right) - 1$   
 $\Rightarrow 4 \times 1 \times 2 - 1 = 7$
82. (1)  $149 + 89 = 238$   
 Similarly,  
 $159 + 89 = 248$
83. (1)  $6 + 3 = 9$  and  $6 + 8 = 14$
84. (2)  $2 + 4 + 3 + 1 = 10$   
 And,  $\frac{10}{2} = 5$   
 Similarly, From given options  
 $5 + 4 + 6 + 1 = 16$   
 And,  $\frac{16}{2} = 8$   
**IInd Logic :**  
 $\frac{5}{5} : \frac{2+4}{2+4} \quad \frac{3+1}{3+1}$   
 $\frac{+1}{+1}$   
 So from given options  
 $\frac{8}{8} : \frac{5+4}{5+4} \quad \frac{6+1}{6+1}$   
 $\frac{+1}{+1}$   
 So, 5461 is correct answer.

**ANALOGY OR SIMILARITY**

85. (2) 49 : 81  
 $\downarrow$                      $\downarrow$   
 (7)<sup>2</sup>                  (7+2)<sup>2</sup>  
 Similarly,  
 100 : 144  
 $\downarrow$                      $\downarrow$   
 (10)<sup>2</sup>                (10+2)<sup>2</sup>

86. (2) (4)<sup>2</sup> + 3 = 19  
 Similarly, (7)<sup>2</sup> + 3 = 52

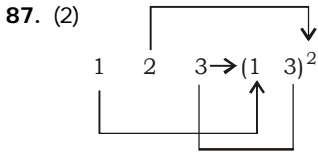

Similarly,

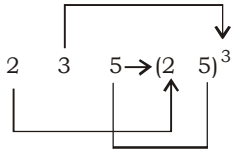

88. (3)

27 : 125 : : 64 : 216  
 $\downarrow$                      $\downarrow$                      $\downarrow$                      $\downarrow$   
 (3)<sup>3</sup>                  (3+2)<sup>3</sup>                  (4)<sup>3</sup>                  (4+2)<sup>3</sup>

89. (2) (10)<sup>2</sup> - 1 = 99  
 Similarly,  
 (9)<sup>2</sup> - 1 = 80

90. (2) 11-1 = 10 and  $\frac{10}{2} = 5$   
 Similarly, 17 - 1 = 16 and  
 $\frac{16}{2} = 8$

91. (2) (0.01)<sup>2</sup> = 0.0001  
 Similarly, (0.05)<sup>2</sup> = 0.0025

92. (1) 2 is replaced with 8.  
 Therefore, 1221  $\Rightarrow$  1881

93. (2) 19  $\times$  3 + 2 = 59  
 Similarly, 17  $\times$  3 + 2 = 53

94. (1) 7  $\times$  2 = 14  
 and, 7  $\times$  3 - 1 = 20  
 Similarly, 8  $\times$  2 = 16  
 and 8  $\times$  3 - 1 = 23

95. (1) 100 = (10)<sup>2</sup> = 10  $\times$  10  
 Similarly, 100000 = 10<sup>5</sup>

96. (4) (10)<sup>2</sup> + 1 = 100 + 1 = 101  
 (20)<sup>2</sup> + 1 = 400 + 1 = 401

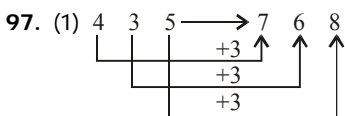

Similarly,

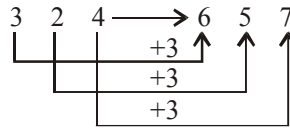

98. (2) (11)<sup>2</sup> = 121; 121 - 11 = 110  
 (15)<sup>2</sup> = 225; 225 - 15 = 210

Similarly,

(19)<sup>2</sup> = 361; 361 - 19 = 342

99. (4) 16 = (4)<sup>2</sup>; 49 = (4 + 3)<sup>2</sup>

Similarly,

100 = (10)<sup>2</sup>

$\therefore ? = (10 + 3)^2 = 169$

100. (2) 15  $\times$  15 - 5 = 220  
 25  $\times$  25 - 5 = 620

101. (3)  $\sqrt{400} = 20$

Similarly,

$\sqrt{484} = 22$

102. (1) 4  $\times$  4  $\times$  2 = 32

Similarly,

7  $\times$  7  $\times$  2 = 98

103. (3) The number has been written in reverse order.

104. (2) (11)<sup>2</sup> - 2 = 121 - 2 = 119

Similarly,

(15)<sup>2</sup> - 2 = 225 - 2 = 223

105. (2) 21  $\div$  7 = 3

Similarly,

574  $\div$  7 = 82

106. (2) (2)<sup>3</sup> - 8 = 8 - 8 = 0

Similarly,

(3)<sup>3</sup> - 8 = 27 - 8 = 19

107. (3) 8 - 3 = 5;

5  $\times$  5 = 25

9 - 2 = 7;

7  $\times$  7 = 49

108. (1) (6)<sup>2</sup> - 1 = 36 - 1 = 35

Similarly,

(7)<sup>2</sup> - 1 = 49 - 1 = 48

109. (1) 4 + 20 = 24

Similarly,

17 + 20 = 37

110. (1) 3  $\times$  6  $\times$  5 = 90

Similarly, 6  $\times$  2  $\times$  3 = 36

111. (3)  $\frac{24}{8} = 3$ ;  $\frac{32}{8} = 4$

112. (3) 212 + 224 = 436

560 + 224 = 784

113. (1) 7  $\times$  7 - 1 = 49 - 1 = 48

12  $\times$  12 - 1 = 144 - 1 = 143

114. (2) 7 + 2 = 9 and 9  $\times$  2 = 18

5 + 6 = 11 and 11  $\times$  2 = 22

115. (3) 6 + 21 = 27 = 3  $\times$  3  $\times$  3

3 + 61 = 64 = 4  $\times$  4  $\times$  4

116. (1) 34  $\times$  2 = 68;

34  $\times$  3 + 28 = 130

105  $\times$  2 = 210;

105  $\times$  3 + 35 = 350

117. (1)

$\frac{128}{8} = 16$ ;  $\frac{96}{6} = 16$   $\frac{244}{8} = 30.5$ ;

30.5  $\times$  6 = 183

118. (2) 85 - 1 = 84; 84  $\div$  2 = 42

139 - 1 = 138; 138  $\div$  2 = 69

119. (4) (2)<sup>3</sup> = 2  $\times$  2  $\times$  2 = 8

28 = (3)<sup>3</sup> + 1 = 3  $\times$  3  $\times$  3 + 1 = 28

(3)<sup>3</sup> = 3  $\times$  3  $\times$  3 = 27

$\therefore ? = 4 \times 4 \times 4 + 1 = 65$

120. (4) 5  $\times$  5 + 5 = 25 + 5 = 30

Similarly, 7  $\times$  7 + 7 = 49 + 7 = 56

121. (4) 7  $\times$  5 - 3 = 35 - 3 = 32

35  $\times$  5 - 3 = 175 - 3 = 172

122. (3) 64 = 8  $\times$  8;

100 = 10  $\times$  10

Similarly

49 = 7  $\times$  7

81 = 9  $\times$  9

123. (1) (5)<sup>2</sup> = 25

(9)<sup>2</sup> = 81

Similarly,

(6)<sup>2</sup> = 36

(11)<sup>2</sup> = 121

124. (3)  $\frac{292}{2} = 146$

Similarly,  $\frac{582}{2} = 291$

125. (2)  $6 \times \frac{6}{2} = 18$

Similarly,  $4 \times \frac{4}{2} = 8$

126. (4) 3  $\times$  3  $\times$  3 = 27

Similarly, 7  $\times$  7  $\times$  7 = 343

127. (4) 9  $\times$  3 + 1 = 27 + 1 = 28

Similarly,

56  $\times$  3 + 1 = 168 + 1 = 169

128. (4) 12  $\times$  3 - 1 = 36 - 1 = 35

Similarly,

16  $\times$  4 - 1 = 64 - 1 = 63

129. (2) 3  $\times$  3  $\times$  3 = 27

Similarly,

4  $\times$  4  $\times$  4 = 64

**ANALOGY OR SIMILARITY**

130. (1)  $18 \times 3 - 2 = 54 - 2 = 52$

Similarly,

$12 \times 3 - 2 = 36 - 2 = 34$

131. (3)  $(2)^3 = 8$

$2 + 1 = 3$  and  $(3)^2 = 9$

Similarly,

$(4)^3 = 64$

$4 + 1 = 5$  and  $(5)^2 = 25$

132. (3)  $16 = (4)^2$ ;  $4 - 2 = 2 \Rightarrow (2)^2 = 4$

Similarly,

$9 = (3)^2$ ;  $3 - 2 = 1$

$\Rightarrow (1)^2 = 1$

133. (2)  $27 = (3)^3$ ;

$9 = (3)^2$

Similarly,

$125 = (5)^3$ ;  $25 = (5)^2$

134. (2)  $(5)^2 = 25$

$(5)^3 = 125$

Similarly,

$(5)^4 = 625$

$(5)^5 = 3125$

135. (1)  $196 = (14)^2$ ;  $169 = (13)^2$

Similarly,

$81 = (9)^2$ ;  $(8)^2 = 64$

136. (3) There are three similar digits for the three digit number. Therefore, there would two similar digits for two-digit number.

$130 \Rightarrow 222$

$30 \Rightarrow 66$

137. (2)  $4 \times 4 = 16$

The product of the first and the last numbers is equal to the middle number in each term.

$2 \times 2 = 4$ ;  $3 \times 3 = 9$

Therefore,

$? = 9 \times 9 = 81$

138. (4)  $6524 - 6465 = 59$

$9638 - 59 = 9579$

139. (3)  $64 = 8 \times 8$

$144 = 12 \times 12$

$256 = 16 \times 16$

$400 = 20 \times 20$

140. (2)  $3 \times 3 - 1 = 9 - 1 = 8$

$3 \times 3 \times 3 + 1 = 27 + 1 = 28$

$4 \times 4 - 1 = 16 - 1 = 15$

$4 \times 4 \times 4 + 1 = 64 + 1 = 65$

141. (3)  $\sqrt{625} = 25$ ;  $\sqrt{225} = 15$

142. (2)  $49 = 7 \times 7$

$6 \times 6 \times 6 = 216$

Similarly,

$36 = 6 \times 6$

$5 \times 5 \times 5 = 125$

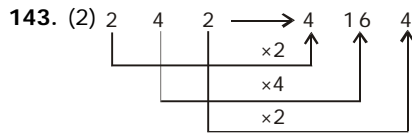

Similarly,

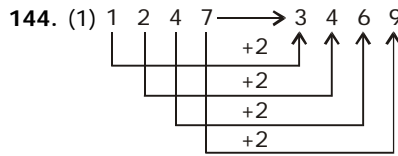
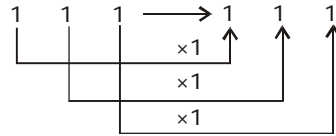

Similarly,

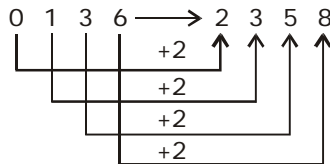

145. (2)  $6 \times 3 - 1 = 17$

Similarly,

$9 \times 3 - 1 = 26$

146. (4)  $9 \times 9 = 81$

Similarly,

$12 \times 12 = 144$

147. (3)  $7 \times 6 + 3 = 42 + 3 = 45$

Similarly,

$5 \times 6 + 3 = 30 + 3 = 33$

148. (1)  $7 \times 4 = 28$ ;  $2 \times 4 = 8$

149. (2)  $49 = (7)^2$

$64 = (7+1)^2$

Similarly,

$144 = (12)^2$

$169 = (12+1)^2$

150. (3)

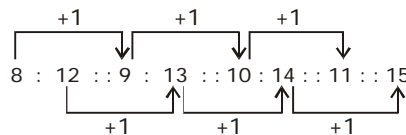

151. (1)  $XXIV \times 2 \Rightarrow 24 \times 2 = 48$

Similarly,

$XIV \times 2 = 14 \times 2 = 28$

152. (1)  $7 \times 7 = 49$

$7 \times 7 \times 7 = 343$

Similarly,

$8 \times 8 = 64$

$8 \times 8 \times 8 = 512$

153. (4)  $24 \times 2.5 = 60$

Similarly,  $210 \times 2.5 = 525$

154. (3)  $6 \times 5 - 1 = 30 - 1 = 29$

Similarly,

$24 \times 5 - 1 = 120 - 1 = 119$

155. (2)  $7 \times 4 + 2 = 28 + 2 = 30$

Similarly,

$17 \times 4 + 2 = 68 + 2 = 70$

156. (2)  $8 \times 9 = 72$ ;  $8 \times 5 = 40$

Similarly,  $6 \times 9 = 54$ ;

$6 \times 5 = 30$

157. (2)  $2 \times 3 = 6$ ;  $3 \times 4 = 12$

$4 \times 5 = 20$ ;  $5 \times 6 = 30$

158. (1)  $5 \times 5 \times 5 + 10$

$= 125 + 10 = 135$

Similarly,

$7 \times 7 \times 7 + 10$

$= 343 + 10 = 353$

159. (3)  $(5)^2 + 5 = 25 + 5 = 30$

Similarly,

$(8)^2 + 5 = 64 + 5 = \boxed{69}$

160. (4)  $3 \times 4 = 12$

$5 \times 6 = 30$

$4 \times 5 = 20$

$6 \times 7 = \boxed{42}$

161. (2)  $(3)^3 + 1 = 27 + 1 = 28$

Similarly,

$(5)^3 + 1 = 125 + 1 = 126$

162. (3)  $2 \times 2 \times 2 - 1 = 8 - 1 = 7$

Similarly,

$3 \times 3 \times 3 - 1 = 27 - 1 = 26$

163. (3)  $2 \times 6 = 12$ ;  $15 \times 6 = 90$

Similarly,  $2 \times 8 = 16$ ;

$15 \times 8 = 120$

164. (3)  $7 \times 7 + 1 = 49 + 1 = 50$

Similarly,

$17 \times 17 + 1 = 289 + 1 = 290$

165. (2)  $(3)^3 = 27$

$(3+2)^3 = 125$

Similarly,

$(4)^3 = 64$

$(4+2)^3 = 216$

166. (2)  $(8)^2 - 2 = 64 - 2 = 62$

Similarly,

$(9)^2 - 2 = 81 - 2 = 79$

167. (2)  $125 = (5)^3$

Similarly,  $64 = (4)^3$

168. (2)  $6 + \left(\frac{6}{3}\right) = 6 + 2 = 8$

Similarly,

$3 + \left(\frac{3}{3}\right) = 3 + 1 = 4$



| ANALOGY OR SIMILARITY |

Similarly,

$$8 \times 9 + 7 = 72 + 7 = 79$$

$$7 \times 9 + 6 = 63 + 6 = 69$$

$$\Rightarrow ? = \frac{79}{69}$$

**200.** (3)  $23 - 10 = 13$

Similarly,

$$54 - 10 = 44$$

**201.** (2)  $17 \times 9 = 153$

$$24 \times 9 = 216$$

**202.** (3)  $3 \times 3 + 2 = 11$

Similarly,

$$7 \times 7 + 2 = 51$$

**203.** (3)  $6 \times \frac{6}{2} = 18$

Similarly,

$$4 \times \frac{4}{2} = 8$$

**204.** (3)  $7 \times 7 + 7$

$$= 49 + 7 = 56$$

Similarly,

$$9 \times 9 + 9$$

$$= 81 + 9 = 90$$

**205.** (4) The relation is  $x : x^2$

$$13 \times 13 = 169$$

Similarly,

$$9 \times 9 = 81$$

**206.** (1) Two consecutive Prime Numbers are given :

$$23 \rightarrow 29$$

Similarly,

$$41 \rightarrow 43$$

**207.** (3)  $2 \times 3 = 6$

$$2 \times 5 = 10$$

Similarly,

$$3 \times 3 = 9$$

$$3 \times 5 = 15$$

**208.** (2)  $7 \times 3 + 3 = 21 + 3 = 24$

Similarly,

$$23 \times 3 + 3 = 69 + 3 = 72$$

**209.** (1)  $6 \times 2 = 12$

$$(6 + 1) \times 20 = 7 \times 20 = 140$$

Similarly,

$$6 \times 26 = 156$$

$$(6 + 1) \times 26 \times 10$$

$$\Rightarrow 7 \times 260 = 1820$$

**210.** (2)  $\sqrt[3]{64} = 4$

Similarly,

$$9 \times 9 \times 9 = 729$$

**211.** (2)

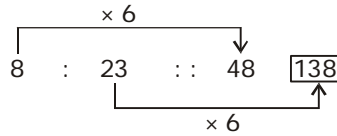

**212.** (4) The relation is  $\Rightarrow x : x^2 + 3$

$$5 \times 5 + 3 = 25 + 3 = 28$$

Similarly,

$$8 \times 8 + 3 = 64 + 3 = 67$$

**213.** (4)  $42 - 22 = 20$

Similarly,

$$64 - 22 = 42$$

**214.** (3) The relationship is :

$$x : (x)^2 \times \frac{x}{2}$$

$$8 \Rightarrow (8)^2 \times \frac{8}{2} = 64 \times 4 = 256$$

Similarly,

$$10 \Rightarrow (10)^2 \times \frac{10}{2} = 100 \times 5 = 500$$

**215.** (2)  $\frac{21}{7} = 3$

Similarly,

$$\frac{574}{7} = 82$$

**216.** (2)  $(7)^2 - 7 = 49 - 7 = 42$

Similarly,

$$(9)^2 - 9 = 81 - 9 = 72$$

**217.** (3)  $\sqrt{121} + 1$

$$\Rightarrow 11 + 1 = 12$$

Similarly,

$$\sqrt{25} + 1$$

$$\Rightarrow 5 + 1 = 6$$

**218.** (1)  $\frac{0.16}{100} = 0.0016$

Similarly,

$$\frac{1.02}{100} = 0.0102$$

**219.** (2)  $\frac{27}{9} = 3$

Similarly,

$$\frac{873}{9} = 97$$

**220.** (4)  $6 \times 6 - 2 = 36 - 2 = 34$

Similarly,

$$9 \times 9 - 2 = 81 - 2 = 79$$

**221.** (2)  $352 : 30$

$$\Rightarrow 3 \times 5 \times 2 = 30$$

$$296 : 108$$

$$\Rightarrow 2 \times 9 \times 6 = 108$$

$$628 : ?$$

$$\Rightarrow 6 \times 2 \times 8 = 96$$

**222.** (1)  $9 \times 3 - 3$

$$= 27 - 3 = 24$$

Similarly,

$$3 \times 3 - 3 = 6$$

**223.** (2)  $(1)^3 = 1 ; (2)^3 = 8$

Similarly,

$$(4)^2 = 16 ; (5)^2 = 25$$

**224.** (2)  $2 \times 2 \times 2 \times 2 \times 2 = (2)^5 = 32$

Similarly,

$$3 \times 3 \times 3 \times 3 \times 3 = (3)^5 = 243$$

**225.** (1)  $16 : 22$

$$\Rightarrow (4)^2 = 16$$

$$\Rightarrow 4 \times 5 + 2 = 22$$

Similarly,

$$36 : ?$$

$$\Rightarrow (6)^2 = 36$$

$$\Rightarrow 6 \times 7 + 2 = 44$$

**226.** (4)  $9 \times 5 + 5 = 50$

Similarly,

$$20 \times 5 + 5 = 105$$

**227.** (2)  $6 \times (6 + 1)$

$$\Rightarrow 6 \times 7 = 42$$

Similarly,

$$7 \times (7 + 1)$$

$$\Rightarrow 7 \times 8 = 56$$

**228.** (4)  $12 \times \frac{12}{2} = 72$

Similarly,

$$8 \times \frac{8}{2} = 32$$

**229.** (1) The relation is :

$$x : x^2 + 1$$

$$4 : (4)^2 + 1$$

$$\Rightarrow 4 : 17$$

Similarly,

$$7 : (7)^2 + 1$$

$$\Rightarrow 7 : 50$$

**230.** (2)  $4 \times 4 \times 4 = 64$

Similarly,

$$2 \times 2 \times 2 = 8$$

**231.** (3)  $7 \times 7 = 49$

$$7 \times 8 = 56$$

Similarly,

$$6 \times 6 = 36$$

$$6 \times 7 = 42$$

**ANALOGY OR SIMILARITY**

232. (1)  $4 \times 4 + 3 = 19$

Similarly,

$7 \times 7 + 3 = 52$

233. (2)  $(2)^3 = 8$

$(3)^4 = 81$

$(4)^3 = 64$

$(5)^4 = 625$

234. (1)  $17 \times 6 = 102$

Similarly,  $23 \times 6 = 138$

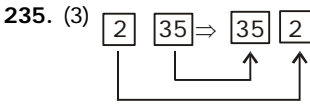

$235 + 352 = 587$

Similarly,

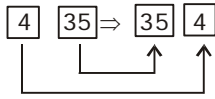

$435 + 354 = 789$

236. (1)  $414 + 222 = 636$

Similarly,

$325 + 222 = 547$

237. (3)  $(14)^2 = 196$

$(14 + 2)^2 = 256$

Similarly,

$(18)^2 = 324$

$(18 + 2)^2 = 400$

238. (1)  $32 : 28$

$\downarrow \qquad \downarrow$   
 $4 \times 8 \qquad 4 \times 7$

Similarly,

$160 : 140$   
 $\downarrow \qquad \downarrow$

$20 \times 8 \qquad 20 \times 7$

239. (3)  $7 \times 7 = 49$

$7 \times 7 \times 7 = 343$

Similarly,

$8 \times 8 = 64$

$8 \times 8 \times 8 = 512$

240. (3)  $7 \times 11 = 77$

Similarly,

$13 \times 11 = 143$

241. (4)  $7 \times 6 = 42$

$8 \times 6 = 48$

242. (1)  $\frac{1}{4} \times \frac{1}{2} = \frac{1}{8}$

Similarly,

$\frac{2}{3} \times \frac{1}{2} = \frac{1}{3}$

243. (4)  $20 \times 2 + 2 = 42$

Similarly,

$31 \times 2 + 2 = 64$

244. (4)  $4 \quad 8 \quad 4 \quad 5$   
 $\downarrow \qquad \qquad \downarrow$   
 $4 \qquad \qquad 5 \Rightarrow (45)^2$

Similarly,

$5 \quad 9 \quad 6 \quad 4$   
 $\downarrow \qquad \qquad \downarrow$   
 $5 \qquad \qquad 4 \Rightarrow (54)^2$

245. (3) A B C D E

1 2 5 9 3

It has been written as :

E C B D A

3 5 2 9 1

$2 \ 9 \ 6 \ 8 \ 4 \Rightarrow 4 \ 6 \ 9 \ 8 \ 2$

Therefore,

A B C D E

7 2 9 3 6

$\Rightarrow$  E C B D A

6 9 2 3 7

246. (3)  $6 : 18$

$\Rightarrow 6 \times \frac{6}{2} = 18$

Similarly,

$4 : ?$

$\Rightarrow 4 \times \frac{4}{2} = 8$

247. (1)  $144 : 13$

$\Rightarrow \sqrt{144} = 12 ; 12 + 1 = 13$

Similarly,

$\sqrt{49} = 7 ; 7 + 1 = 8$

248. (2)  $\frac{21}{7} = 3$

Similarly,

$\frac{574}{7} = 82$

249. (1)  $6 \times 7 = 42$

Similarly,

$5 \times 7 = 35$

250. (2)  $4 \times 4 + 3$

$\Rightarrow 16 + 3 = 19$

Similarly,  $7 \times 7 + 3$

$\Rightarrow 49 + 3 = \boxed{52}$

251. (\*) From first number to second number, the even digit has been halved and the odd digit has been doubled.

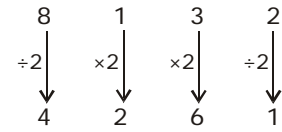
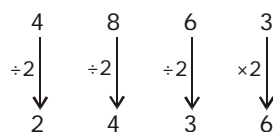

Similarly,

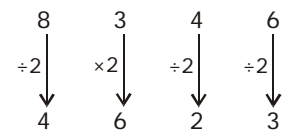
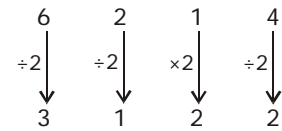

Thus, both the options (1) and (3) are correct.

252. (4)  $5 + 5 + 6 = 16$   
 $1 + 8 + 6 = 15$

Similarly,

$9 + 5 + 1 = 15$

$1 + 7 + 6 = 14$

253. (4)  $(2)^3 = 8$

$(4)^3 = 64$

$(3)^3 = 27$

So,  $(5)^3 = 125$

254. (4)  $4 \times (4 + 1)$

$= 4 \times 5 = 20$

Similarly,

$6 \times (6 + 1)$

$= 6 \times 7 = 42$

255. (3)  $27 = 3 \times 3 \times 3$

$9 = 3 \times 3$

Similarly,

$64 = 4 \times 4 \times 4$

$16 = 4 \times 4$

256. (4)  $42 - 2 = 40$

and,  $\frac{40}{2} = 20$

Similarly,

$64 - 2 = 62$

and,  $\frac{62}{2} = 31$

257. (1)  $\frac{6 \times 6}{2} = 18$

Similarly,

$\frac{4 \times 4}{2} = 8$

258. (1)  $8 = 2 \times 4$

Similarly,

$? = 3 \times 2 = 6$

**ANALOGY OR SIMILARITY**

- 259.** (2)  $14 \times 3 = 42$   
 $14 \times 4 = 56$   
 Similarly,  
 $22 \times 5 = 110$   
 $22 \times 6 = 132$
- 260.** (4)  $381 - 221 = 160$   
 Similarly,  
 $478 - 221 = 257$
- 261.** (4)  $\sqrt{169} - 1 = 12$   
 $\Rightarrow 13 - 1 = 12$   
 Similarly,  
 $\sqrt{25} - 1$   
 $\Rightarrow 5 - 1 = 4$
- 262.** (3)  $(5 + 1)^2 = 36$   
 Similarly,  
 $(7 + 1)^2 = 64$
- 263.** (4)  $(5)^2 = 25$ ;  $25 - 1 = 24$   
 $(4)^2 = 16$ ;  $16 - 1 = 15$   
 Similarly,  
 $(8)^2 = 64$ ;  $64 - 1 = 63$   
 $(7)^2 = 49$ ;  $49 - 1 = \boxed{48}$
- 264.** (2)  $\frac{200}{8} = 25$   
 Similarly,  
 $\frac{300}{8} = 37.50$
- 265.** (2) I  $\Rightarrow$  9, i.e., Position number in the English alphabetical series.  
 Similarly,  
 M  $\Rightarrow$  13
- 266.** (2)  $(01 + 05)^2 = 06 \times 06 = 36$   
 Similarly,  
 $(02 + 05)^2 = 07 \times 07 = 49$
- 267.** (1)  $12 \times 3 + 3 = 39$   
 Similarly,  
 $15 \times 3 + 3 = 48$
- 268.** (4)  $(6)^2 = 36$   
 and,  $(6 + 1)^2 + 1 = 50$   
 Similarly,  
 $(8)^2 = 64$   
 and,  $(8 + 1)^2 + 1 = 82$
- 269.** (2)  $(4)^2 = 16$   
 and,  $(4)^3 = 64$   
 Similarly,  
 $(7)^2 = 49$   
 and,  $(7)^3 = 343$
- 270.** (2)  $11 \times (11 - 1) = 11 \times 10 = 110$   
 Similarly,  
 $15 \times (15 - 1) = 15 \times 14 = 210$

- 271.** (3) 256 is a multiple of 16. Similarly, 104 is a multiple of 13.  
 $16 \times 16 = 256$   
 $13 \times 8 = 104$
- 272.** (1)  $19 \times 30 - 2 = 568$   
 Similarly,  
 $25 \times 30 - 2 = 748$
- 273.** (3)  $(5)^3 - 1 \Rightarrow 125 - 1 = 124$   
 Similarly,  
 $(7)^3 - 1 \Rightarrow 343 - 1 = 342$
- 274.** (2)  $(1)^3 = 1$   
 $(2)^3 = 8$   
 Similarly,  
 $(3)^3 = 27$   
 $(4)^3 = 64$
- 275.** (1)  $7 \times 2 + 5 = 19$   
 Similarly,  
 $10 \times 2 + 5 = 25$
- 276.** (3)  $18 \times 2 - 6 = 36 - 6 = 30$   
 Similarly,  
 $36 \times 2 - 6 = 72 - 6 = 66$
- 277.** (2)  $6 \times 4 = 24$   
 $6 \times 10 = 60$   
 Similarly,  
 $6 \times 35 = 210$   
 $6 \times 56 = 336$   
 All the numbers are multiples of 6.
- 278.** (4)  $6 \times 7 = 42$   
 $12 \times 7 = 84$
- 279.** (2)
- 1 4 7  $\rightarrow$  7 4 1
- Similarly,
- 8 6 9  $\rightarrow$  9 6 8
- 280.** (2)  $(5)^2 \times 4 = 25 \times 4 = 100$   
 Similarly,  
 $(7)^2 \times 4 = 49 \times 4 = 196$
- 281.** (3)  $7 \times 4 + 4 = 28 + 4 = 32$   
 Similarly,  
 $28 \times 4 + 4 = 112 + 4 = 116$

- 282.** (1)  $2 : 10 \Rightarrow 2 + 8 = 10$   
 Similarly,  
 $26 \Rightarrow 2, 6 = 2 \times 3$   
 Therefore,  $26 + 8 \times 3 = 26 + 24 = 50$
- 283.** (2)  $583 \Rightarrow 5 + 8 + 3 = 16$   
 $295 \Rightarrow 2 + 9 + 5 = 16$   
 Similarly,  
 $486 \Rightarrow 4 + 8 + 6 = 18$   
 $378 \Rightarrow 3 + 7 + 8 = 18$
- 284.** (2)  $121 = (12 - 1)^2 = 11 \times 11$   
 Similarly,  
 $25 = (6 - 1)^2 = 5 \times 5$
- 285.** (3)  $27 = 3 \times 3 \times 3$   
 $125 = 5 \times 5 \times 5$   
 Similarly,  
 $64 = 4 \times 4 \times 4$   
 $\therefore ? = 6 \times 6 \times 6 = 216$
- 286.** (1)  $100 = 10 \times 10 = 10^2$   
 Similarly,  
 $100000 = 10 \times 10 \times 10 \times 10 \times 10 = 10^5$
- 287.** (2)  $\frac{20}{2} + 1 = 10 + 1 = 11$   
 Similarly,  
 $\frac{102}{2} + 1 = 51 + 1 = 52$
- 288.** (4)  $(5)^2 + 1 = 26$   
 $(7)^2 - 1 = 48$   
 $(9)^2 + 1 = 82$   
 Therefore,  $(11)^2 - 1 = 120$
- 289.** (3)  $6 : 5$   
 $\downarrow \quad \downarrow$   
 $3 \times 2 \quad 3 + 2$   
 Similarly,  
 $8 \rightarrow 4 \times 2$   
 $4 + 2 = 6$
- 290.** (3)  $37 \times 2 - 9 = 74 - 9 = 65$   
 Similarly,  
 $50 \times 2 - 18 = 100 - 18 = 82$
- 291.** (4)  $68 + 62 = 130$   
 $130 + (62 + 30) = 222$   
 $222 + (92 + 36) = 350$
- 292.** (3)  $12 : 144$   
 $(12)^1 : (12)^2$   
 Similarly,  
 $(20)^1 : (20)^2$   
 $20 : 400$
- 293.** (2)  $4 + 5 + 6 = 15$   
 Similarly,  
 $7 + 8 + 9 = 24$

**ANALOGY OR SIMILARITY**

294. (3)  $4 : 20$   
 $\Rightarrow 4 \times (4 + 1)$   
 $\Rightarrow 4 \times 5 = 20$

Similarly,  
 $8 \times (8 + 1)$   
 $\Rightarrow 8 \times 9 = 72$

295. (3)  $9 \times 9 \times 2 = 162$   
 Similarly,  
 $8 \times 8 \times 2 = 128$

296. (3)  $841 = 29 \times 29$   
 Similarly,  $289 = 17 \times 17$

297. (4)  $9 = (3)^2$   
 $25 = (5)^2$   
 $49 = (7)^2$   
 $\therefore ? = (7 + 2)^2 = 81$

298. (2)  $\frac{85-1}{2} = 42$

Similarly,  
 $\frac{139-1}{2} = 69$

299. (3)  $8 \times 4 = 32$   
 $\therefore ? = \frac{108}{4} = 27$

300. (3)  $12 + 8 = 20$   
 $20 + 10 = 30$   
 $30 + 12 = 42$

301. (4)  $12 \times 5 - 6 = 60 - 6 = 54$   
 Similarly,  
 $15 \times 5 - 6 = 75 - 6 = \boxed{69}$

302. (2)  $\frac{21}{7} = 3$   
 Similarly,  
 $\frac{574}{7} = 82$

303. (4)  $3 \times 3 \times 3 \times 3 \times 3 = 3^5 = 243$   
 Similarly,  
 $5 \times 5 \times 5 \times 5 \times 5 = 5^5 = 3125$

304. (4)  $5 \times (5 + 1) = 30$   
 Similarly,  
 $7 \times (7 + 1) = 56$

305. (1)  $(15)^2 = 225$   
 Similarly,  
 $(12)^2 = 144$

306. (2)  $4 \times (4 - 1) = 12$   
 Similarly,  
 $5 \times (5 - 1) = 20$

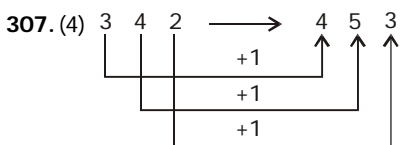

Similarly,

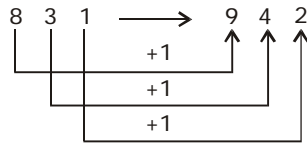

308. (1)  $\frac{42-2}{2} = \frac{40}{2} = 20$

Similarly,  
 $\frac{64-2}{2} = \frac{62}{2} = 31$

309. (2)  $27 : 125$   
 $(3)^3 : (5)^3$

Similarly,  
 $64 : 216$   
 $(4)^3 : (6)^3$

310. (4)  $13 \times 2 - 6 = 20$   
 Similarly,  
 $17 \times 2 - 6 = 28$

311. (3)  $8 \times 8 + 8 = 72$   
 $9 \times 9 + 9 = 90$

Similarly,  
 $12 \times 12 + 12 = 156$   
 $13 \times 13 + 13 = 182$

312. (2)  $8 \times \frac{8}{2} = 32$

Similarly,  
 $6 \times \frac{6}{2} = 18$

313. (1)  $54 : 90$   
 $\Rightarrow 5 + 4 = 9 + 0$   
 Similarly,  
 $134 \Rightarrow 1 + 3 + 4 = 8$   
 $206 \Rightarrow 2 + 0 + 6 = 8$

314. (3)  $5 \ 3 \ 4$   
 $\frac{+1 \ 1 \ 1}{6 \ 4 \ 5}$

Similarly,  
 $3 \ 8 \ 1$

$\frac{+1 \ 1 \ 1}{4 \ 9 \ 2}$

315. (4)  $12 \times 6 = 72$   
 $13 \times 6 = 78$

316. (4)  $9 = 3 \times 3$   
 $8 = 2 \times 2 \times 2$   
 Similarly,  
 $16 = 4 \times 4$   
 $27 = 3 \times 3 \times 3$

**TYPE -IV**

1. (1)  $1 \quad 2 \quad 3 \quad 4$   
 $3 \quad 2 \quad 1 \quad 4$

T A L E  $\Rightarrow$  L A T E

The first and the third letters have been interchanged.

Therefore,  
 $3 \ 2 \ 1 \ 4 \quad 1 \ 2 \ 3 \ 4$   
 C A F E  $\Rightarrow$  F A C E

2. (1) A  $\xrightarrow{+3}$  D  $\xrightarrow{+4}$  H  $\xrightarrow{+5}$  M

Z  $\xrightarrow{-3}$  W  $\xrightarrow{-4}$  S  $\xrightarrow{-5}$  N

Similarly,

C  $\xrightarrow{+3}$  F  $\xrightarrow{+4}$  J  $\xrightarrow{+5}$  O

Y  $\xrightarrow{-3}$  V  $\xrightarrow{-4}$  R  $\xrightarrow{-5}$  M

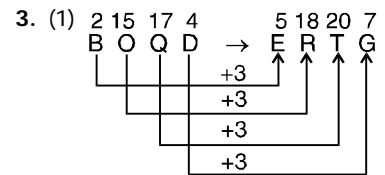

Similarly,

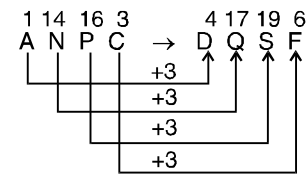

4. (4) The given pair is of opposite letters.

**Series of opposite letters**

A	B	C	D	E	F	G	H	I	J	K	L	M
↓	↓	↓	↓	↓	↓	↓	↓	↓	↓	↓	↓	↓
Z	Y	X	W	V	U	T	S	R	Q	P	O	N

Now

A F K P

↓ ↓ ↓ ↓

Z U P K

Similarly,

B G L Q

↓ ↓ ↓ ↓

Y T O J

5. (3) The two terms are the sets of opposite letters.

B V S C

↓ ↓ ↓ ↓

Y E H X

Similarly,

M R C P

↓ ↓ ↓ ↓

N I X K

**ANALOGY OR SIMILARITY**

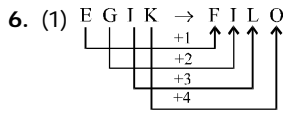

Similarly,

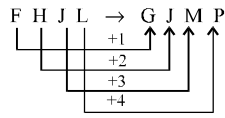

7. (4)

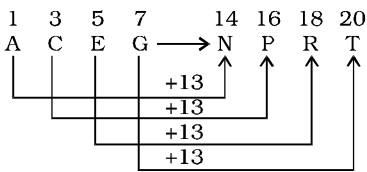

Similarly,

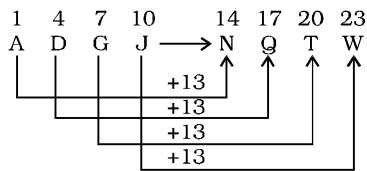

8. (1)

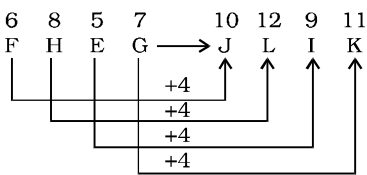

Similarly,

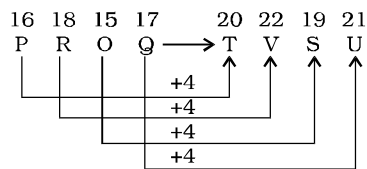

9. (3) A ↔ Z

Pairs of opposite Letter

B ↔ Y

Similarly,

H ↔ S

I ↔ R

And, K ↔ P

L ↔ O

10. (4)

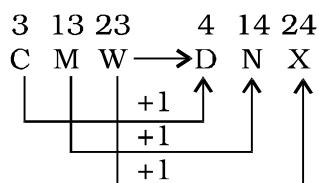

Similarly,

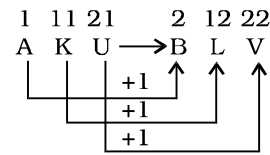

11. (1)

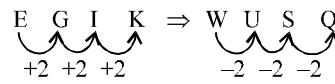

Similarly,

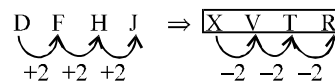

12. (1)

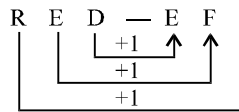

Similarly,

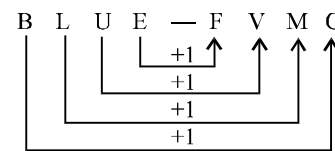

13. (4) P A R T S → S T R A P

Similarly,

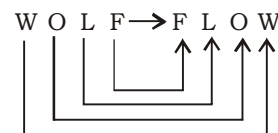

14. (4) A D B C → W Z X Y

Pair of opposite letters.

Similarly,

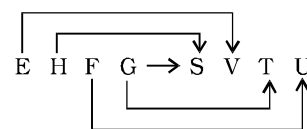

15. (3)

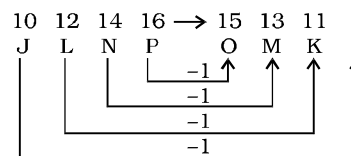

Similarly,

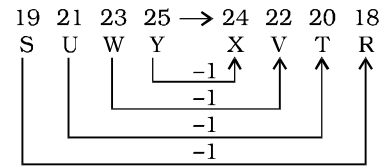

16. (3)

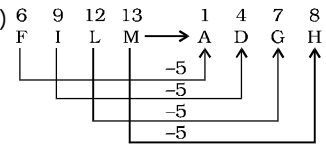

Similarly,

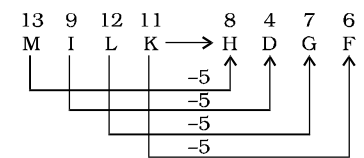

17. (1) EGQU, ⇒

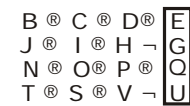

18. (4)

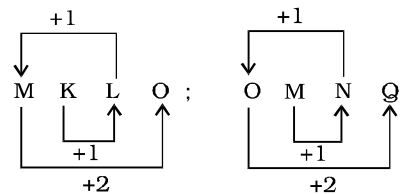
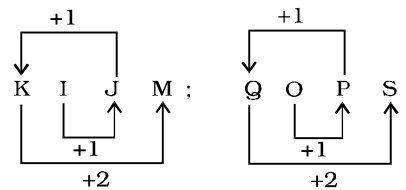

19. (4)  $1\ 3\ 5\ 7\ 9\ 11\ 13\ 15$

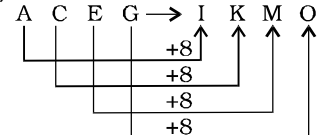

Similarly,

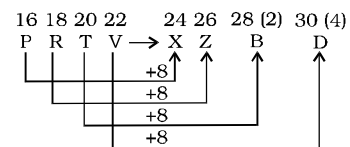

**ANALOGY OR SIMILARITY**

20. (3)

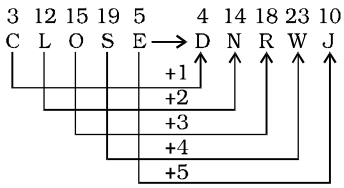

Similarly,

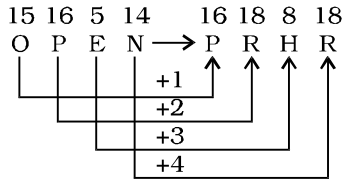

21. (1)

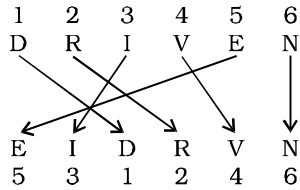

Similarly,

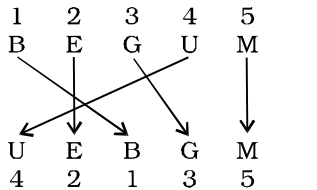

22. (2)

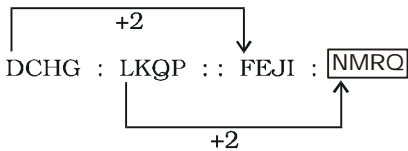

23. (4)

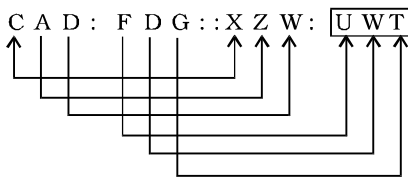

Pairs of opposite letters.

24. (3) Two adjacent letters are interchanged.

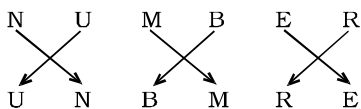

Similarly,

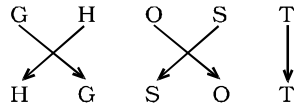

25. (4)

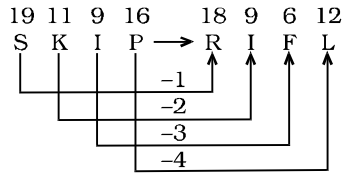

Similarly,

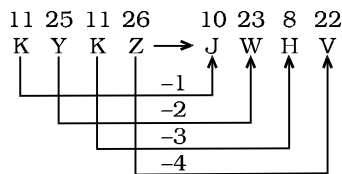

26. (2)

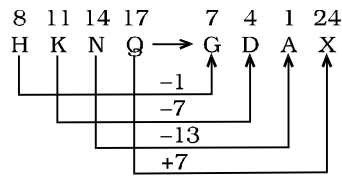

Similarly,

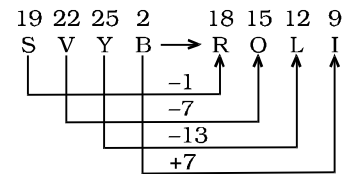

27. (2)

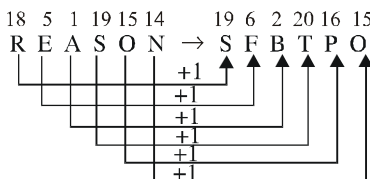

Similarly,

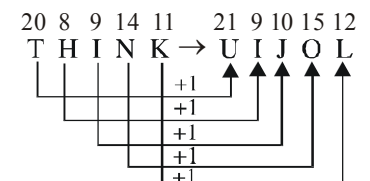

28. (3)

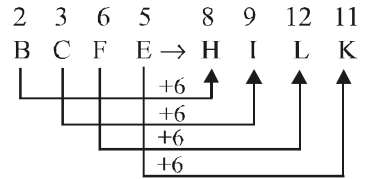

Similarly,

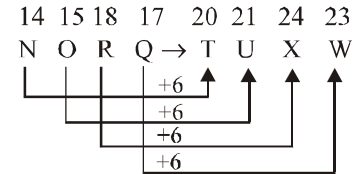

29. (1) Pair of opposite letters are given consecutively.

30. (3)

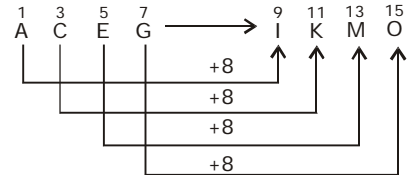

Similarly,

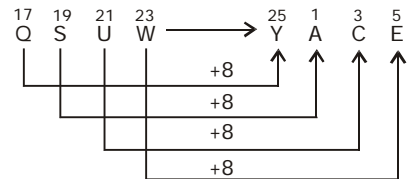

31. (3)

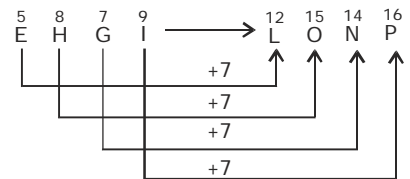

Therefore,

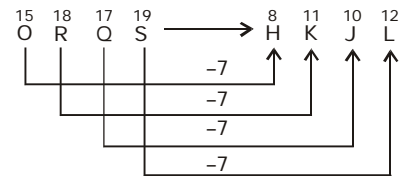

32. (3) Pairs of opposite letters are given :

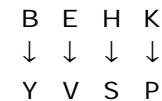

**ANALOGY OR SIMILARITY**

Similarly,

C F I L  
 ↓ ↓ ↓ ↓  
 X U R O

33. (3) A D H M  
 ↓ ↓ ↓ ↓  
 Z W S N

Pairs of opposite letters  
 Similarly,

C F J O  
 ↓ ↓ ↓ ↓  
 X U Q L

34. (4) The pairs of opposite letters  
 are given :

A C F J  
 ↓ ↓ ↓ ↓  
 Z X U Q

Similarly,

E G J N  
 ↓ ↓ ↓ ↓  
 V T Q M

35. (1)

M A S T E R → O C U V G T  
 ↓ ↓ ↓ ↓ ↓ ↓  
 +2 +2 +2 +2 +2 +2

Similarly,

L A B O U R → N C D Q W T  
 ↓ ↓ ↓ ↓ ↓ ↓  
 +2 +2 +2 +2 +2 +2

36. (1) A B C D → W X Y Z  
 ↓ ↓ ↓ ↓  
 +1 +1 +1 +1

Pairs of opposite letters are given  
 in the reverse order.

Therefore,

E F G H → S T U V  
 ↓ ↓ ↓ ↓  
 +1 +1 +1 +1

37. (1) W R I T E  
 ↓ ↓ ↓ ↓ ↓  
 J E V G R  
 Therefore,  
 W R O N G  
 ↓ ↓ ↓ ↓ ↓  
 J E B A T

The code for R → E

The code for T → G

[R → +2 → T, E → +2 → G]

N and O are consecutive letters.  
 Therefore, their coded form also  
 be consecutive letters.

38. (4) The pairs of opposite letters  
 are given.

E J O T  
 ↓ ↓ ↓ ↓  
 V Q L G

Therefore,

B G L Q  
 ↓ ↓ ↓ ↓  
 Y T O J

39. (1) The pairs of opposite letters  
 are given.

D E A D  
 ↓ ↓ ↓ ↓  
 W V Z W

Therefore,

F G C F  
 ↓ ↓ ↓ ↓  
 U T X U

40. (4)

P C W L R E X M  
 ↓ ↓ ↓ ↓ ↓ ↓  
 +2 +2 +1 +1 +2 +2

Similarly,

T H N Y V J O Z  
 ↓ ↓ ↓ ↓ ↓ ↓  
 +2 +2 +1 +1 +2 +2

41. (3)

17 16 18 19 20 21 23 22  
 Q P R S → T U W V  
 ↓ ↓ ↓ ↓ ↓ ↓  
 +3 +5 +5 +3

Similarly,

J I K L → M N P O  
 ↓ ↓ ↓ ↓ ↓ ↓  
 +3 +5 +5 +3

42. (1)

1 3 3 5 → 5 7 7 9  
 A C C E → E G G I  
 ↓ ↓ ↓ ↓  
 +4 +4 +4 +4

Similarly,

9 11 11 13 → 13 15 15 17  
 I K K M → M O O Q  
 ↓ ↓ ↓ ↓  
 +4 +4 +4 +4

43. (4)

19 18 16 17 → 15 14 12 13  
 S R P Q → O N L M  
 ↓ ↓ ↓ ↓  
 -4 -4 -4 -4

Similarly,

11 10 8 9 → 7 6 4 5  
 K J H I → G F D E  
 ↓ ↓ ↓ ↓  
 -4 -4 -4 -4

44. (4)

I K K L → J L L M  
 ↓ ↓ ↓ ↓  
 +1 +1 +1 +1

Similarly,

S U U V → T V V W  
 ↓ ↓ ↓ ↓  
 +1 +1 +1 +1

45. (4) F I G U R  
 ↓ ↓ ↓ ↓  
 F G I R U

Similarly,

S T R E S  
 ↓ ↓ ↓ ↓  
 S R T S E

46. (2)

I J L → M N P  
 ↓ ↓ ↓ ↓  
 +4 +4 +4

**ANALOGY OR SIMILARITY**

Similarly,

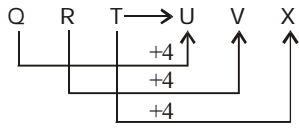

47. (1)

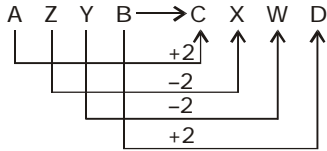

Similarly,

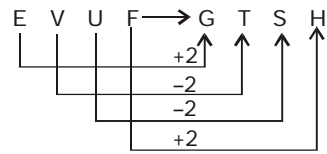

48. (2) MAT -> NCW

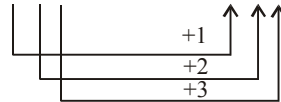

Similarly,

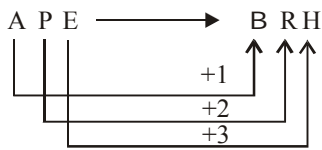

49. (1) A D B C  
W Z X Y

Pairs of opposite letters

E H F G  
S V T U

50. (2)

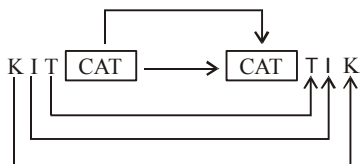

Similarly,

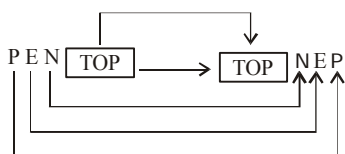

51. (1) L J H -> K K I

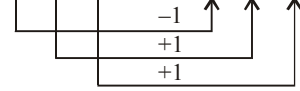

Similarly,

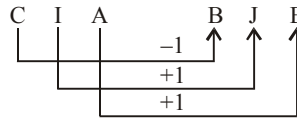

52. (4) E G I K -> F I L O

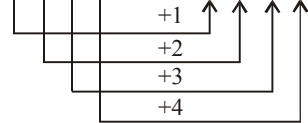

Similarly,

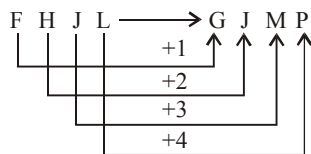

53. (2)

1 2 3 4 5      5 3 1 2 4  
D R I V E -> E I D R V

Similarly

1 2 3 4 5      5 3 1 2 4  
B E G U M -> M G B E U

54. (1)

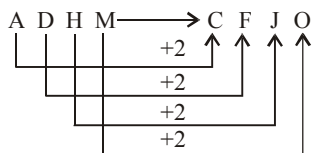

Similarly,

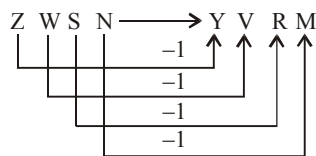

55. (1)

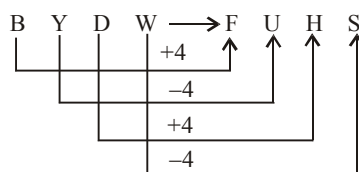

Similarly,

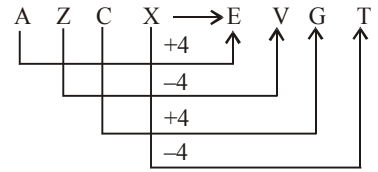

56. (3)

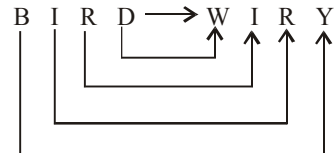

Pairs of Opposite Letters

Similarly,

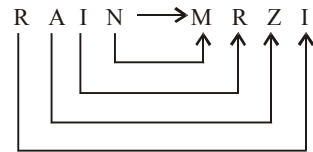

57. (1)

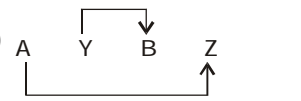

Pairs of Opposite Letters

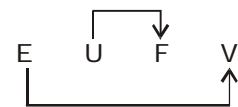
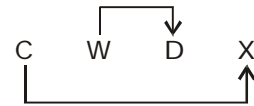

Similarly,

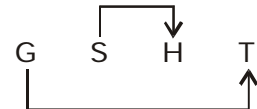

58. (4) D -1 -> C +2 -> E +1 -> F  
Q -1 -> P +2 -> R +1 -> S  
X -1 -> W +2 -> Y +1 -> Z  
N -1 -> M +2 -> O +1 -> P

59. (3)

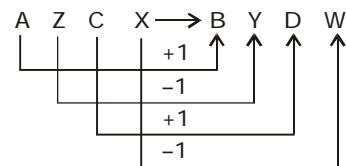

**ANALOGY OR SIMILARITY**

Similarly,

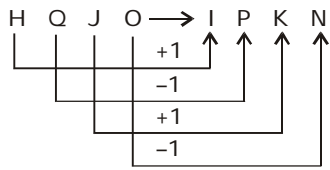

60. (2)

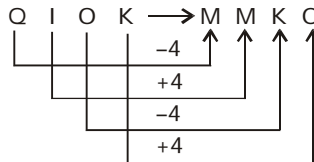

Similarly,

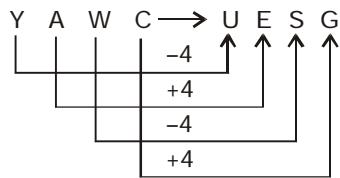

61. (1)

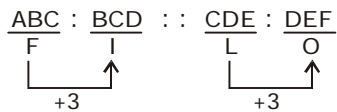

62. (2) The word has been divided into two equal parts. Then, the letters have been written in reverse order in each part.

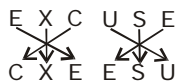

Similarly,



63. (2)

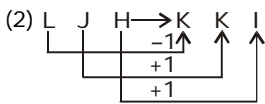

Similarly,

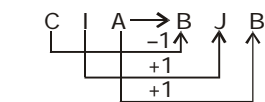

64. (3) The pairs of opposite letters have been given :

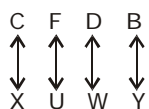

Similarly,

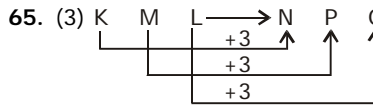
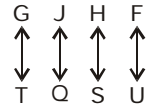

Similarly,

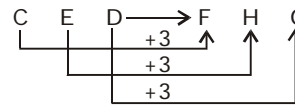

66. (1)

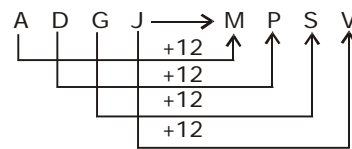

Therefore,

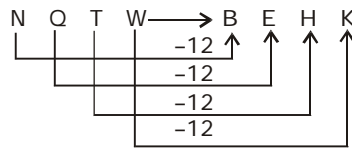

67. (4)

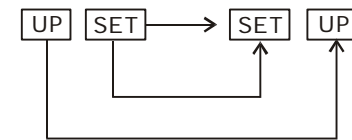

Similarly,

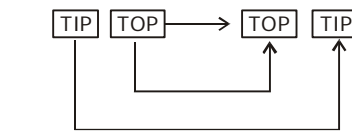

68. (3)

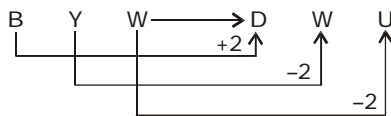

Similarly,

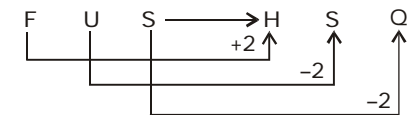

69. (3)

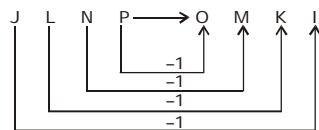

Similarly,

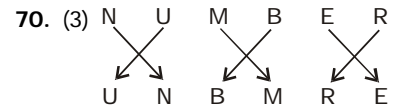
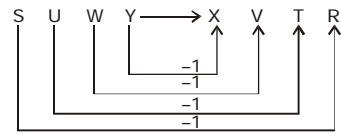

Similarly,

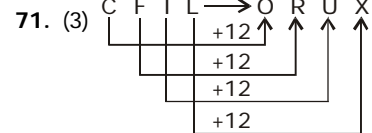
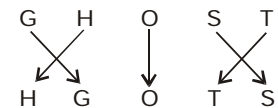

Similarly,

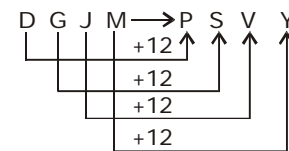

72. (3) B E H K  
 ↓ ↓ ↓ ↓  
 Y V S P  
 Pairs of opposite Letters  
 Similarly,

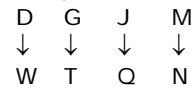

73. (4)

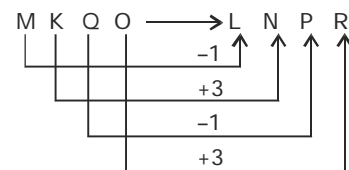

Similarly,

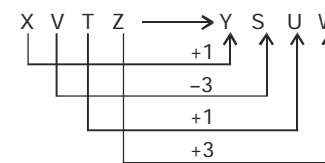

74. (2) The letters have been written in reverse order.  
 TEKCAR ⇒ RACKET  
 Similarly,  
 TCEJBO ⇒ OBJECT

**ANALOGY OR SIMILARITY**

75. (4) First three letters are consecutive letters but in reverse order and the fourth letter comes immediately after the first letter in the English alphabetical series.

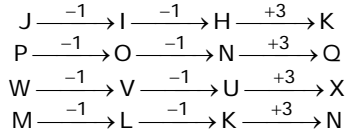

76. (4)

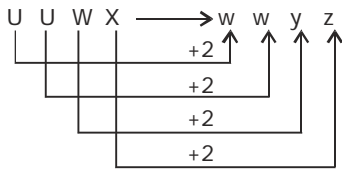

Similarly,

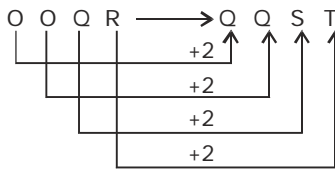

77. (1)

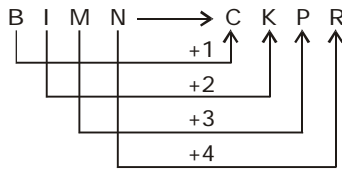

Similarly,

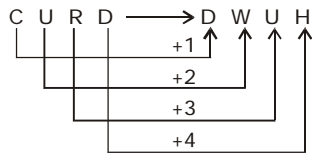

78. (3)

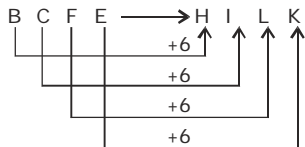

Similarly,

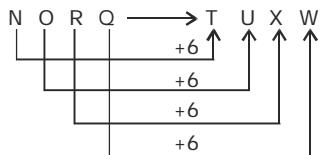

79. (4) 1 2 3 4 5 6 7  
N U M E R A L

It has been arranged as

2 4 6 7 5 3 1  
U E A L R M N

Therefore,

1 2 3 4 5 6 7  
A L G E B R A

2 4 6 7 5 3 1  
L E R A B G A

80. (4)

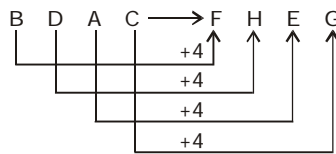

Similarly,

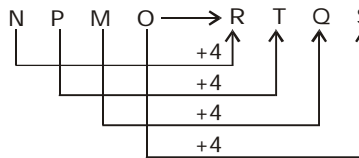

81. (2)

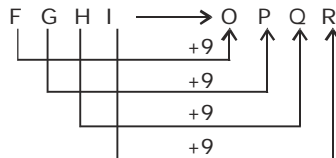

Similarly,

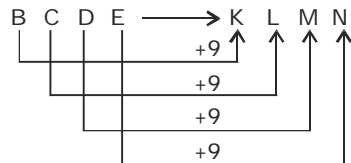

82. (1)

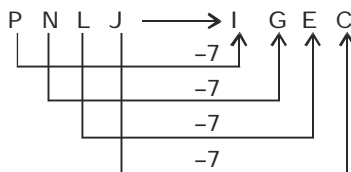

Similarly,

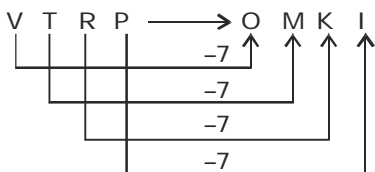

83. (2)

L ⇒ KM; L  $\xrightarrow{-1}$  K; L  $\xrightarrow{+1}$  M

O ⇒ NP; O  $\xrightarrow{-1}$  N; O  $\xrightarrow{+1}$  P

C ⇒ BD; C  $\xrightarrow{-1}$  B; C  $\xrightarrow{+1}$  D

K ⇒ JL; K  $\xrightarrow{-1}$  J; K  $\xrightarrow{+1}$  L

E ⇒ DF; E  $\xrightarrow{-1}$  D; E  $\xrightarrow{+1}$  F

R ⇒ QS; R  $\xrightarrow{-1}$  Q; R  $\xrightarrow{+1}$  S

Similarly,

L ⇒ KM

E ⇒ DF

F ⇒ F  $\xrightarrow{-1}$  E; F  $\xrightarrow{+1}$  G

T ⇒ T  $\xrightarrow{-1}$  S; T  $\xrightarrow{+1}$  U

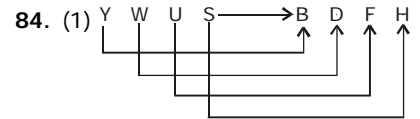

Pairs of Opposite Letters

Similarly,

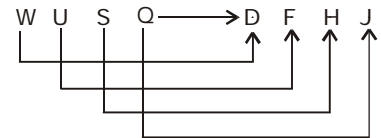

85. (1) A  $\xrightarrow{+3}$  D  $\xrightarrow{-1}$  C  $\xrightarrow{-1}$  B

K  $\xrightarrow{+3}$  N  $\xrightarrow{-1}$  M  $\xrightarrow{-1}$  L

Similarly,

A  $\xrightarrow{+3}$  D  $\xrightarrow{-1}$  B  $\xrightarrow{-1}$  F

D  $\xrightarrow{+3}$  G  $\xrightarrow{-1}$  F  $\xrightarrow{-1}$  E

86. (3)

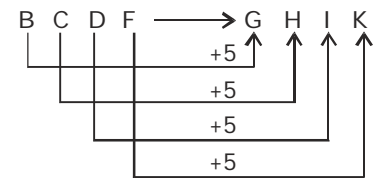

Similarly,

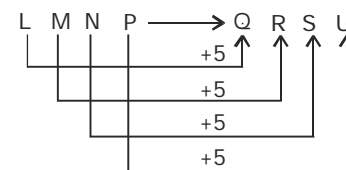

**ANALOGY OR SIMILARITY**

87. (1)

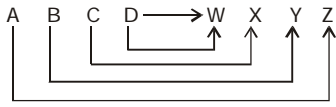

Pairs of Opposite Letters.  
Similarly,

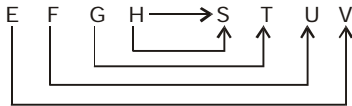

88. (4)

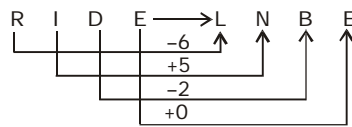

Similarly,

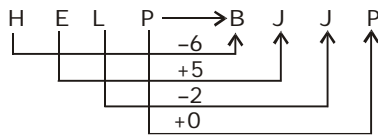

89. (4)

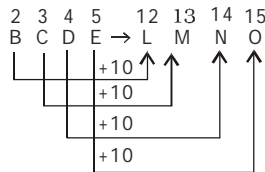

Similarly,

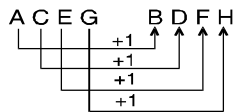
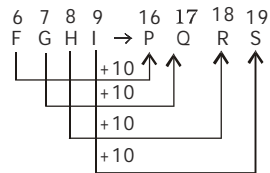

Similarly,

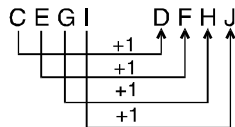

90. (2)  $\boxed{E} \boxed{a} \boxed{r} \boxed{n} \Rightarrow \boxed{n} \boxed{e} \boxed{a} \boxed{r}$

Similarly,

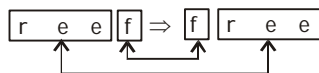

91. (1)

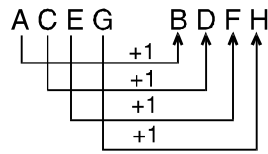

Similarly,

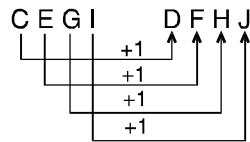

92. (3) In the code the two adjacent letters have been interchanged. Thus,

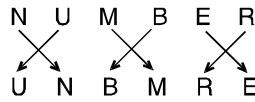

Similarly,

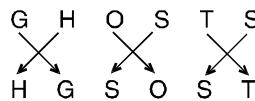

93. (3)

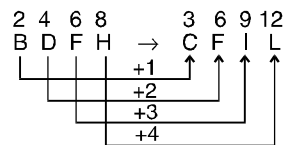

Similarly,

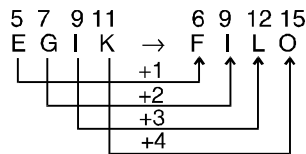

94. (3)

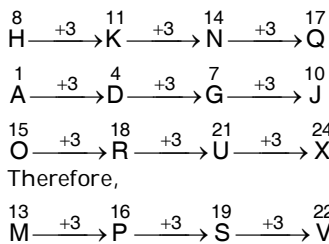

95. (4)

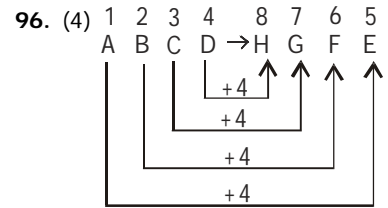
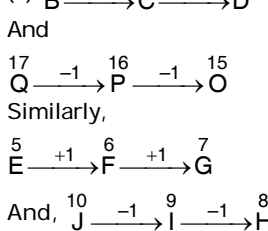

Similarly,

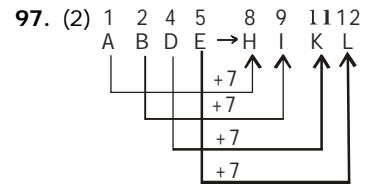
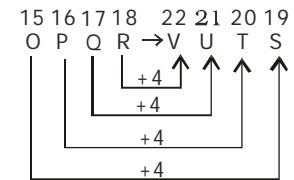

Similarly,

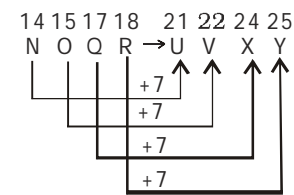

98. (2)

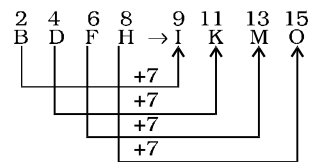

Similarly,

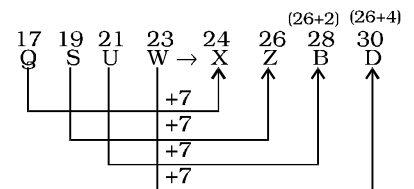

99. (1)

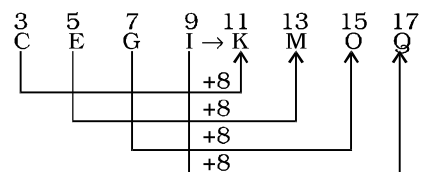

**ANALOGY OR SIMILARITY**

Similarly,

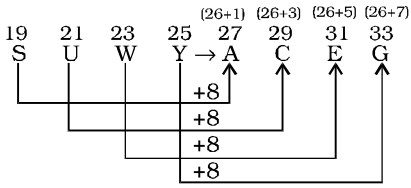

100. (4)

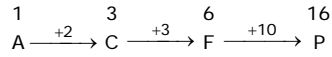

And,

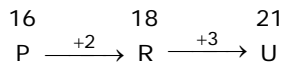

Similarly,

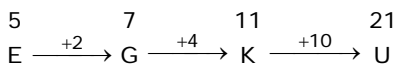

And,

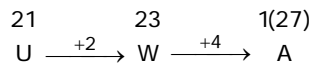

101. (1)

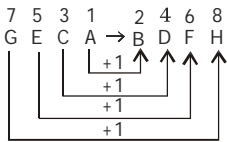

Similarly,

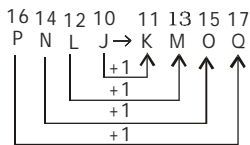

102. (4)

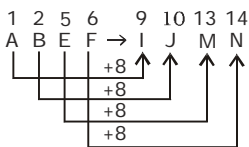

Similarly,

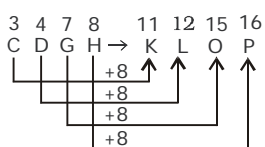

103. (4)

1 2 3 4  
a c m e  
It has been written as :  
3 1 2 4  
m a c e  
Similarly,  
1 2 3 4  
a l g a  
It should be written as :  
3 1 2 4  
g a l a

104. (2)

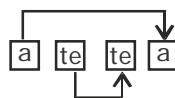

Similarly,

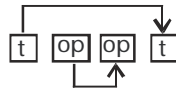

105. (3)

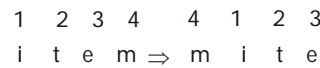

Similarly,

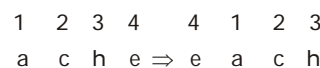

106. (4)

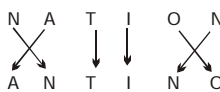

Similarly



107. (1)

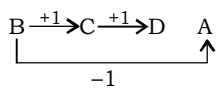

And,

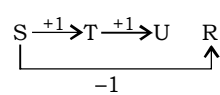

Similarly,

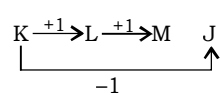

And,

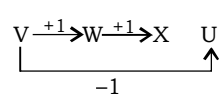

108. (4)

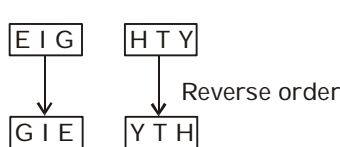

Similarly,

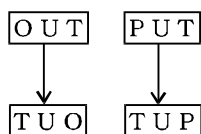

109. (3) R +3 -> U +3 -> X :

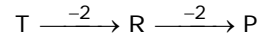

Similarly,

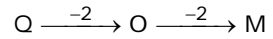
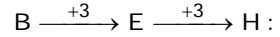

110. (4) XYZ -> CAB (Opposite Letters)

Similarly

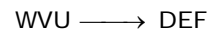

111. (2) 17 16 15 14 13 12 11 10

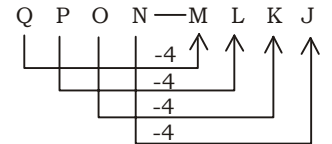

Similarly,

24 23 22 21 20 19 18 17

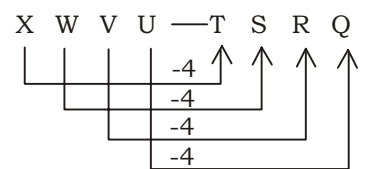

112. (1)

14 15 16 17 13 12 11 10

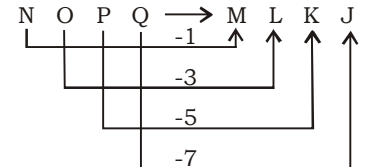

Similarly,

8 9 10 11 7 6 5 4

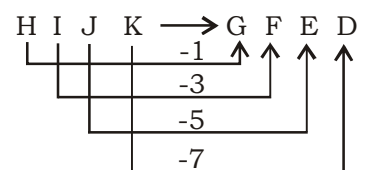

113. (1) B at -> C at



Similarly,

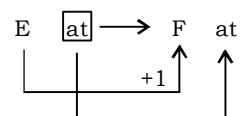

**ANALOGY OR SIMILARITY**

114. (4) In the words **DumB** and **BonD** the first and the last letters are capital letters while the two middle letters are small letters. Similarly, in the words **RusT** and **WorK**, the first and the last letters are Capital letters and the two middle letters are small letters.

115. (1)  $12 \xrightarrow{+2} 14 \xrightarrow{+2} 16 \xrightarrow{+2} 18$   
 $L \rightarrow N \rightarrow P \rightarrow R$   
 $20 \xrightarrow{+1} 21 \xrightarrow{+3} 24 \xrightarrow{+2} 2$   
 $T \rightarrow U \rightarrow X \rightarrow Z$

The letters are in increasing order.

Similarly,

$14 \xrightarrow{+2} 16 \xrightarrow{+2} 18 \xrightarrow{+2} 20$   
 $N \rightarrow P \rightarrow R \rightarrow T$   
 $6 \xrightarrow{+2} 8 \xrightarrow{+2} 10 \xrightarrow{+2} 12$   
 $F \rightarrow H \rightarrow J \rightarrow L$

116. (2)

1 2 3 4 5 → 5 4 3 2 1  
 D E V I L → L I V E D

(Reverse order) →  
 Therefore,  
 STRAP → PARTS

117. (4)  $H O U S E \rightarrow G N T R D$

Therefore,

$K H F G S \rightarrow L I G H T$

118. (3)

M E T A P H O R  
 E M A T H P R O

Similarly,

N O R M A L  
 O N M R L A

119. (2) The letters have been written in reverse order.

120. (2) The pairs of opposite letters are given.

G R A I N  
 ↓ ↓ ↓ ↓ ↓  
 T I Z R M

Similarly,

B R A I N  
 ↓ ↓ ↓ ↓ ↓  
 Y I Z R M

121. (2) Two letters, one preceding and second following, are given for each letter.

$C \xrightarrow{-1} B$  and  $C \xrightarrow{+1} D$   
 $U \xrightarrow{-1} T$  and  $U \xrightarrow{+1} V$   
 $T \xrightarrow{-1} S$  and  $T \xrightarrow{+1} U$

Similarly,

$T \xrightarrow{-1} S$  and  $T \xrightarrow{+1} U$   
 $I \xrightarrow{-1} H$  and  $I \xrightarrow{+1} J$   
 $P \xrightarrow{-1} O$  and  $P \xrightarrow{+1} Q$

122. (4)  $A \xrightarrow{+2} C$

$C \xrightarrow{+3} F$

Similarly,

$M \xrightarrow{+2} O$

$O \xrightarrow{+3} R$

123. (2)  $B C D \rightarrow G F E$

Similarly,

$H I J \rightarrow M L K$

124. (3)  $Q P R S \rightarrow T U W V$

Similarly,

$J I K L \rightarrow M N P O$

125. (1)  $A Z B Y \rightarrow C X D W$

Similarly,

$H S I R \rightarrow J Q K P$

126. (2)  $H Q Z I \rightarrow J S B K$

Similarly,

$D M V E \rightarrow F O X G$

127. (3)  $A \xrightarrow{+1} B$

$N \xrightarrow{+1} O$

Similarly,

$L \xrightarrow{+1} M$

$Y \xrightarrow{+1} Z$

128. (2)  $A C E \rightarrow H I L$

Similarly,

$M O Q \rightarrow T U X$

129. (3)

$E D F H \rightarrow J L N P$

Similarly,

$R T V X \rightarrow Z B D F$

130. (1)  $14 \xrightarrow{-2} 12 \xrightarrow{+3} 15$   
 $N \rightarrow L \rightarrow O$   
 $18 \xrightarrow{-2} 16 \xrightarrow{+3} 19$   
 $R \rightarrow P \rightarrow S$   
 $22 \xrightarrow{-2} 20 \xrightarrow{+3} 23$   
 $V \rightarrow T \rightarrow W$

**ANALOGY OR SIMILARITY**

Similarly,

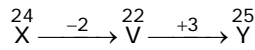

131. (4)

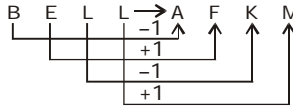

Similarly,

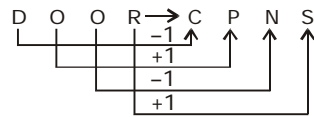

132. (3)

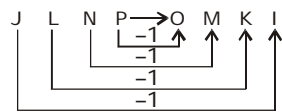

Similarly,

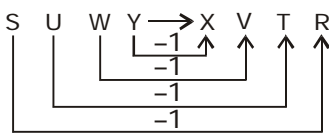

133. (3)  $V \xrightarrow{+2} X \xrightarrow{+2} Z$

$J \xrightarrow{+2} L \xrightarrow{+2} N$

$G \xrightarrow{+2} I \xrightarrow{+2} K$

Therefore,

$O \xrightarrow{+2} Q \xrightarrow{+2} S$

134. (4)

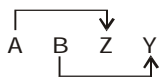

Pairs of Opposite Letters

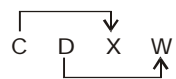

Therefore,



135. (3)

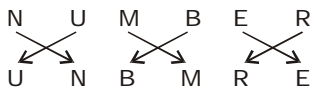

Similarly,

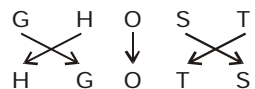

136. (4)

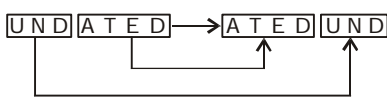

Similarly,

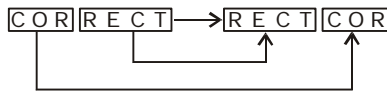

137. (1)

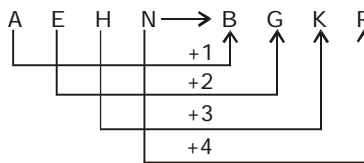

Similarly,

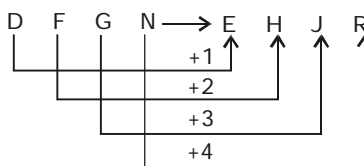

138. (2)

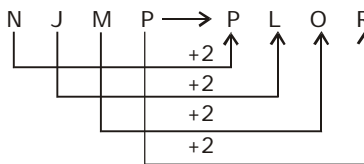

Similarly,

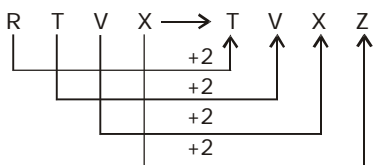

139. (3) The letters have been written in reverse order.

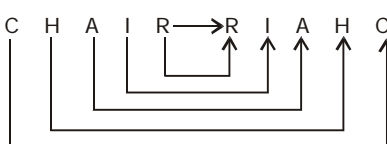

Similarly,

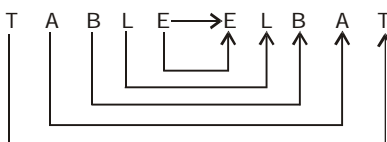

140. (4)

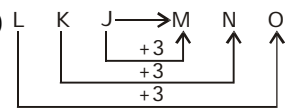

Similarly,

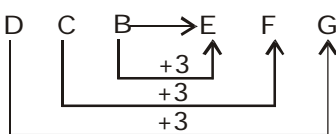

141. (1)

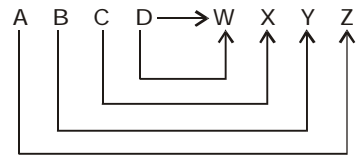

Pairs of Opposite letters.

Similarly,

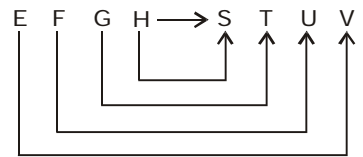

142. (4)

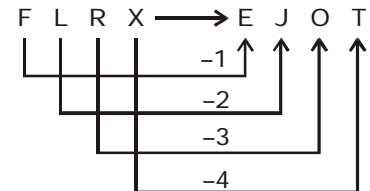

Similarly,

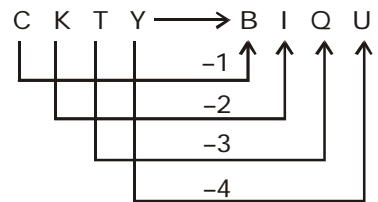

143. (3)

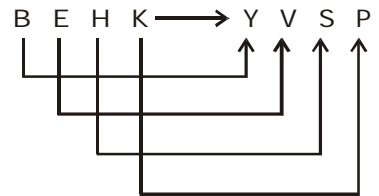

Pairs of Opposite letters.

Similarly,

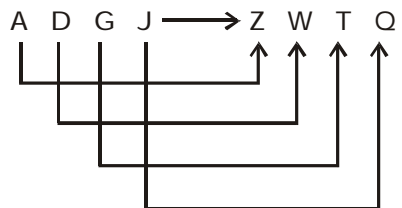

**ANALOGY OR SIMILARITY**

144. (3)

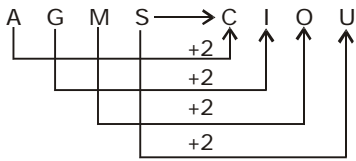

Similarly,

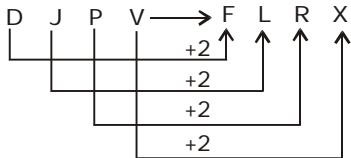

145. (1)

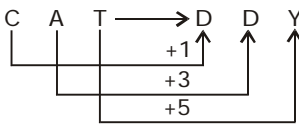

Similarly,

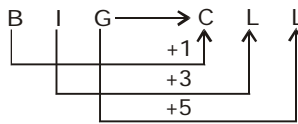

146. (2)

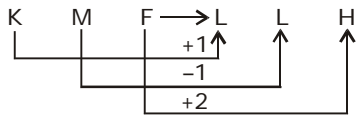

Similarly,

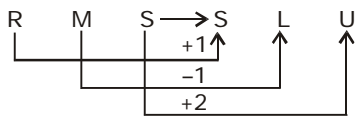

147. (2)

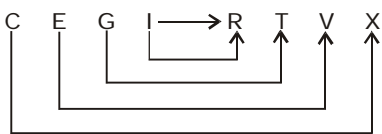

Pair of Opposite Letters

Similarly,

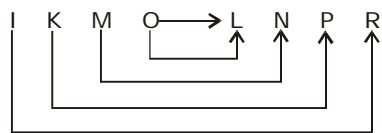

148. (2)

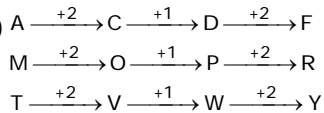

Similarly,

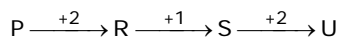

149. (2)

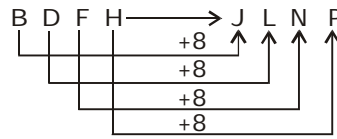

Similarly,

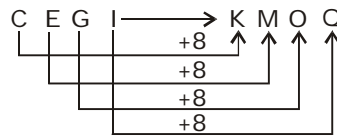

150. (3)

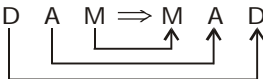

Similarly,

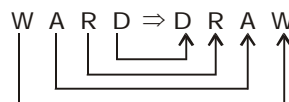

151. (4)

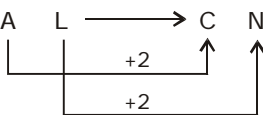

Similarly,

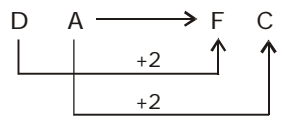

152. (1)

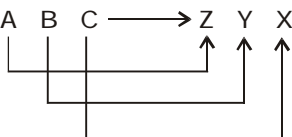

Pairs of Opposite Letters

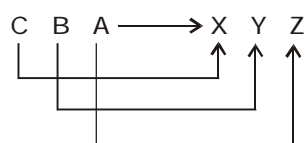

153. (4)

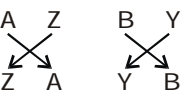

Similarly,

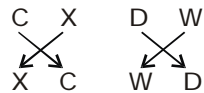

154. (1)

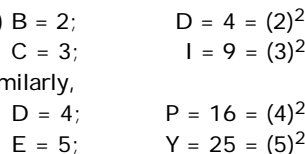

155. (1)

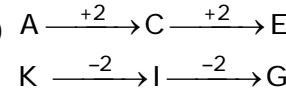

Similarly,

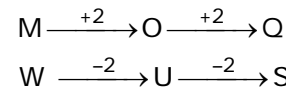

156. (2)

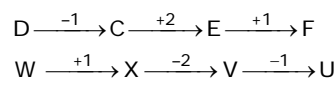

Similarly,

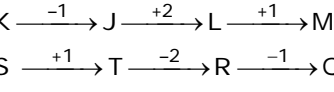

157. (2)

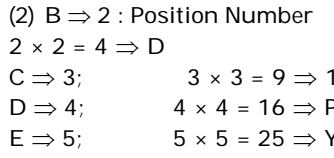

158. (1)

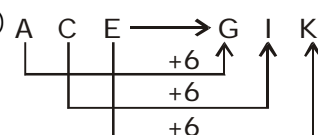

Similarly,

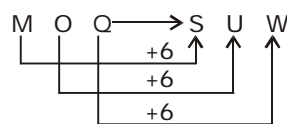

159. (1)

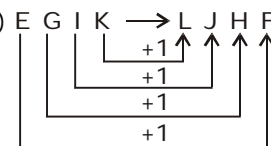

Similarly,

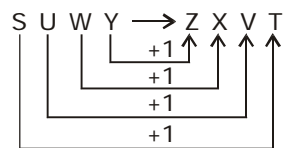

160. (1)

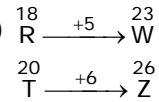

Similarly,

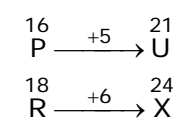

ANALOGY OR SIMILARITY

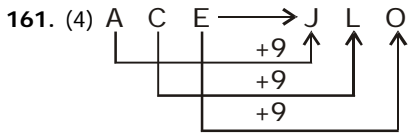

Similarly,

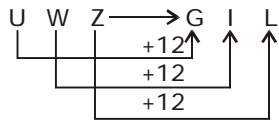

162. (3)

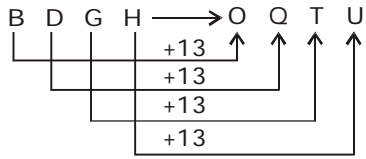

Similarly,

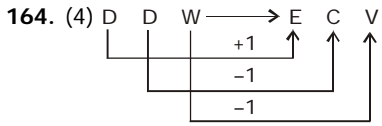
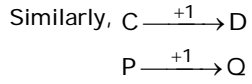
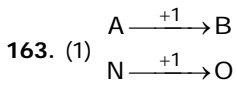
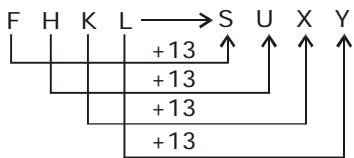

Similarly,

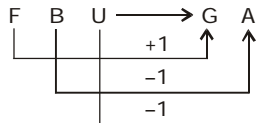

165. (3)

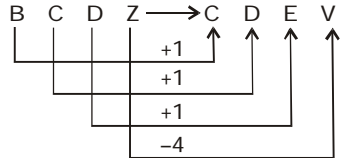

Similarly,

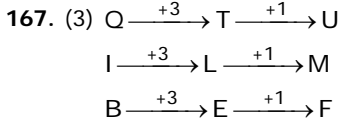
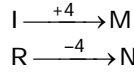
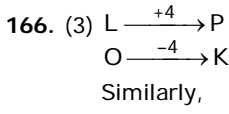
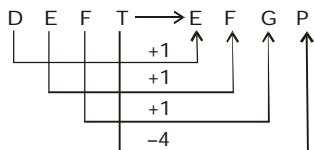

Similarly,

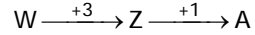

168. (4)

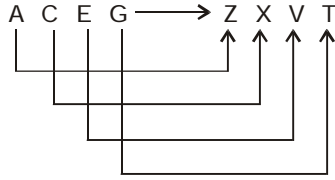

Pairs of opposite letters.

Similarly,

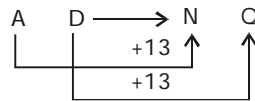
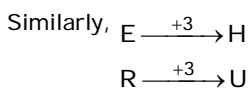
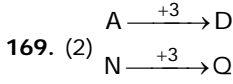
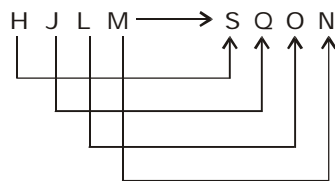

Similarly,

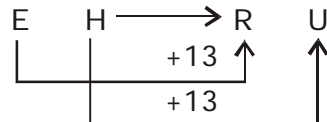

170. (1)

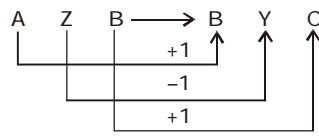

Similarly,

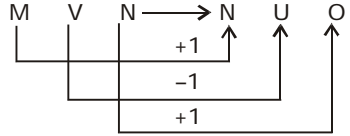

171. (2)

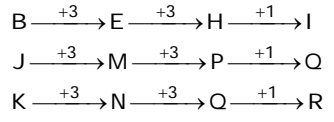

Similarly,

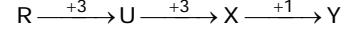

172. (1) The pairs of Opposite letters are given.

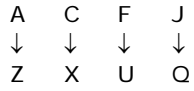

Similarly,

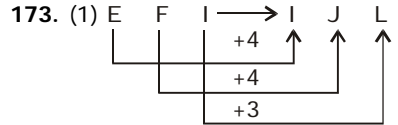
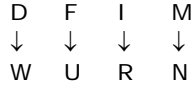

Similarly,

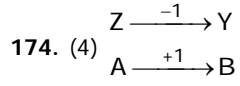
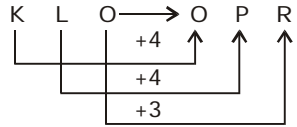

Similarly,

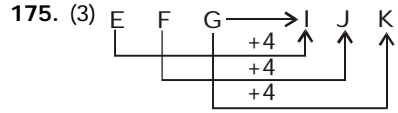
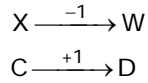

Similarly,

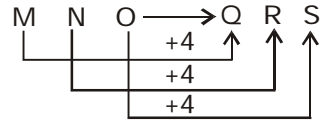

176. (3) RAT ⇒ TAR (Reverse order)  
 Similarly,  
 PIT ⇒ TIP

**ANALOGY OR SIMILARITY**

177. (3)

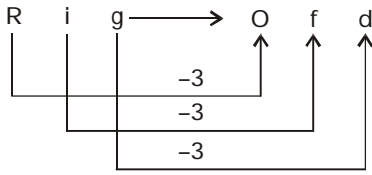

Similarly,

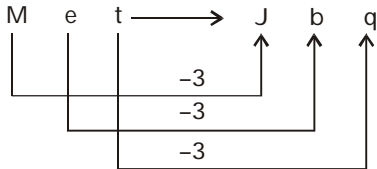

178. (1)

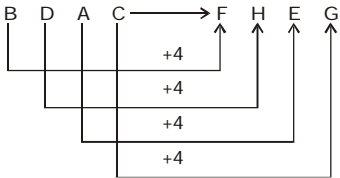

Similarly,

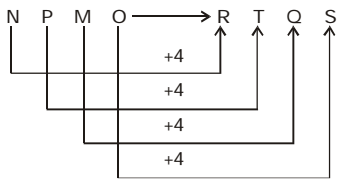

179. (1)

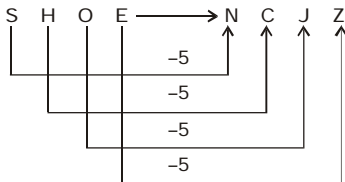

Similarly,

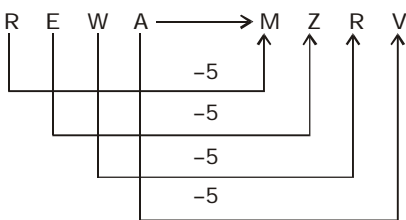

180. (2)

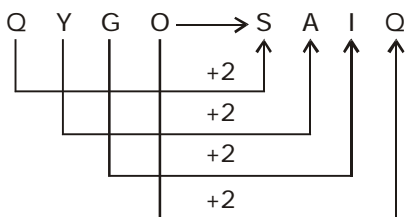

Similarly,

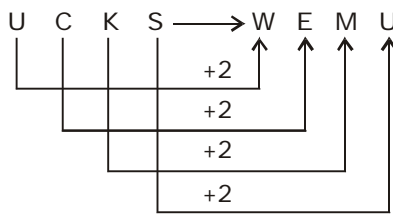

181. (2)

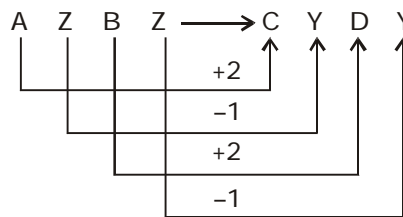

Similarly,

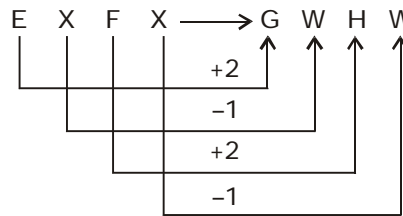

182. (3)

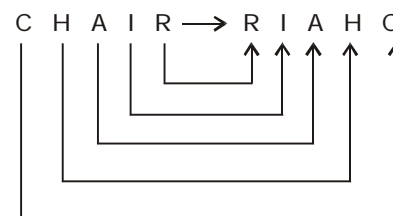

The letters have been written in the reverse order.  
Similarly,

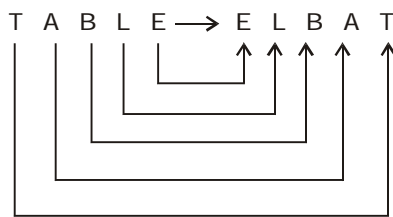

183. (1)

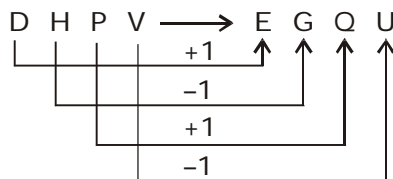

Similarly,

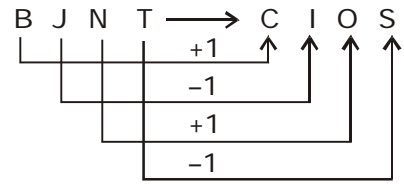

184. (4) x x y z y y  
↓ ↓ ↓ ↓ ↓ ↓

c c b a b b

Pairs of opposite letters  
Therefore,

x y y z z y

↓ ↓ ↓ ↓ ↓ ↓

c b b a a b

185. (2)

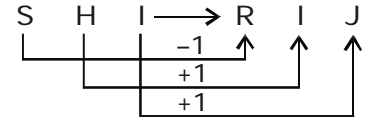

Similarly,

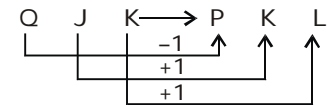

186. (4) B E H K → P S V Y

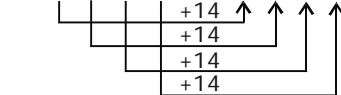

Similarly,

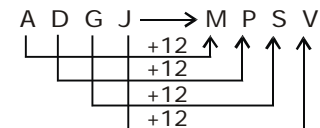

187. (3)

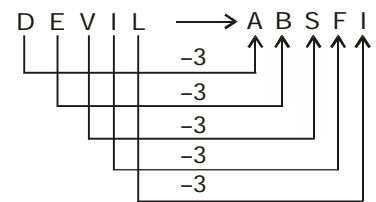

Similarly,

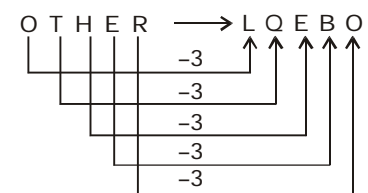

**ANALOGY OR SIMILARITY**

188. (2)

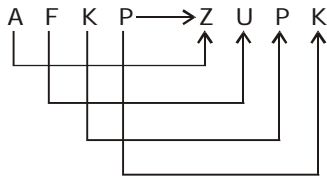

Pairs of Opposite Letters.  
Similarly,

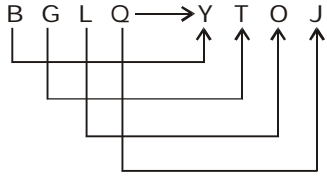

189. (4)

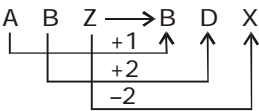

Similarly,

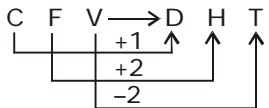

190. (4)

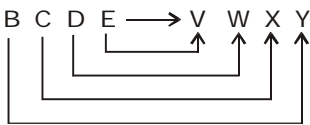

Pairs of Opposite Letters.  
Similarly,

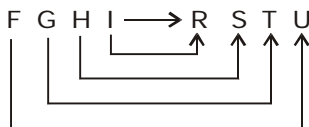

191. (3)

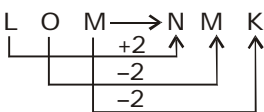

Similarly,

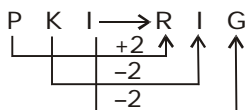

192. (1)

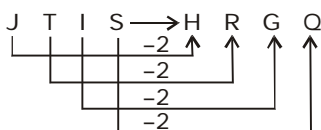

Similarly,

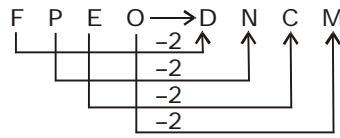

193. (4)

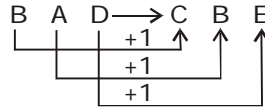

Similarly,

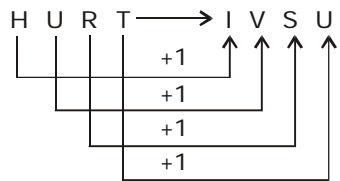

194. (3) The opposite letter of J is Q.

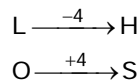

The opposite letter of F is U.

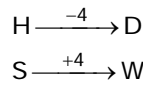

Therefore, ? = USUW

195. (2)

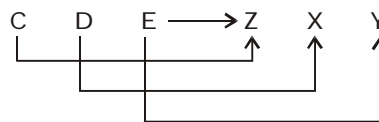

Similarly,

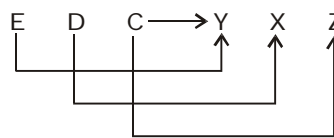

196. (3)

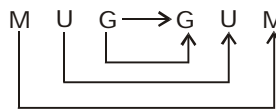

Similarly,

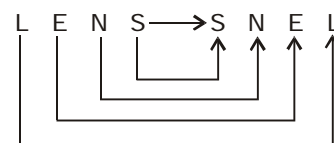

197. (4)

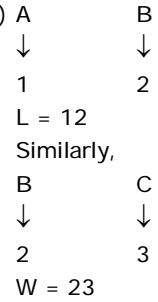

198. (3)

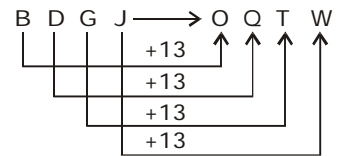

Similarly,

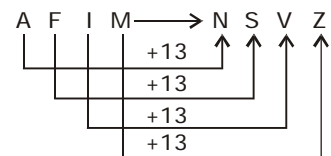

199. (1)

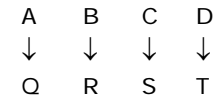

So,

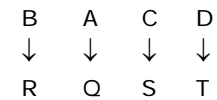

200. (3)

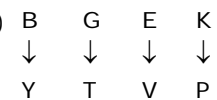

Pairs of Opposite Letters

So,

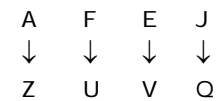

201. (1)

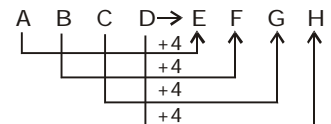

Similarly,

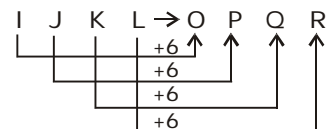

**ANALOGY OR SIMILARITY**

202. (3)

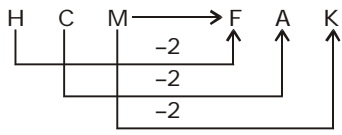

Similarly,

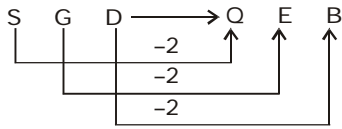

203. (2)

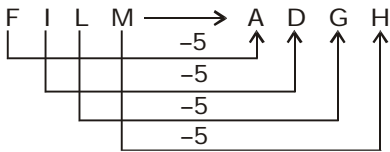

Similarly,

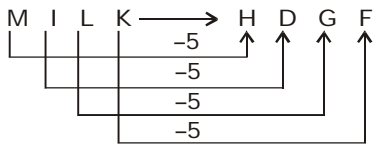

204. (4)

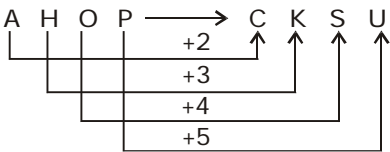

Similarly,

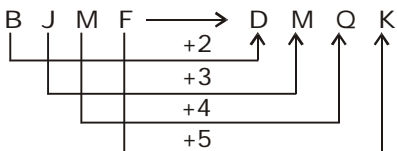

205. (4)

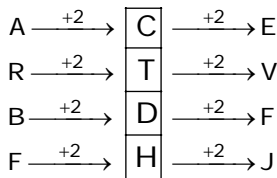

206. (4)

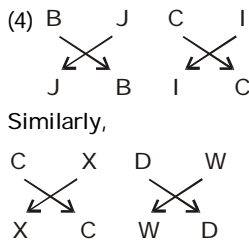

207. (4)

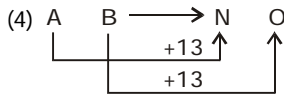

Similarly,

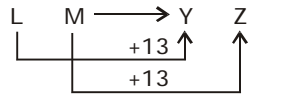

208. (2)



Similarly,

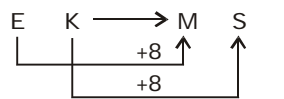

209. (1)

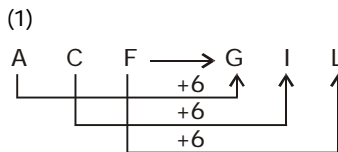

Similarly,

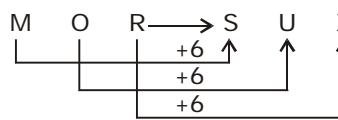

210. (4)

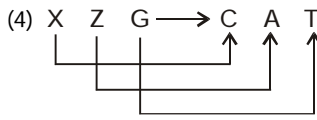

Pairs of Opposite letters.

Similarly,

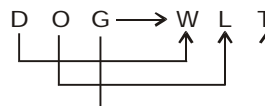

211. (2)

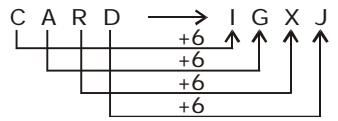

Similarly,

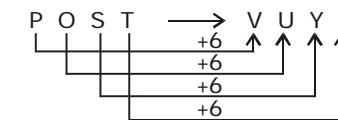

212. (4)

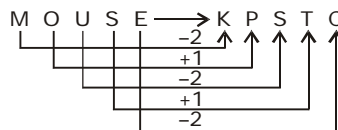

Similarly,

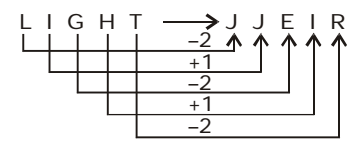

213. (3)

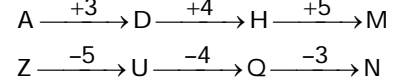

Similarly,

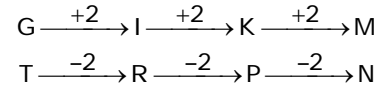

214. (4)

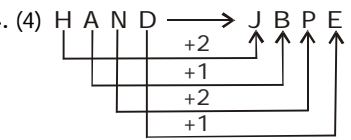

Similarly,

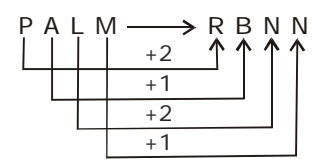

215. (1)

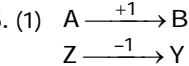

Similarly,

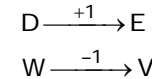

216. (1)

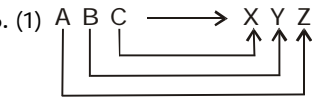

Pairs of Opposite Letters.

Similarly,

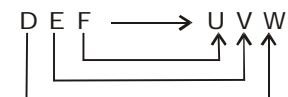

217. (4)

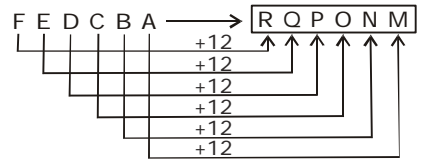

**ANALOGY OR SIMILARITY**

Similarly,

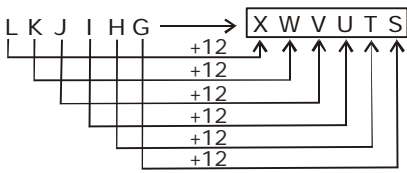

218. (3)

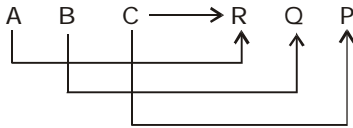

Similarly,

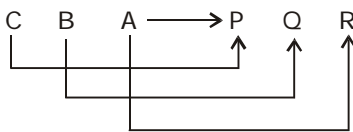

219. (3)

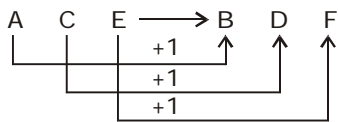

Similarly,

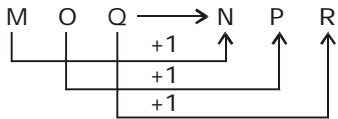

220. (2)

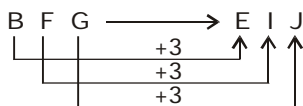

Similarly,

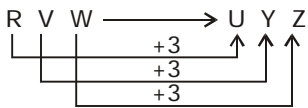

221. (1)

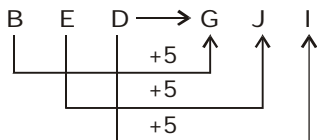

Similarly,

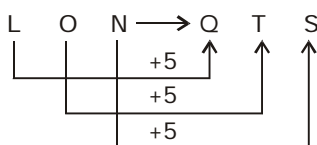

222. (2)

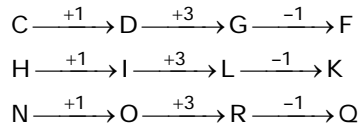

Similarly,

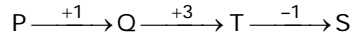

223. (2)

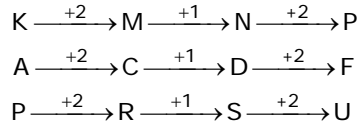

But,

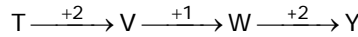

224. (3)

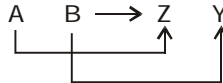

Pairs of opposite letters.

Similarly,

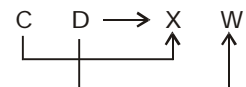

225. (2) The letters have been written in the reverse order.

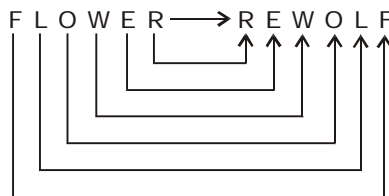

Similarly,

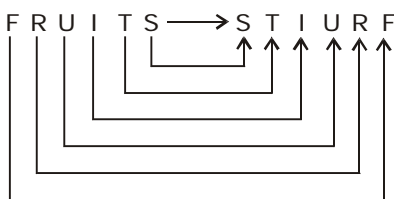

226. (3)

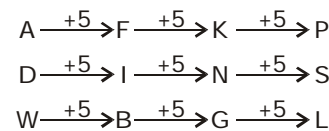

Similarly,

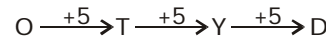

227. (\*)

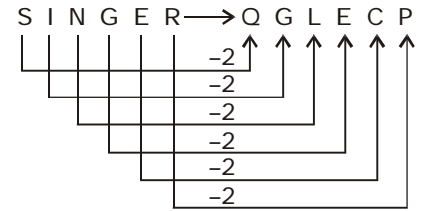

Similarly,

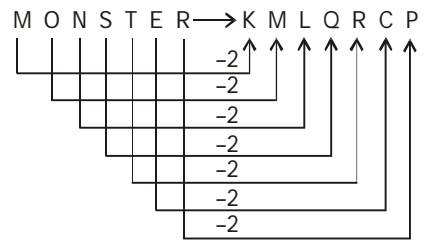

228. (1)

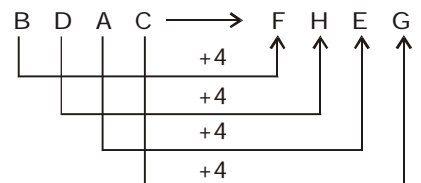

Similarly,

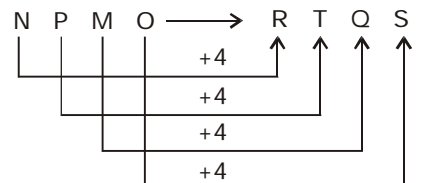

229. (4)

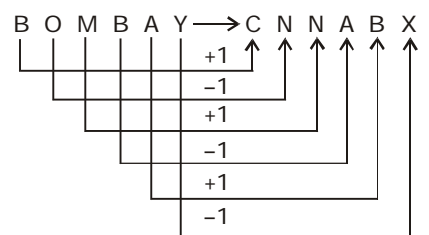

Therefore,

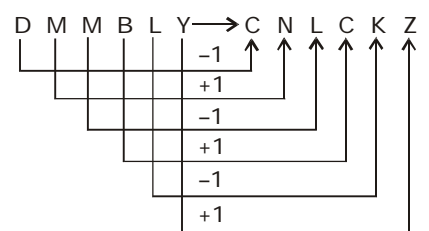

ANALOGY OR SIMILARITY

230. (1)

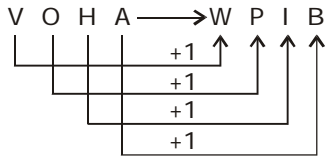

Similarly,

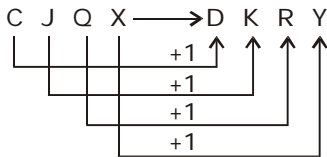

231. (4)

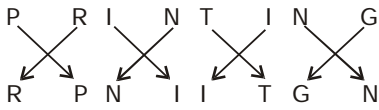

Similarly,

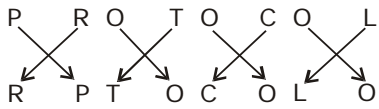

232. (1)

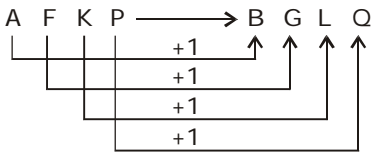

Similarly,

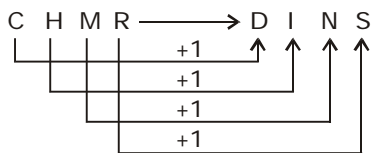

233. (3)

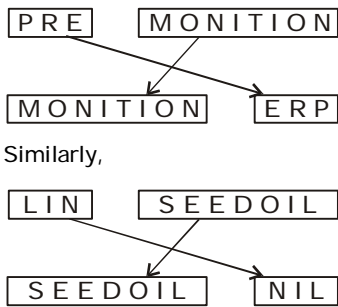

234. (3)

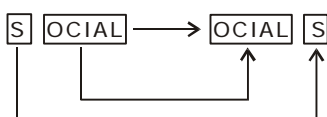

Similarly,

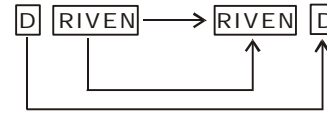

235. (3)

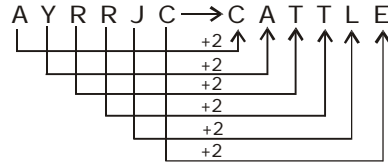

Similarly,

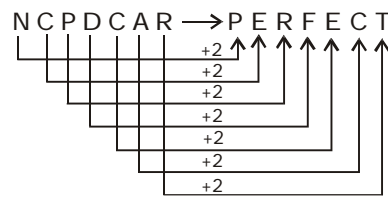

236. (3)

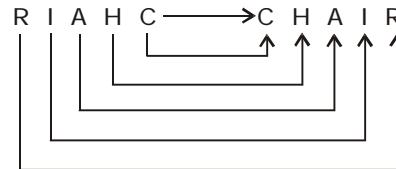

Letters have been written in the reverse order.

Similarly,

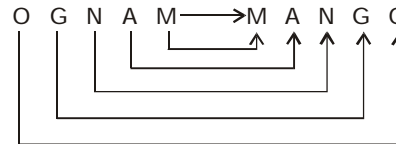

237. (3)

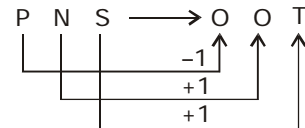

Similarly,

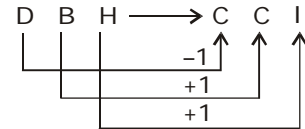

238. (2)

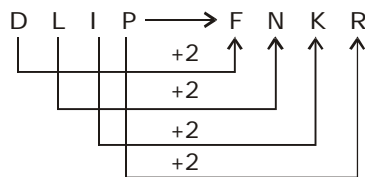

Similarly,

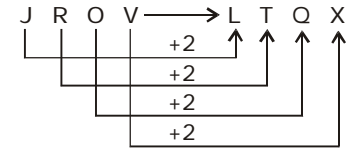

239. (1)

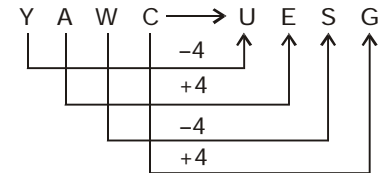

Similarly,

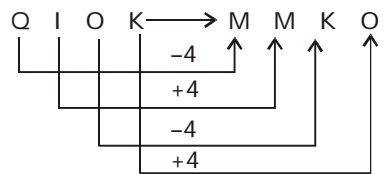

240. (3)

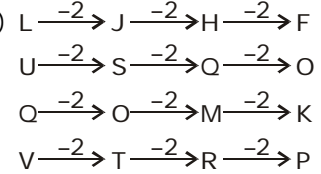

241. (2)

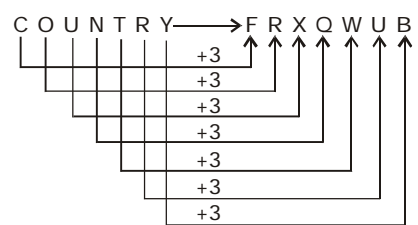

Similarly,

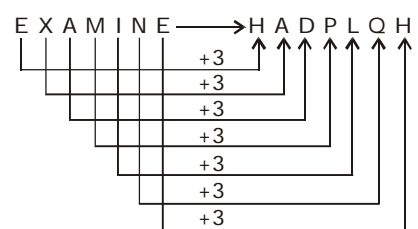

242. (2)

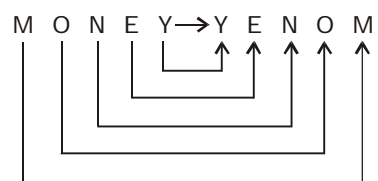

Reverse order to letters

**ANALOGY OR SIMILARITY**

Similarly,

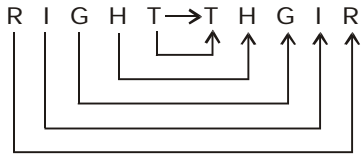

243. (2) From the jumbled letters NII-OLUSL, we can form the meaningful word ILLUSION. Similarly, we can form VERTEBRA from the jumbled letters TBERVARE.

244. (4)

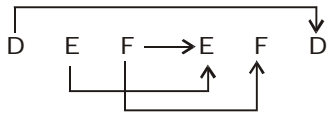

Similarly,

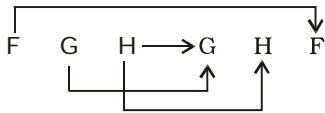

245. (1)

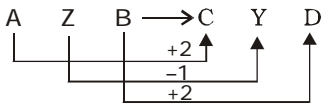

Similarly,

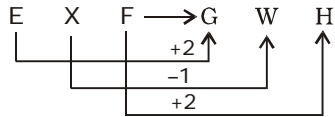

246. (4) HGUOR ⇒ ROUGH  
HTOOMS ⇒ SMOOTH  
ROUGH is just opposite of SMOOTH.

Similarly,

REDNET ⇒ TENDER

TOUGH is just opposite of TENDER.

TOUGH ⇒ HGUOT

247. (1) Z X -> A C

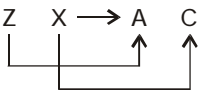

Pairs of opposite letters.

Similarly,

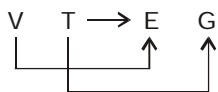

248. (3) ABC; DEF; GHI; JKL

XYZ; UVW; RST; OPQ

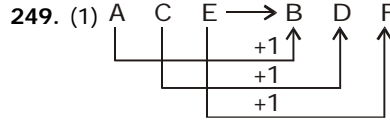

Similarly,

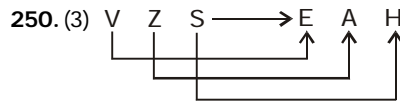
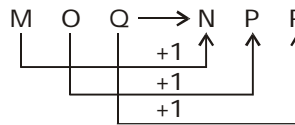

Pairs of Opposite Letters

Similarly,

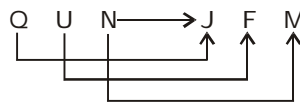

251. (2)

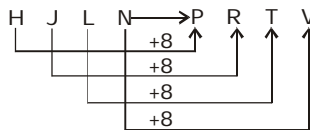

Similarly,

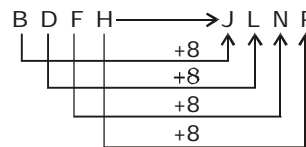

252. (3) D L O C ⇒ C O L D

E C I ⇒ I C E

ICE is COLD.

TOH ⇒ HOT

AET ⇒ TEA

TEA is HOT.

253. (1)

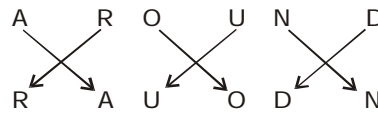

Similarly,

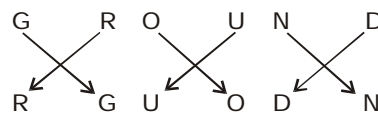

254. (2)

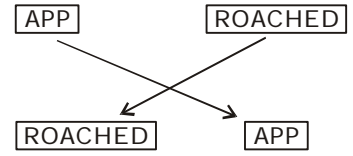

Similarly,

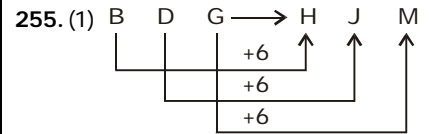
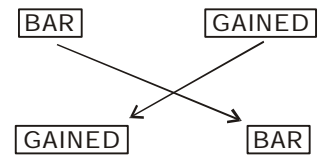

Similarly,

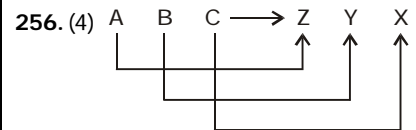
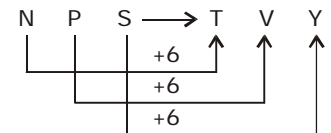

Pairs of Opposite letters.

Similarly,

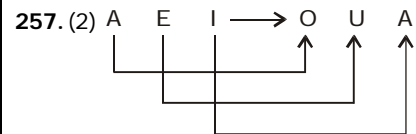
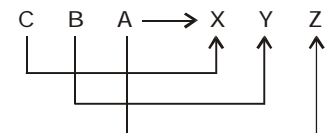

Similarly,

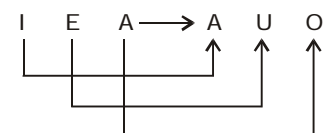

258. (1) C -> I (+6)

Similarly,

D -> L (+8)

**ANALOGY OR SIMILARITY**

259. (4) YAD ⇒ DAY  
 NUS ⇒ SUN  
 Similarly,  
 THGIN ⇒ NIGHT  
 NOOM ⇒ MOON

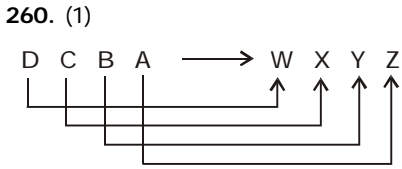

Pairs of Opposite Letters.  
 Similarly,

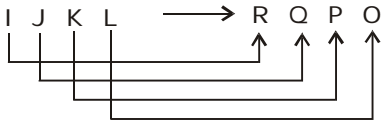

261. (3) The habitat of bee is called hive. Hive is a structure made for bees. Similarly, eyrie is a nest that is built high up among rocks by a bird of prey such as an eagle.

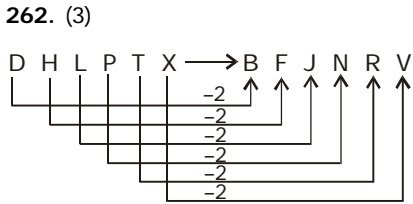

Similarly,

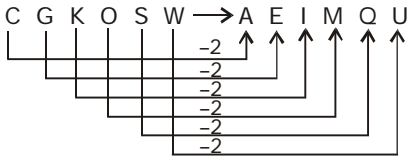

263. (4) D : B :: I : C  
 ↓ ↓ ↓ ↓  
 4 2 9 3

The square of the position number of the second letter is the position number of the first letter in each unit. Therefore,  
 P : D and Y : E  
 ↓ ↓ ↓ ↓  
 16 4 25 5

264. (3) A : B :: B : D  
 ↓ ↓ ↓ ↓  
 1 2 2 4  
 $1 \times 2 = 2$ ;  $2 \times 2 = 4$   
 Similarly,  
 C : F ⇒  $3 \times 2 = 6$   
 ↓ ↓  
 3 6

And,  
 F : L  
 ↓ ↓  
 6 12  
 $6 \times 2 = 12$

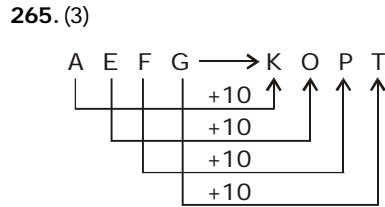

Similarly,

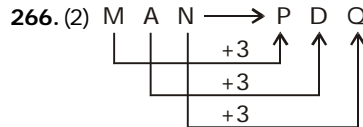
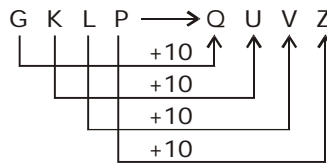

Similarly,

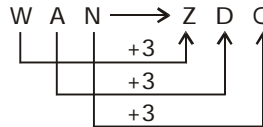

267. (4)  $\sqrt{AFI} = M$   
 $\Rightarrow \sqrt{169} = 13$   
 $\sqrt{ADD} = L$   
 $\Rightarrow \sqrt{144} = 12$   
 Similarly,

$\sqrt{ABA} = \sqrt{121} = 11 = K$

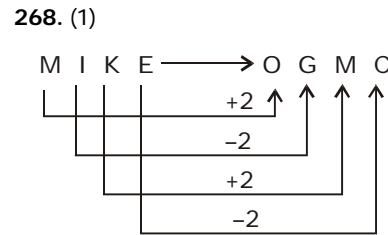

Similarly,

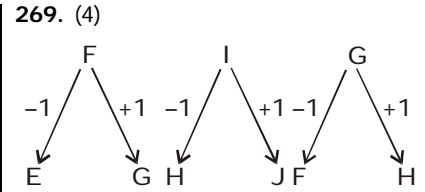
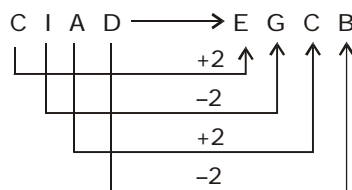

Similarly,

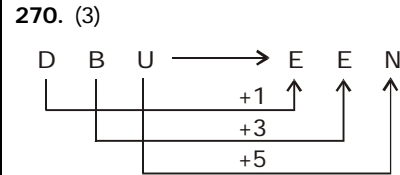
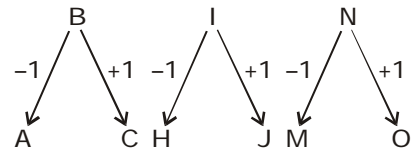

Similarly,

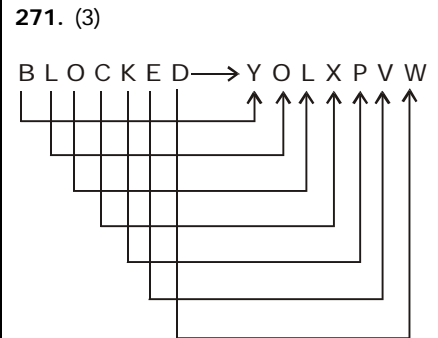
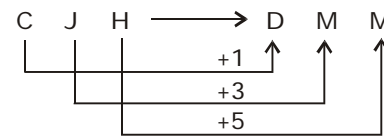

Pairs of opposite letters.

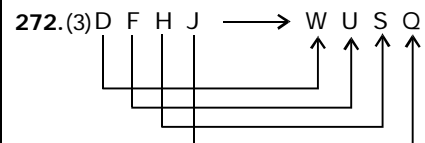
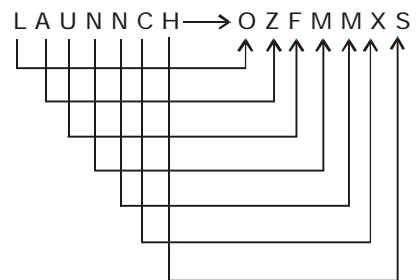

Pairs of opposite letters.

**ANALOGY OR SIMILARITY**

Similarly,

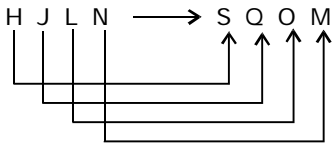

273. (1)

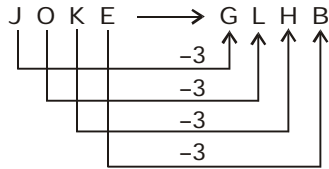

Similarly,

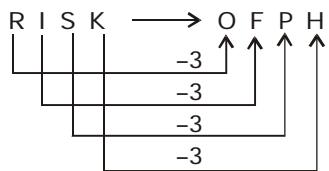

274. (4)

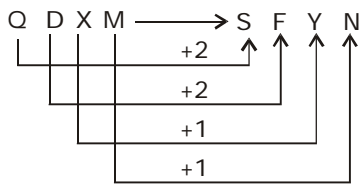

Similarly,

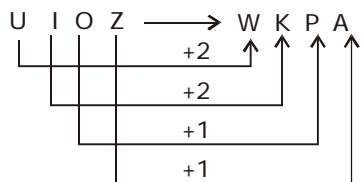

275. (4)

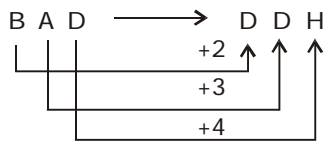

Similarly,

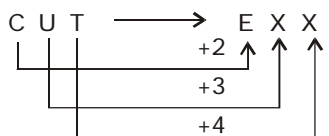

276. (3)

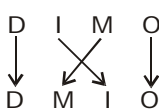

Similarly,



277. (2)

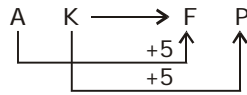

Similarly,

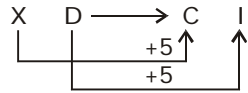

278. (4)

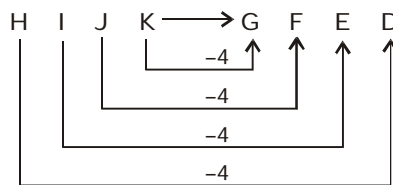

Similarly,

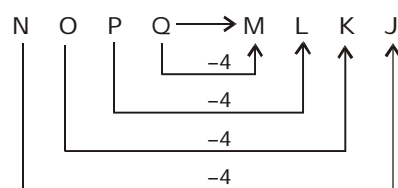

279. (3)

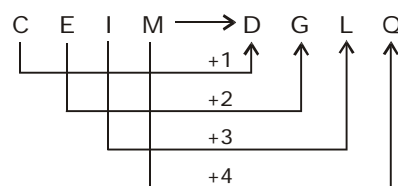

Similarly,

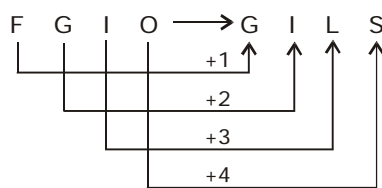

280. (1)

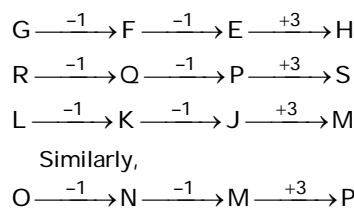

281. (4)  $(4 + 2)^2 = (6)^2 = 36$

Similarly,

$(5 + 2)^2 = (7)^2 = 49$

282. (1)

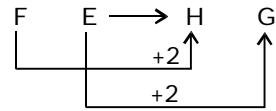

Similarly,

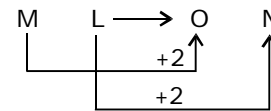

283. (1)

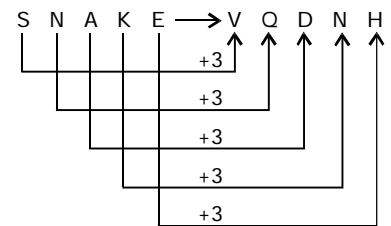

Similarly,

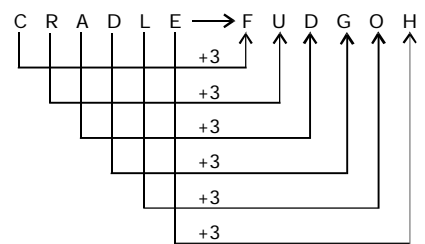

284. (3)

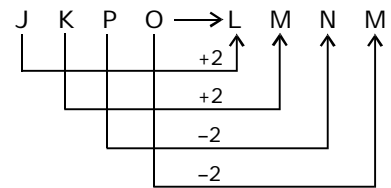

Similarly,

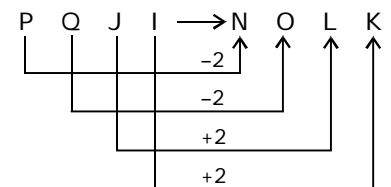

285. (3)

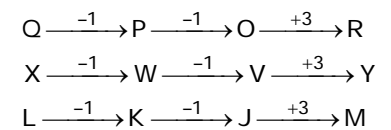

**ANALOGY OR SIMILARITY**

Therefore,

$$C \xrightarrow{-1} B \xrightarrow{-1} A \xrightarrow{+3} D$$

286. (4)  $V \xrightarrow{+2} X \xrightarrow{+1} Y$   
 $R \xrightarrow{+2} T \xrightarrow{+1} U$   
 $F \xrightarrow{+2} H \xrightarrow{+1} I$

Similarly,

$$S \xrightarrow{+2} U \xrightarrow{+1} V$$

287. (4)

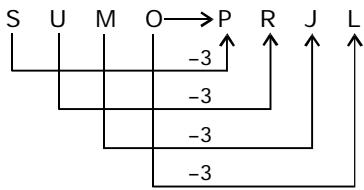

Similarly,

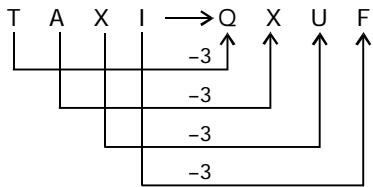

288. (4)  $P \xrightarrow{+6} V$   
 $S \xrightarrow{+6} Y$

Similarly,

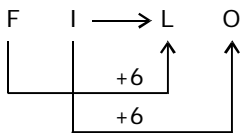

289. (2)

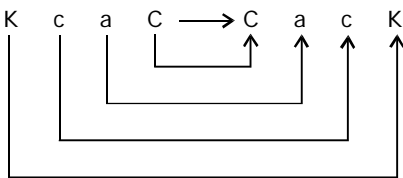

Reverse order of letters.

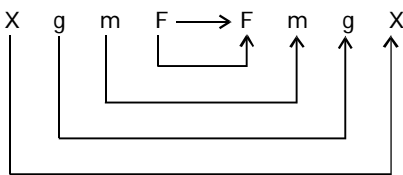

290. (2)

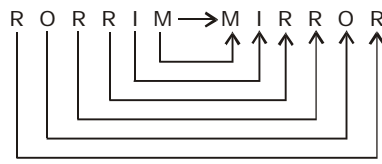

Similarly,

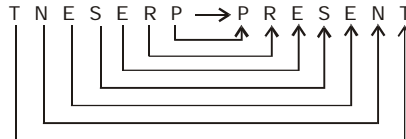

291. (4)

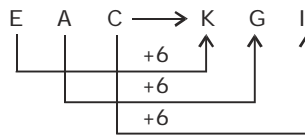

Similarly,

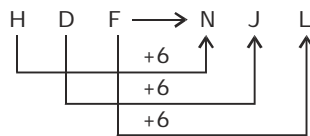

292. (1)

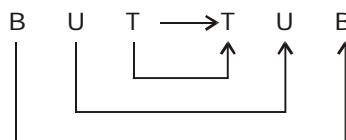

Similarly,

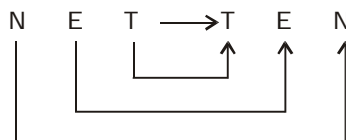

293. (\*)

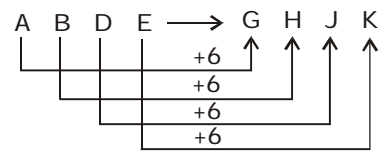

Similarly,

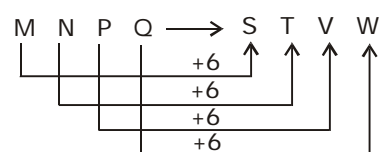

294. (1)  $A \xrightarrow{+6} G$   
 $C \xrightarrow{+6} I$   
 $E \xrightarrow{+6} K$

Similarly,

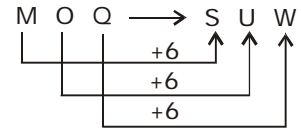

295. (1)

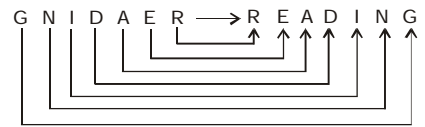

Similarly,

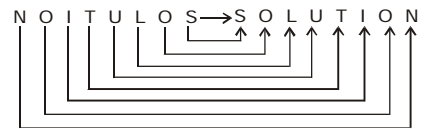

296. (4)  $C \xrightarrow{+1} D$   
 $A \xrightarrow{+3} D$   
 $T \xrightarrow{+5} Y$

Similarly,

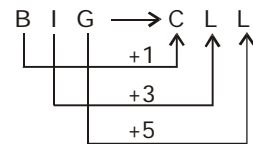

297. (3)

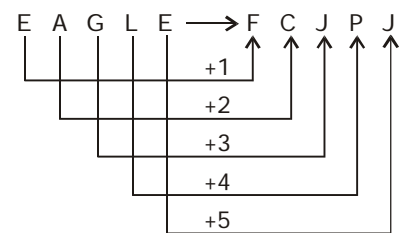

Similarly,

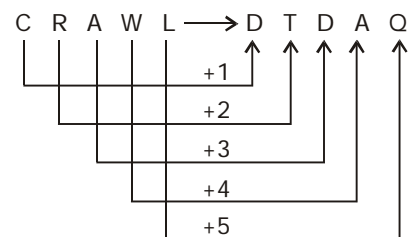

**ANALOGY OR SIMILARITY**

298. (1)

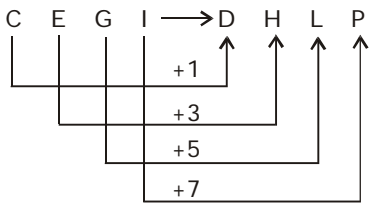

Similarly,

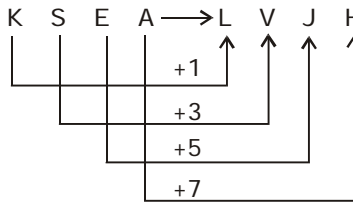

299. (2)

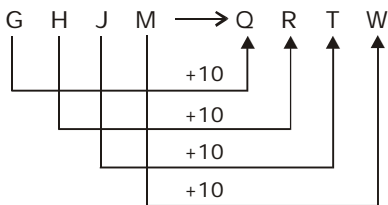

Similarly,

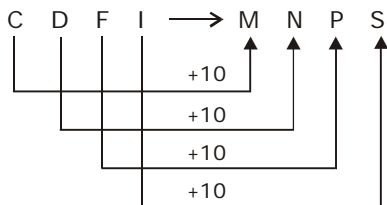

300. (2)

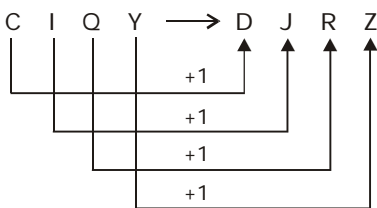

Similarly,

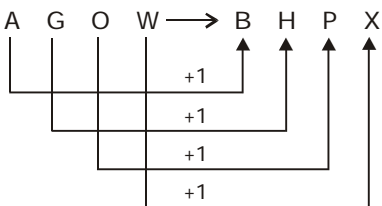

301. (2)

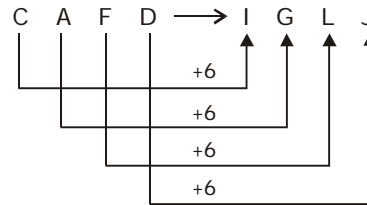

Similarly,

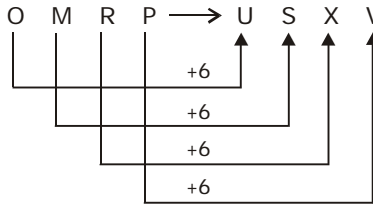

302. (3)

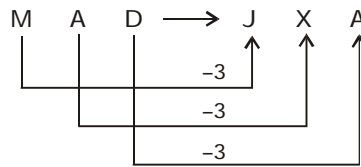

Similarly,

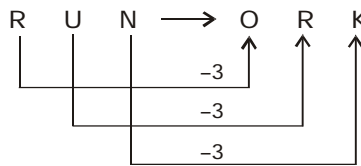

303. (4)

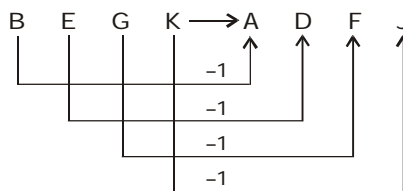

Similarly,

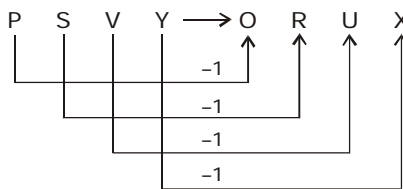

304. (2)

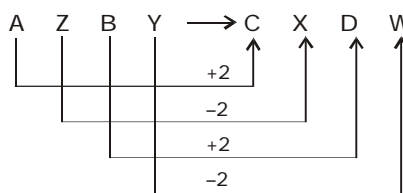

Similarly,

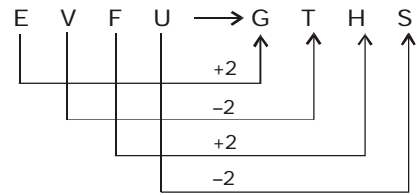

305. (2) R I G T → W D B Y

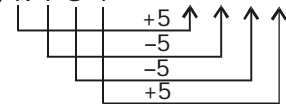

Similarly,

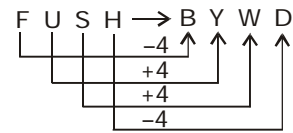

306. (3) D C B A → W X Y Z

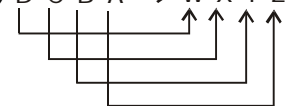

Pairs of opposite letters.

Similarly,

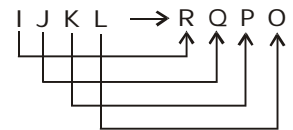

307. (1)

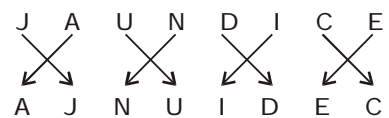

Similarly,

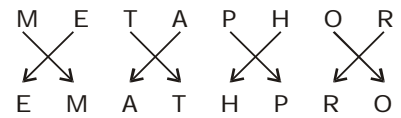

308. (2)

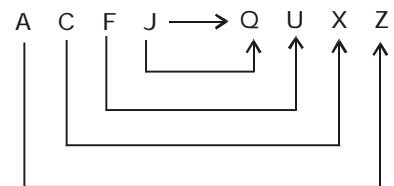

Pairs of opposite letters.

**ANALOGY OR SIMILARITY**

Similarly,

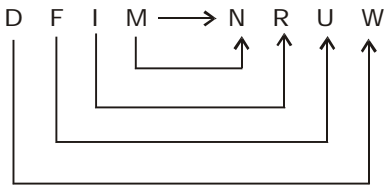

309. (2)

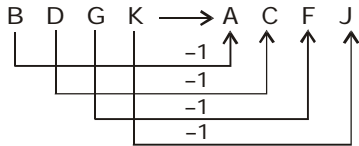

Therefore,

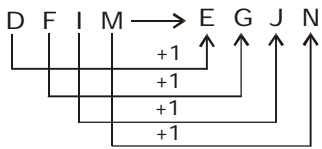

310. (3)

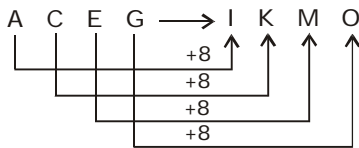

Similarly,

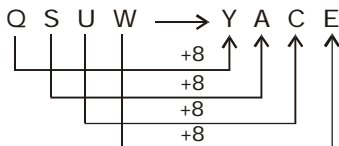

311. (4) The R : ARE exhibit the same pronunciation. Similarly, U : YOU exhibit the same pronunciation.

312. (3)

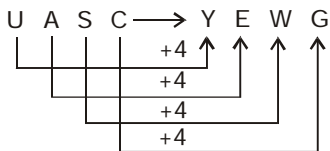

Similarly,

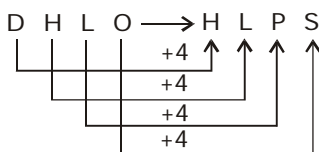

313. (3)

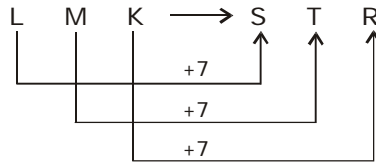

Uniform distance between the letters.

Similarly,

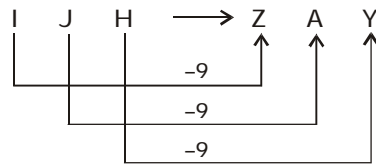

314. (2)

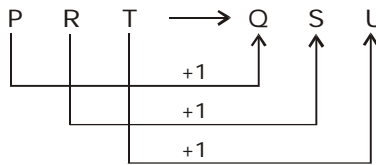

Similarly,

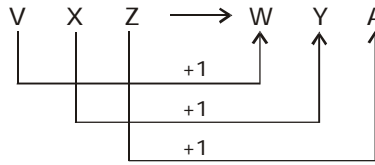

315. (1)

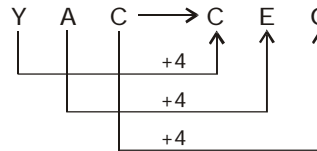

Similarly,

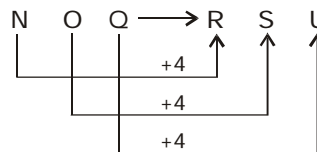

316. (1)

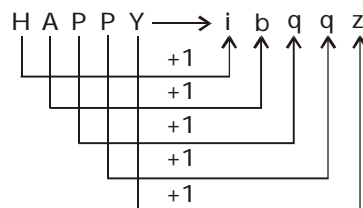

Similarly,

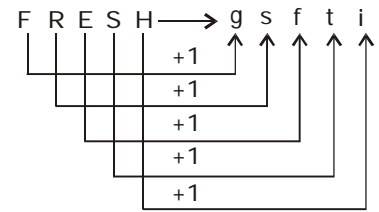

317. (4)

1 2 3 4 5 6 7    2 4 6  
G A Y A T R I ⇒ A A R

Similarly,

1 2 3 4 5 6 7    2 4 6  
P A L L A V I ⇒ A L V

318. (1)

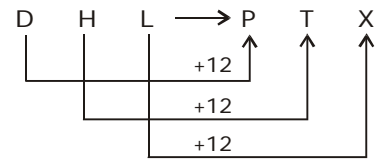

Similarly,

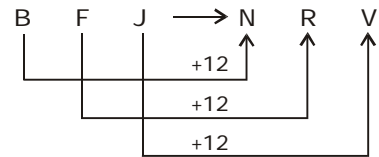

319. (2)

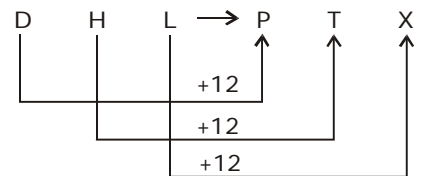

Similarly,

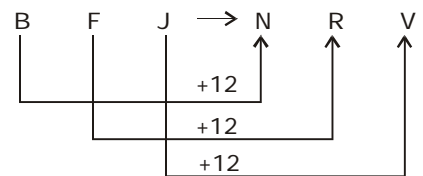

320. (3)

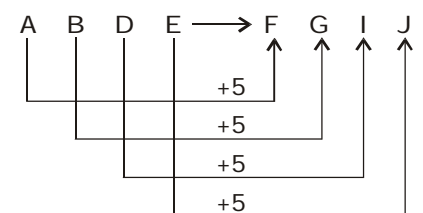

**ANALOGY OR SIMILARITY**

Similarly,

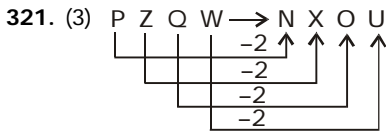
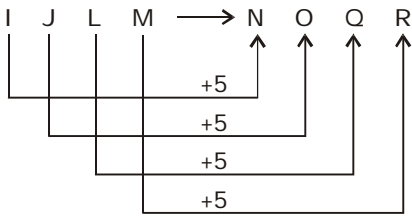

Similarly,

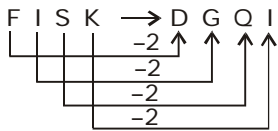

**322. (1)**

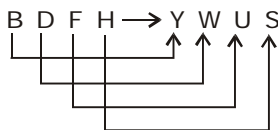

Pairs of opposite letters.

Similarly,

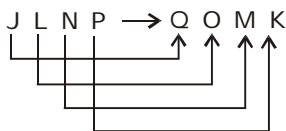

**323. (\*)**

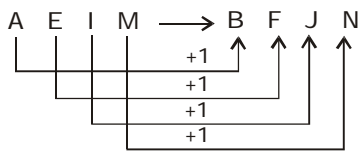

Similarly,

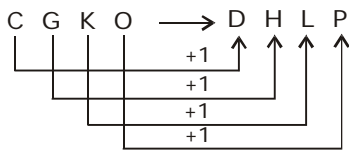

**324. (2)**

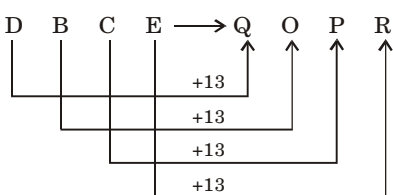

Similarly,

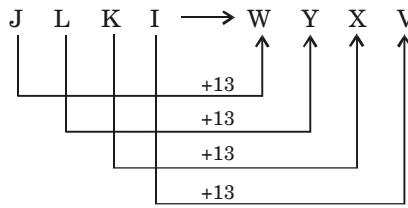

**325. (4)**

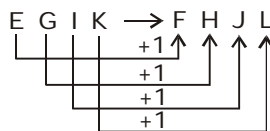

Similarly,

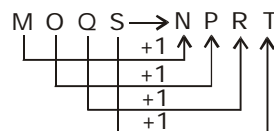

**326. (4)**

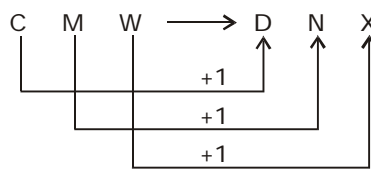

Similarly,

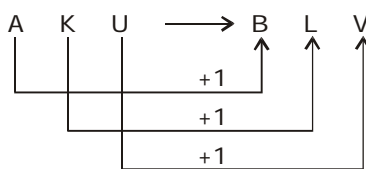

**327. (2)**

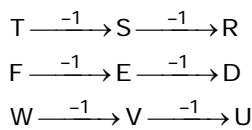

Similarly,

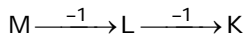

**328. (1)**

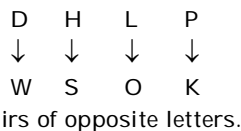

Pairs of opposite letters.

Similarly,

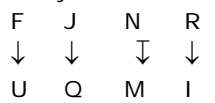

**329. (3)**

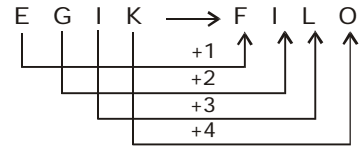

Similarly,

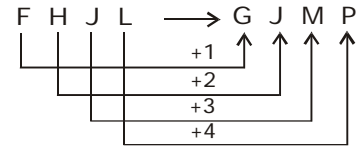

**330. (2)**

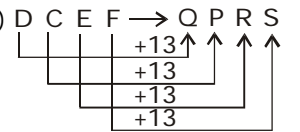

Similarly,

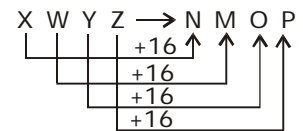

**331. (1)**

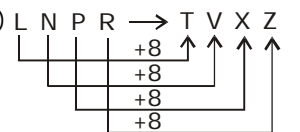

Similarly,

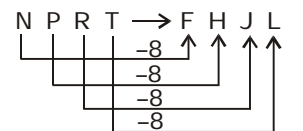

**332. (2)**

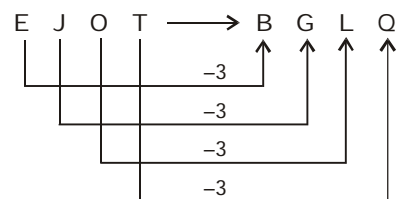

Similarly,

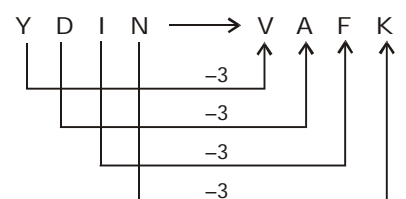

**ANALOGY OR SIMILARITY**

333. (1)

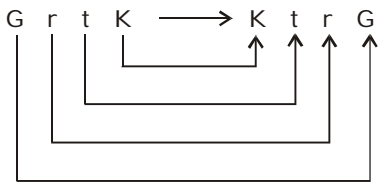

Reverse order of letters.

Similarly,

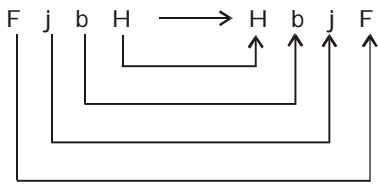

334. (3)

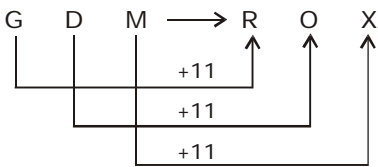

Similarly,

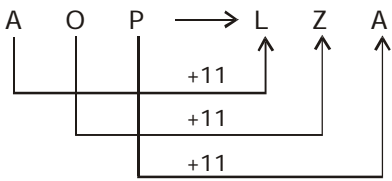

335. (1)

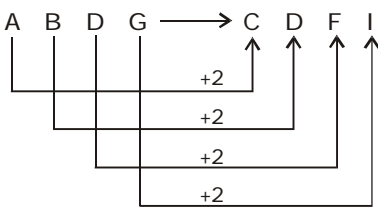

Similarly,

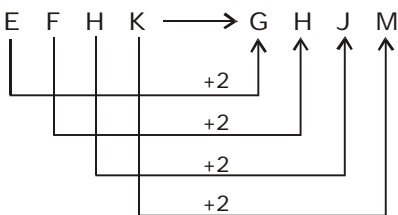

336. (4)

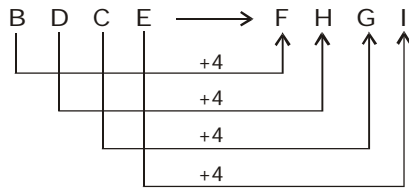

Similarly,

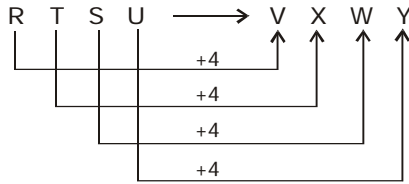

337. (2)

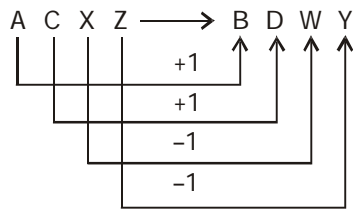

Similarly,

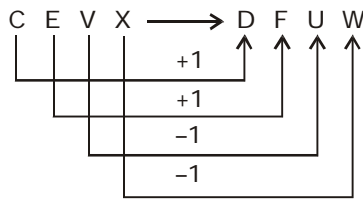

338. (3)

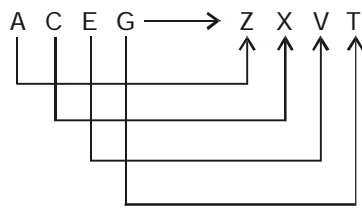

Pairs of opposite letters.

Similarly,

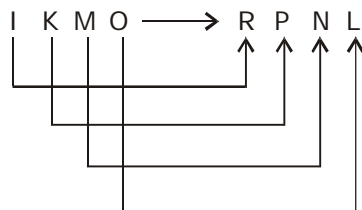

339. (3)

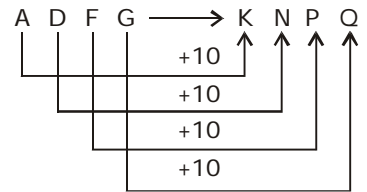

Similarly,

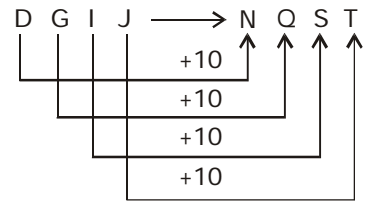

340. (2)

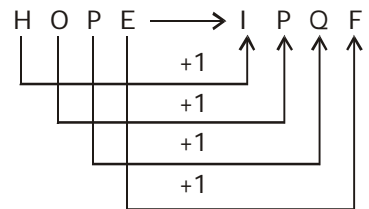

Similarly,

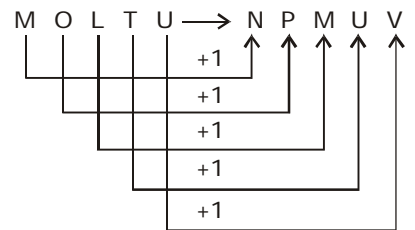

341. (3)

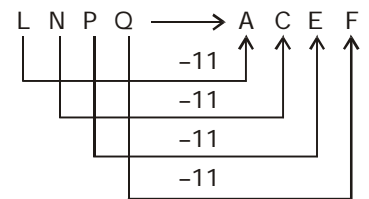

Similarly,

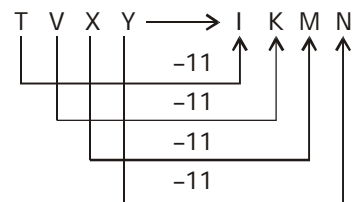

**ANALOGY OR SIMILARITY**

342. (3)

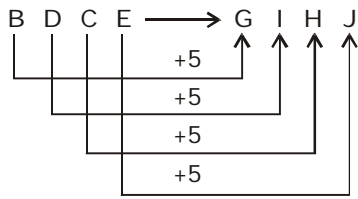

Similarly,

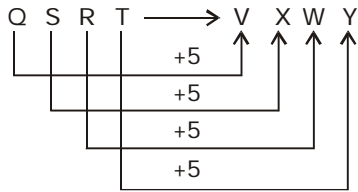

343. (2)

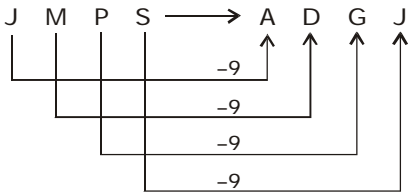

Similarly,

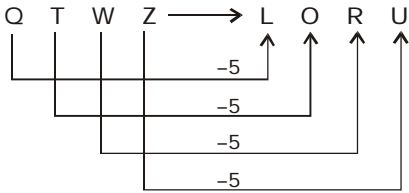

Alternatively,

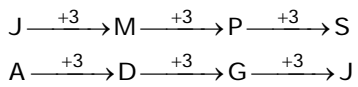

Similarly,

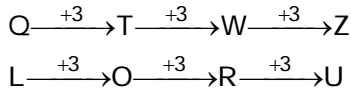

344. (2)

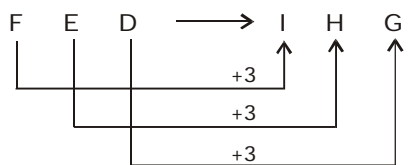

Similarly,

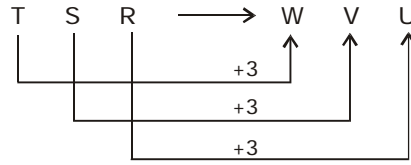

345. (2)

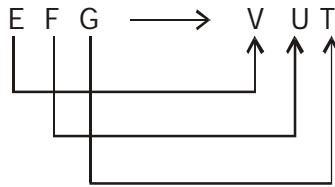

Pair of opposite letters.  
 Similarly,

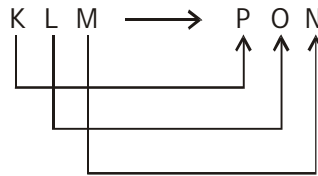

346. (2)

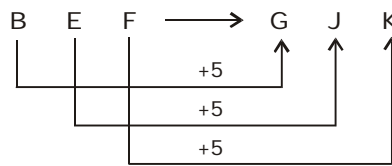

Similarly,

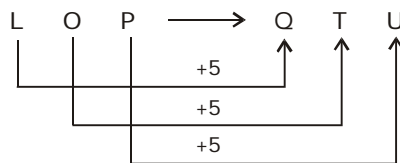

347. (2)

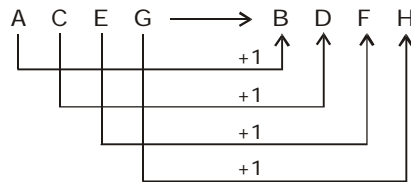

Similarly,

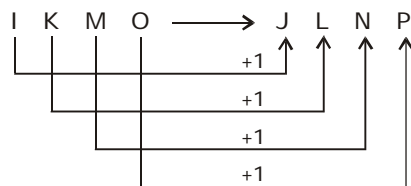

348. (3)

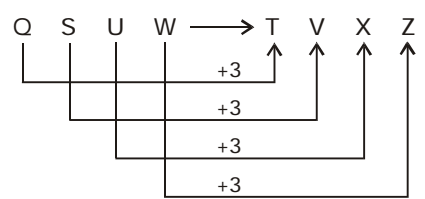

Similarly,

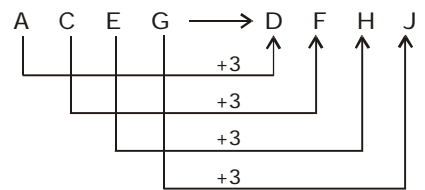

349. (1)

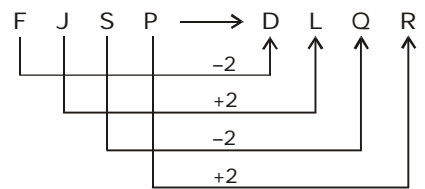

Similarly,

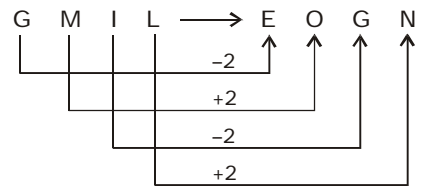

350. (3)

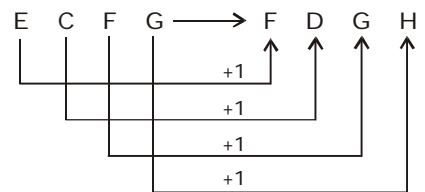

Similarly,

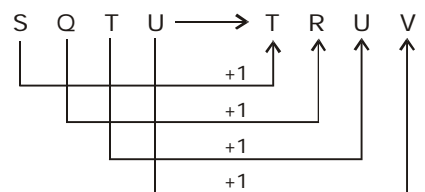

**ANALOGY OR SIMILARITY**

351. (2)

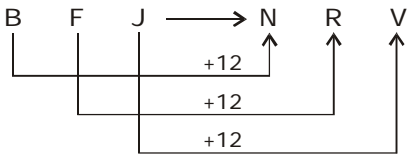

Similarly,

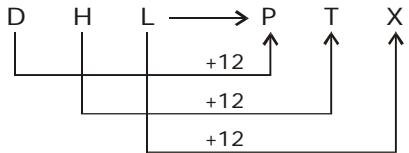

352. (1)

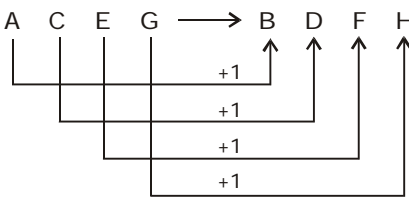

Similarly,

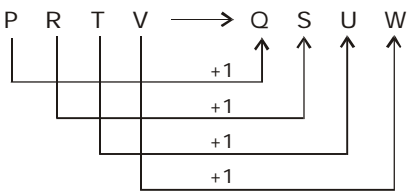

353. (2) Z X V T

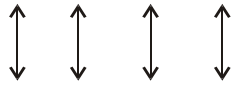

Pairs of opposite letters.

Similarly,

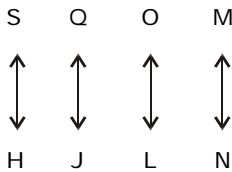

354. (1)

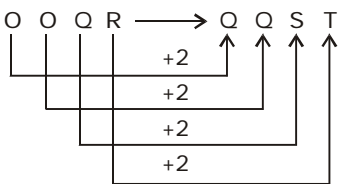

Similarly,

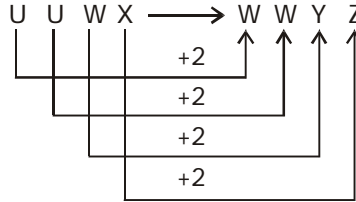

355. (4)

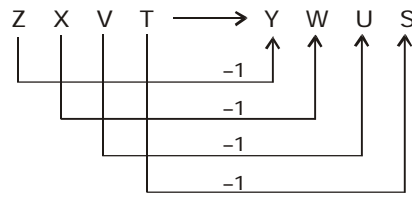

Similarly,

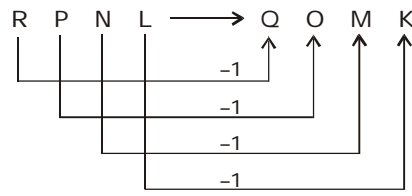

356. (4)

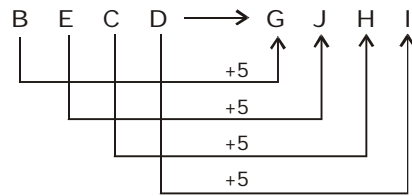

Similarly,

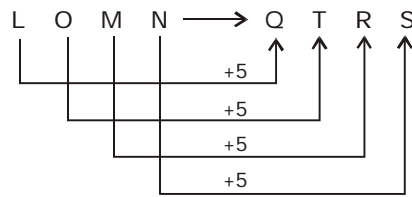

357. (3)

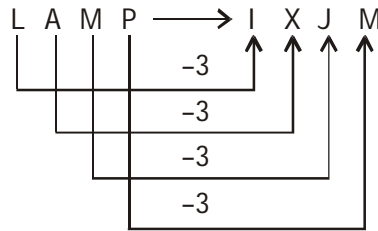

Similarly,

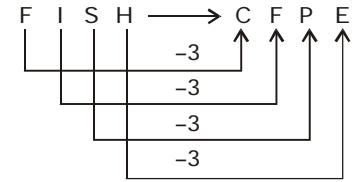

358. (3)

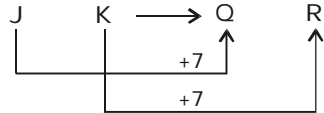

Similarly,

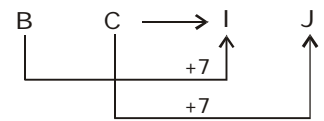

359. (1)

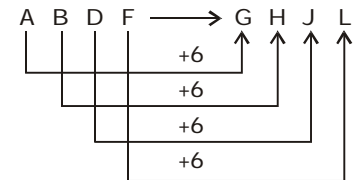

Similarly,

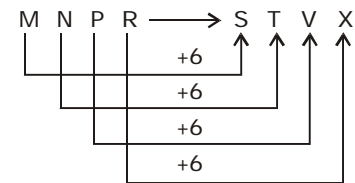

360. (2)

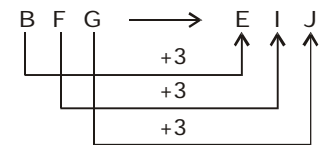

Similarly,

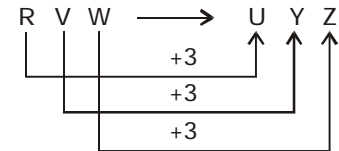

361. (3)

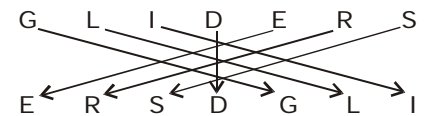

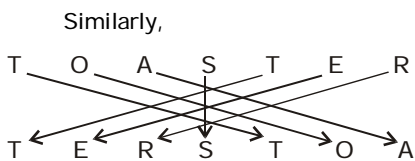

362. (2)

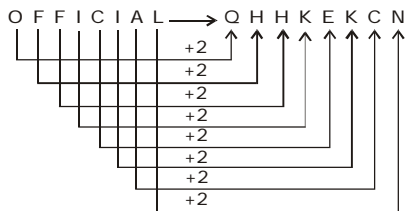

Similarly,

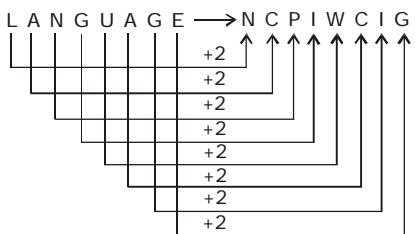

363. (3)

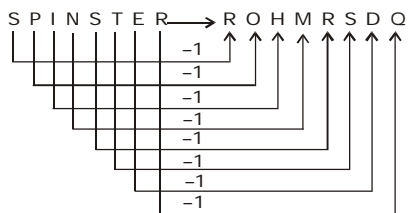

Similarly,

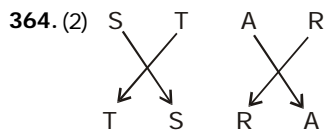
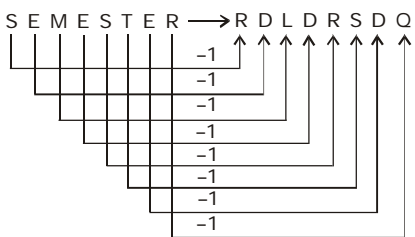

Similarly,

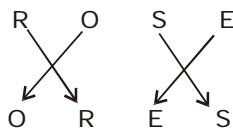

TYPE-V

1. (2) D E



Position Number in English alphabet.

Similarly,

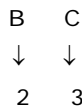

2. (2) C ⇒ 3

$(3 + 1)^2 = 16$

$F \Rightarrow 6$

$(6 + 1)^2 = 49$

3. (3) D E : 10



$(4 \times 5) \div 2 = 10$

$\therefore H I : 36$



$(8 \times 9) \div 2 = 36$

4. (1) Position Numbers of C and E = 3 and 5

$CE \rightarrow 35 \times 2 = 70$

Similarly,

$DE = 45 \times 2 = 90$

5. (2) Subtract the position number of each letter from 26 to get the value of each letter.

$M \Rightarrow 26 - 13 = 13$

$O \Rightarrow 26 - 15 = 11$

Similarly,

$H \Rightarrow 26 - 8 = 18$

$J \Rightarrow 26 - 10 = 16$

6. (3) Position Numbers in English alphabet are given.

7. (2)  $\frac{T}{J} : 2 \Rightarrow \frac{20}{10} = 2$

Therefore,

$\frac{X}{H} \Rightarrow \frac{24}{8} = 3$

8. (2) 9 8 7

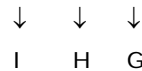

Similarly,

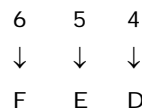

9. (1) B O R E



$2 + 15 + 18 + 5 = 40$

$40 \div 4 = 10$

H O T E L



$8 + 15 + 20 + 5 + 12 = 60$

$60 \div 5 = 12$

10. (3) I ⇒ 9 ; C ⇒ 3 ; 9 - 3 = 6

Similarly, D ⇒ 4 ; P ⇒ 16 ;

$16 - 4 = 12$

11. (3) N × M : 14 × 13

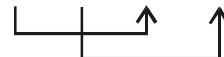

Position Number in the English alphabetical series.

Similarly,

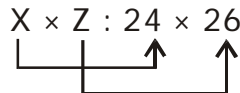

12. (3) C D → 3 4



Position Number of letter in the English alphabet.

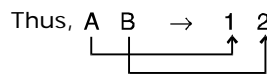

13. (3) B ⇒ 2

Position number in English alphabet

Now,  $(2)^4 = 2 \times 2 \times 2 \times 2 = 16$

Similarly,

$D \Rightarrow 4$

Now,  $(4)^4 = 4 \times 4 \times 4 \times 4 = 256$

**ANALOGY OR SIMILARITY**

14. (1)  $\frac{K}{T} \xrightarrow{\quad} \frac{11}{20}$  [Position in the

English alphabet]

Similarly,

$$\frac{J}{R} \xrightarrow{\quad} \frac{10}{18}$$

15. (4)  $\frac{K}{T} = \frac{11}{20} \xrightarrow{\quad} \frac{20}{11}$

Similarly,

$$\frac{G}{L} = \frac{7}{12} \xrightarrow{\quad} \frac{12}{7}$$

16. (2)  $C \Rightarrow 3 \times 9 = 27$

$L \Rightarrow 12 \times 2 = 24$

Similarly,

$E \Rightarrow 5 \times 9 = 45$

$N \Rightarrow 14 \times 4 = 56$

17. (3)  $\frac{Z}{26} : \frac{Y}{25} \Rightarrow$  Difference of 1.

Similarly,

$$\frac{B}{2} : \frac{A}{1}$$

18. (3)  $\frac{L}{S} : \frac{12}{19}$  [ Position Number  
in English alphabet ]

Similarly,

$$\frac{I}{T} : \frac{9}{20}$$

19. (4)  $M \Rightarrow 13$  and  $(13)^2 = 169$

$K \Rightarrow 11$  and  $(11)^2 = 121$

$$MK = \frac{169}{121}$$

Similarly,

$J = 10$  and  $(10)^2 = 100$

$H = 8$  and  $(8)^2 = 64$

Therefore,  $JH = \frac{100}{64}$

20. (2)  $C = 3$ ;  $3 \times 9 = 27 \Rightarrow \frac{24}{27}$   
 $L = 12$ ;  $12 \times 2 = 24 \Rightarrow \frac{24}{27}$

$E = 5$ ;  $5 \times 9 = 45 \Rightarrow \frac{56}{45}$

$N = 14$ ;  $14 \times 4 = 56 \Rightarrow \frac{56}{45}$

21. (3)  $C \xrightarrow{+6} I$

$3 \xrightarrow{+6} 9$

$F \xrightarrow{+6} L$

$6 \xrightarrow{+6} 12$

Therefore,

$K \xrightarrow{+6} Q$

$11 \xrightarrow{+6} 17$

$N \xrightarrow{+6} T$

$14 \xrightarrow{+6} 20$

22. (2)  $F \Rightarrow 6$ ;  $(6)^3 = 216$

Similarly,

$L \Rightarrow 12$ ;  $(12)^3 = 1728$

23. (2) R U S T

↓ ↓ ↓ ↓

9 6 8 7

Similarly,

T S U R

↓ ↓ ↓ ↓

7 8 6 9

24. (3) C A T

↓ ↓ ↓

3 1 20

Similarly,

M A T

↓ ↓ ↓

13 1 20

25. (4) Prize and the related field is given.

26. (4)  $T \Rightarrow 27 - 20 = 7$

$R \Rightarrow 27 - 18 = 9$

Therefore, ? = 999

27. (1)  $B \Rightarrow 2$ ;  $(2)^4 = 16$

Similarly,

$D \Rightarrow 4$ ;  $(4)^4 = 256$

28. (4)  $D \times H$

↓ ↓

$4 \times 8$

Similarly,

$M \times Q$

↓ ↓

$13 \times 17$

29. (4) 'Pride of Lions' is used for a group of Lions. Similarly, 'Clowder of cats' means 'a group of cats'

30. (1) Lucknow is the capital of Uttar Pradesh. Patna is the capital of Bihar. Bhopal is the capital of Madhya Pradesh. Jaipur is the capital of Rajasthan.

Similarly, Shimla is the capital of Himachal Pradesh.

31. (3) The zodiac sign virgo comes at the sixth place.

The number of players in a side in volleyball game = 6

A six is the highest score on a ball in the game of cricket. Extra sensory perception is referred to as sixth sense.

32. (2) The position of Y from the right end of the English alphabetical series is 2 and that of V is 5.

$(2)^2 = 4$  and  $(5)^2 = 25$

33. (4)  $P \Rightarrow 2$

$N \Rightarrow 4$

$L \Rightarrow 6$

$J \Rightarrow 8$

$P \xrightarrow{+1} Q \Rightarrow Q = 2 - 1 = 1$

$N \xrightarrow{+1} O \Rightarrow O = 4 - 1 = 3$

$J \xrightarrow{+1} K \Rightarrow K = 8 - 1 = 7$

$L = 6$  (It is given)

34. (3)  $\sqrt{AFI} = 13$

$\Rightarrow \sqrt{169} = 13$

Similarly,

$\sqrt{DDA} = \sqrt{144} = 12$